

SEARCHZONE SONIK™



Technical Manual

1 Preface

1.1 Introduction

Searchzone Sonik™ is a hazardous area certified advanced ultrasonic gas leak detector for detecting pressurized gas leaks. It provides local visual status indication as well as 4-20 mA with HART® and Modbus® outputs as standard. It has a Bluetooth® interface for configuration and maintenance using the Searchzone Sonik App on a suitable Bluetooth enabled smartphone or other suitable Android device (mobile device).

The Searchzone Sonik detector is ATEX and IECEx approved for use in either Zone 1 (gas) or Zone 21 (dust) hazardous areas as well as being cULus approved for use in Class I Division 1 or Class II Division 1 locations. See Certification and Approvals section of this manual for a list of certificates.

The Searchzone Sonik detector is available in painted Stainless Steel. It has two cable entries for easy wiring with either M25 or 3/4" NPT cable entries, dependent on the version.

1.2 Disclaimer

The Searchzone Sonik detector is designed to detect an airborne acoustic ultrasonic signature produced by escaping high pressure gas. The detector is not designed to identify the presence of any particular type of gas. It will detect the dangerous release of high pressure gas, whether toxic or flammable for the purpose of protecting people, plant and the environment. Honeywell shall not be liable to pay for any gas leak investigation or service call carried out or arranged in response to an alarm. Honeywell Analytics Limited can take no responsibility for installation and/or use of its equipment if this is not done in accordance with the appropriate issue and/or amendment of the manual. Please note that product designs may change from time to time and the images in this manual should only be used as a guide.

1.3 Scope

This user manual describes how to install the Searchzone Sonik detector and how to commission and operate it in order to ensure optimal performance.

1.4 How to Use This Manual

The manual is structured to cover the instrument, installation (mechanical and electrical), set-up and commissioning, operating and maintenance. This manual is available in PDF format .

1.5 Copyright & Trademarks

This document is the copyright of Honeywell.
Searchzone Sonik is a Honeywell trademark.

1.6 Patents

The Searchzone Sonik advanced ultrasonic gas leak detector uses patented sensing technology. Focus Mode, an operating mode of Searchzone Sonik is patent pending.

1.7 Revision History

Revision	Comment	Date
Issue 1	A05126	November 2018

Table of Contents

1 Preface	2
1.1 Introduction	2
1.2 Disclaimer	2
1.3 Scope	2
1.4 How to Use This Manual	2
1.5 Copyright & Trademarks	2
1.6 Patents	2
1.7 Revision History	2
2 Safety and Information	8
2.1 Warnings and Cautions	8
2.2 Important Information	9
2.3 Organisational Measures for Functional Safety	9
3 Overview and Introduction	10
3.1 Description of Product	10
3.2 Description of Function	10
3.3 Applications	10
3.4 Sensor Technology Description	10
3.5 Environmental Factors	10
3.5.1 Introduction to Background Noise and Interference	10
3.6 Range and Field of Coverage	11
3.6.1 Standard Mode	11
3.6.2 Focus Mode	12
3.7 Description of Gas Leak Detection Using Ultrasound	12
3.8 Mounting Accessories and Flexibility	12
3.9 Commissioning and Maintenance Tools	13
3.10 Available Accessories	14
4 Siting Considerations	15
4.1 Safety Case Framework	15
4.2 Siting the Detector	15
4.2.1 Mounting Position	16
4.2.2 Mounting Angle	16
4.3 Accidental Impact	16
4.4 Change in Site Infrastructure	16
4.5 Transient Background Noise	16
4.6 Location Survey	16

4.7	Bluetooth Considerations	17
5	Mechanical Installation	18
5.1	Visual Check after Transportation	18
5.2	Description	18
5.3	Main Parts	19
5.4	Mounting Searchzone Sonik	20
5.5	Pole Mount Installation	22
5.6	Wall Mount Installation	24
5.7	Assemble Cable Glands	25
5.8	Connect Cable Glands to the Searchzone Sonik	25
5.9	Detector Attachment	26
5.9.1	Detector removal	26
5.10	Connect Wires to PCB Terminals	28
5.11	Sunshade Installation	30
6	Electrical Installation	31
6.1	Power Supply Requirements	31
6.1.1	Internal Battery Cell	31
6.2	4-20 mA Current Loop	31
6.3	Relays	32
6.4	Connections / Wiring Diagram	32
6.4.1	Terminal Wiring Description	33
6.4.2	Searchzone Sonik Connection for mA loop Configuration as Current Source	34
6.4.3	Searchzone Sonik Connection for mA Loop Configuration as Current Sink	35
6.4.4	Searchzone Sonik Connection for mA Loop Configuration as Isolated Output	35
6.5	Cabling Recommendations	35
6.6	Earthing Recommendations	36
6.7	Modbus	36
7	Commissioning and Configuration	37
7.1	First Time Switch On	37
7.1.1	Pre-power Check	37
7.2	Operating Function Verification	37
7.3	Communication	37
7.3.1	Bluetooth®	37
7.4	Settings and Configuration	37
7.5	Delay Time	38
7.6	Background Noise Rejection	38
7.7	Performance Verification	38

8	Operation	39
8.1	Operation	39
8.2	Status Signalling	39
8.2.1	Visual Status Indicator	39
8.2.2	mA Loop Status	40
8.2.3	Relay Signalling	40
8.3	Normal Operation	40
8.4	Operation During Fault	40
8.5	Operation During Alarm	41
8.5.1	Pre-alarm	41
8.5.2	Alarm	41
8.5.3	Overload	41
9	Mobile App	42
9.1	General User Access	42
9.2	Terminology	42
9.3	Communications	43
9.3.1	Company Account Management	43
9.3.2	Creating a New Company Account	43
9.4	Connecting to Detectors	47
9.4.1	How to Connect to a Searchzone Sonik Detector	47
9.4.2	Making an Ad Hoc Connection to the Detector	49
9.5	Detector Overview	50
9.5.1	Detector Status	50
9.5.2	Detector Inhibit	51
9.6	Detector Alarm History	52
9.7	Detector Maintenance	53
9.7.1	Event Log	53
9.7.2	Set Maintenance Flag	54
9.7.3	Output Test	55
9.7.4	Diagnostics	56
9.8	Detector Settings	58
9.8.1	Firmware Version	59
9.8.2	Background Levels	60
9.8.3	Editing Detector Settings	61
9.9	How to Change Application Settings	64
9.9.1	Detector Registrations	64
9.10	User Management	65

10	Communications	67
10.1	HART®	67
10.1.1	Searchzone Sonik HART Interface	67
10.2	Menu Structure	68
10.3	Commissioning using HART Communications	72
10.3.1	User Configuration	73
10.3.2	Configure Warning, Inhibit and Over-range Signal Levels	73
10.3.3	Configure Device Identification Information	74
10.3.4	Test 4-20 mA Loop Integrity	75
10.3.5	Configure Internal Alarm Threshold	75
10.3.6	Clear Alarm Latch	75
10.4	Maintenance using HART Communications	76
10.4.1	Inspection	76
10.4.2	Proof Test (Gas Leak Challenge)	77
10.4.3	Investigation of Faults or Warnings	77
10.5	Modbus	78
10.5.1	Programming the Host	78
10.5.2	Addressing Conventions and Register Values	78
10.5.3	Modbus Cables	78
10.5.4	Modbus Electrical Connections	79
10.5.5	Modbus Termination Resistor	79
10.5.6	Modbus Multi-Drop Mode	79
10.5.7	Modbus Protocol	79
10.5.8	Modbus Registers	80
11	Maintenance	84
11.1	Inspection and Cleaning	84
11.2	Periodic Proof Test using a Canister of Compressed Air	84
11.3	Suggested Maintenance Schedule	84
11.4	Response to Fault	85
11.5	Product Life Expectancy	85
12	Problem Solving	86
12.1	Introduction	86
12.2	Problem Solving	87
13	Certification and Approvals	89
13.1	Hazardous Locations	89
13.2	ATEX Certification	89

13.3	IECEX Certification	89
13.4	CSA Certification	90
13.5	cULus Certification	90
13.6	Labelling	91
13.7	EU Declaration of Conformity	91
13.8	RoHS	91
13.9	China RoHS	92
13.10	WEEE	92
13.11	EMC	92
13.12	RED	92
13.13	REACH	92
13.14	FCC	92
13.15	IC	93
13.16	Export Compliance Classification	93
13.17	Wireless Approvals	93
13.18	Bluetooth®	93
14	Ordering Information	94
15	Specifications	95
15.1	Short Form Table	95

2 Safety and Information

2.1 Warnings and Cautions

WARNING

1. Installation must be in accordance with the recognized standards of the appropriate authority in the country concerned. For Europe see EN 60079-14 and EN 60079-29-2.
2. Installation, operation and maintenance of the unit must meet requirements on safety and operation in hazardous areas.
3. The equipment is NOT intended to be mounted onto surfaces which may act as sources of heating or cooling.
4. Do NOT operate the unit outside the temperature range stated in the Specification section.
5. Do NOT open the front enclosure. Doing so will invalidate the warranty.
6. Operators should be fully aware of the action to be taken in the event of an alarm.
7. Do NOT modify or alter the construction of the product as essential safety and certification requirements may be invalidated.
8. Installation, set-up and maintenance must be conducted only by trained personnel. Refer to the manual at all times.
9. Access to the interior of the product, when carrying out any work, must be conducted only by trained personnel.
10. In order to maintain electrical safety, the unit must NOT be operated in atmospheres of more than 21% oxygen.
11. The plastic transport cap supplied must be replaced with suitably certified closers (such as glands or stopping plugs) prior to commissioning. Failure to do so presents a potential source of ignition. One certified stopping plug is supplied as standard.
12. Do NOT rely on the local visual indicator for safety related purposes.

CAUTION

If the time in which a user logs in to the Searchzone Sonik App in the online mode **exceeds 1 year**, it will be necessary to establish an Internet connection to the mobile device and log in to the App in order to refresh the detector's security certificate.

Items of Disposal

Enclosure	Painted 316 Grade Stainless Steel
Standard Adjustable Mounting Bracket	Stainless Steel
Sunshade	Plastic / Stainless Steel (optional)



This symbol indicates that this product and/or parts of the product may not be treated as household or municipal waste. Waste electrical products (end of life) should be recovered/ recycled where suitable specialist WEEE disposal facilities exist. For more information about recycling of this product, contact your local authority, our agent/distributor or the manufacturer.

2.2 Important Information

This manual is for use with the Honeywell Searchzone Sonik advanced ultrasonic gas leak detector only.

Honeywell Analytics can take no responsibility for installation and/or use of its equipment if not done so in accordance with the appropriate issue and/or amendment of this Manual.

The reader of this Manual should ensure that it is appropriate in all details for the exact equipment to be installed and/or operated. If in doubt, contact Honeywell Analytics for advice.

The following types of notices are used throughout this Manual.

WARNING

Identifies a hazardous or unsafe practice which could result in severe injury or death to personnel.

CAUTION

Identifies a hazardous or unsafe practice which could result in minor injury to personnel, or product or property damage.

Note

Identifies useful/additional information.

Every effort has been made to ensure the accuracy of this document, however, Honeywell Analytics can assume no responsibility for any errors or omissions in this document or their consequences.

Honeywell Analytics would greatly appreciate being informed of any errors or omissions that may be found in the content of this document.

For information not covered in this document, or if there is a requirement to send comments/corrections about this document, please contact Honeywell Analytics using the contact details given on the back page.

Honeywell Analytics reserve the right to change or revise the information supplied in this document without notice and without obligation to notify any person or organization of such revision or change. If information is required that does not appear in this document, contact the local distributor/agent or Honeywell Analytics.

2.3 Organisational Measures for Functional Safety

Refer to the Searchzone Sonik *Safety Manual* for more information.

3 Overview and Introduction

3.1 Description of Product

The Searchzone Sonik is an advanced ultrasonic gas leak detector for use in hazardous areas. It detects high pressure gas leaks within the protection area, in order to provide an early alert to a hazard. While the Searchzone Sonik does not indicate the type of gas, it will respond to any high pressure gas leak within the coverage area and so will protect against the release of dangerous gases, whether they be toxic or flammable.

With conventional gas detectors, the escaping gas has to reach the detection point or line between a transmitter/receiver pair. The Searchzone Sonik ultrasonic gas leak detector recognizes sound emitted by the leak from a distance, without the released gas having to reach the detector.

3.2 Description of Function

The Searchzone Sonik detects pressurised gas leaks by sensing the airborne acoustic ultrasonic sound pressure wave and signature produced by the escaping gas. The detection method uses a robust patented piezo-based sensor which will function in extreme weather conditions, on and offshore. With no moving parts and no sensor cover required, the Searchzone Sonik can withstand adverse conditions including pressure wash-down. The detector does not require field calibration, only periodic bump testing, which can be accomplished from ground level. Interfacing for set-up, commissioning and maintenance can be achieved wirelessly using the Searchzone Sonik App, running on a suitable Bluetooth-enabled mobile device.

3.3 Applications

The Searchzone Sonik detector is ideal for detecting gas leaks from units such as metering skids, compressors, pumps, valves and pipework flanges in complex and congested distribution, process and transmission systems.

3.4 Sensor Technology Description

The Searchzone Sonik detector employs an advanced ultrasonic sensor module that is robust and reliable even in harsh environmental and operational conditions. The sensor module has a very long life in these adverse conditions and does not require field calibration. The sensor detects the ultrasonic sound pressure waves, which are longitudinal vibrations that propagate through the air. Upon entering the sensor structure, the sound pressure waves create a voltage across the transducer, which is then amplified and processed using advanced detection algorithms. The patented piezo-based ultrasonic sensor module is robust with minimal failure modes.

3.5 Environmental Factors

The leak detection range is limited by the atmospheric absorption of the ultrasound. This absorption increases with frequency. The Searchzone Sonik will detect specified gas leaks typically up to 20m in all conditions. Background noise levels also have an effect on the detection range. Process equipment which generates ultrasonic noise will need to be considered when setting the detection thresholds of the detector, which can cater for high, medium and low levels of background noise. The detection range of the detector will be maximal at lower levels of background ultrasonic noise. Typical sources of background noise include rotating machinery, clanking chains, steam whistles and other steam release mechanisms, air horns as well as intentional gas releases.

Note

Ice build-up on the face of the sensor will cause an increase in sensitivity, which may lead to an increase in nuisance alarms. When mounting in locations where ice build-up is likely, take necessary precautions in protecting the unit against such build-up and/or setting of alarm levels.

3.5.1 Introduction to Background Noise and Interference

The frequency of the noise being produced by the source will also have a bearing on the measurement range since the attenuation co-efficient of sound in air increases with frequency. This not only affects the sound pattern generated by a gas leak but also that generated by other sources of ultrasonic noise and they differ. The Searchzone Sonik detection is optimized to detect gas leaks in real

world conditions. The sound pressure level generated by a high pressure gas leak is dependent upon the pressure, the leak diameter, and upon the gas density. The Searchzone Sonik detector is designed to detect hazardous high pressure leaks.

As a guide, the following table indicates typical maximum detection ranges that can be achieved for various levels of background ultrasonic noise.

Detection Threshold Level	64 dB (Low)	74 dB (Mid)	84 dB (High)
Standard Detection Mode	24 m	12 m	7 m
Focus Detection Mode	7 m	5 m	3 m

Note

Due to variances sound level intensity generated across the measured frequency range and angular positioning of the detector. The above values may vary up to 50%.

The values in the table above were achieved with a methane leak, mass flow rate of 0.1 kg/s at an environment of 20°C, 50 %RH and a standard atmospheric pressure of 1013 hPA.

Note

The Background Levels feature, available in the Searchzone Sonik mobile App, can be used to validate and check that the current detector settings are appropriate. Refer to section 9.9 *Detector Settings* for more information.

3.6 Range and Field of Coverage

The Searchzone Sonik detector has a dynamic range of 40dB to 140 dB giving a detection range of typically 20m on-axis radius (background noise dependant). The field of detection coverage (FoC) is +/-90 degrees in both horizontal and vertical planes measured on-axis to the face of the detector's sensor.

The detection algorithms (Standard or Focus) differentiate between leak signatures and typical noise source signatures in both time and frequency domains. The polar plots in the Figures 3 and 4 below show the typical detection areas for both Standard and Focus modes. Refer to the table in section 3.5.1 for typical ranges that can be achieved for both Standard Mode and Focus Mode.

3.6.1 Standard Mode

Use Standard Mode for larger areas which are subject to lower levels of background noise and where nuisance alarms sources are not expected.

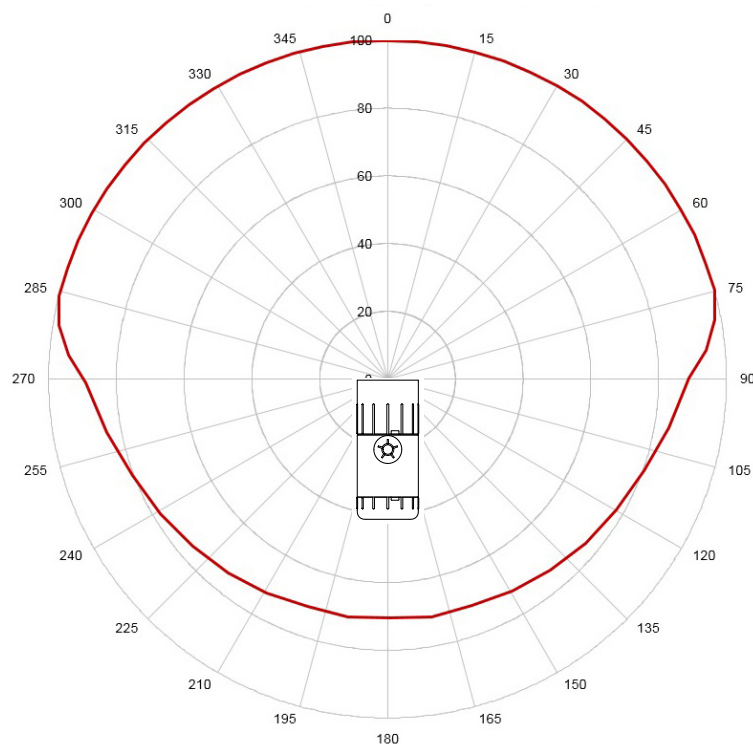

Figure 3. Angular Field of Coverage in Standard Mode (% of Range)

3.6.2 Focus Mode

Use Focus Mode for closer areas which are subject to high levels of background noise and where nuisance alarm sources are expected.

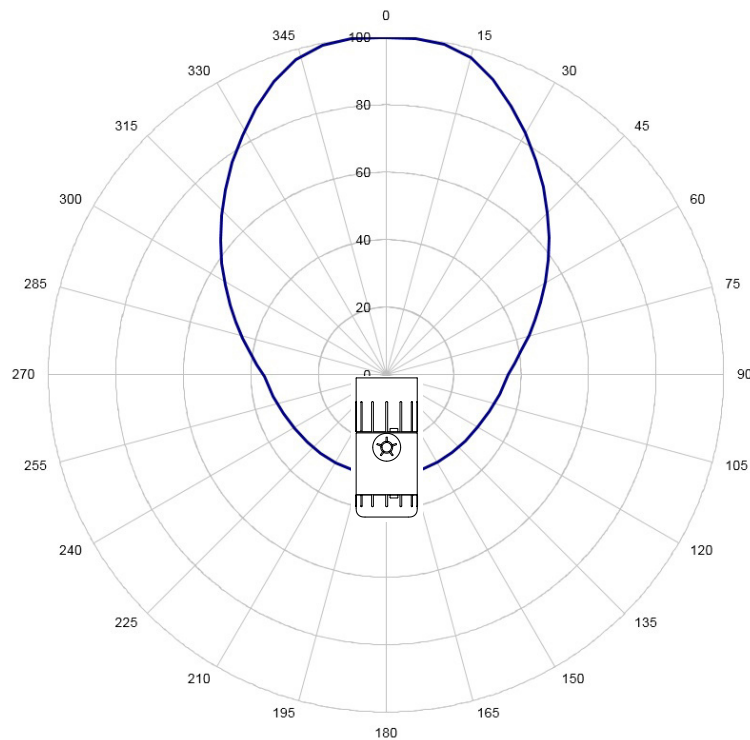

Figure 4. Angular Field of Coverage in Focus Mode (% of Range)

3.7 Description of Gas Leak Detection Using Ultrasound

A high pressure gas leak is a broadband continuous phenomenon. This gas leak ultrasound signature is detected in the presence of other ultrasound noise sources using advanced detection algorithms. The detection algorithms differentiate between leak signatures and typical noise source signatures in both time and frequency domains.

3.8 Mounting Accessories and Flexibility

The Searchzone Sonik detector is supplied with the Standard Adjustable Mounting Bracket that can be simply installed prior to the fitting of a Searchzone Sonik detector. The 3-axis adjustment allows the detector to be aimed precisely and has graduated angles marked on the adjustments. The Standard Adjustable Mounting Bracket allows simple fixing onto a range of surfaces as well as poles, struts, plates and other plant infrastructure. It is manufactured from high quality Stainless Steel.

LEGEND:

- Adjusting range in the vertical axis (A) = 0° to 90°
- Adjusting range in the horizontal axis (B) = -45° to +45°
- Adjusting rotational range (C) = -45° to +45°
- Graduated adjustment in 5 degree steps
- Graticule for easy setting

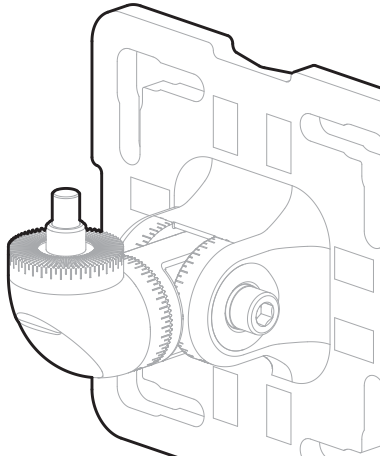

Figure 5. Standard Adjustable Mounting Bracket

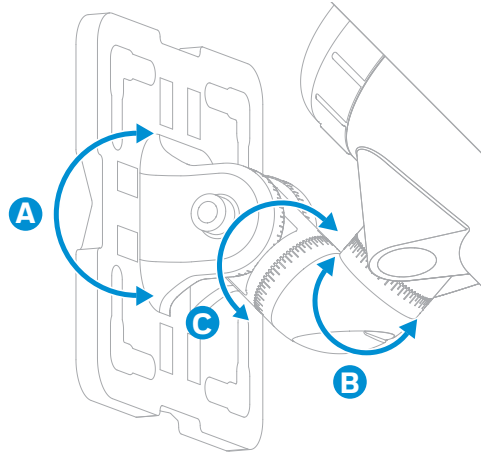

Figure 6. Adjustment ranges

3.9 Commissioning and Maintenance Tools

The Searchzone Sonik Mobile App is an Android-based application downloadable from Google Play. It connects via Bluetooth to the Searchzone Sonik detectors and is the primary tool for installation, commissioning and maintenance.

The HART and Modbus protocols provide additional means of communicating with Searchzone Sonik for the purpose of installation, commissioning and maintenance.

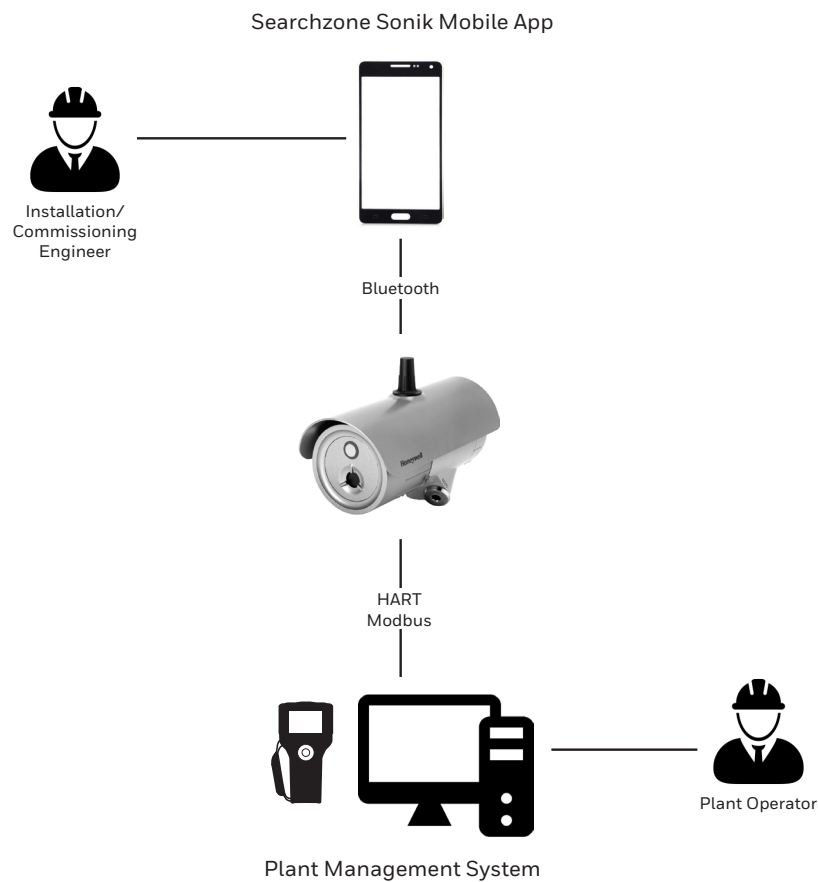

Figure 7. Searchzone Sonik communication diagram

3.10 Available Accessories

The Standard Adjustable Mounting Bracket and a Plastic Sunshade are provided as standard. The following items are available as optional accessories. Refer to the *Ordering Information* section of this manual for more information:

1. Large Adjustable Mounting Bracket
2. Stainless Steel Sunshade
3. Hazardous Area Mobile Phone
4. Searchzone Sonik App

4 Siting Considerations

When designing an installation for a Searchzone Sonik detector it is important to give due consideration as to where it is to be located, what potential sources of problems that may be encountered in the intended location and how the detector is to be mounted.

Users are strongly recommended to consult with experts who are experienced in site mapping and siting of ultrasonic gas leak detectors when determining final positioning.

4.1 Safety Case Framework

In compliance with IEC 61508, IEC 61511 and EEMUA recommendations, the Safety Case Framework is used as a method of reducing risks at hazardous installations to acceptable levels. The framework is based on the concept of Layers of Protection which is widely recognized by the process industry and clearly defined in industry safety standards.

Considering the application of all types of the protection layers – some layers are preventative (e.g., emergency shut down), while some are there to mitigate the impact of an incident should it occur (e.g., fire and gas protective systems or plant emergency response systems). Other layers of protection can counter occurrence of incidents in the first place (e.g., plant and physical asset protection, constraint and boundary management, operator training, and asset management); while others can provide detection and alerting, and associated guidance (e.g., operator alarms, early event detection, and integrated operator procedures). Layers can either be automated, such as emergency shut down (ESD) equipment, or require human interaction such as operator responses to process alarms. Some layers offer easily quantifiable risk-reduction benefits but require that the risks all be identified before. And still others are less tangible and offer subtler benefits.

An Advanced Ultrasonic Gas Leak Detector will generally be used as part of a Gas Detection and Mitigation layer. Ultrasonic gas leak detectors complement point and open path gas detectors as they detect the gas leak by sensing the sound pressure level created by a high pressure gas leak. Ultrasonic gas leak detectors are affected by environmental conditions but not significantly by wind.

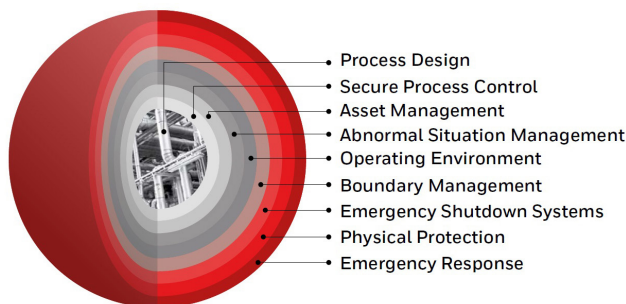

4.2 Siting the Detector

CAUTION

1. Do NOT install in areas where detector can be struck by falling objects.
2. Do NOT site the detector where maintenance may impact, misalign or damage the detector.
3. Avoid installing on a vibrating infrastructure.
4. Install the detector a minimum of 1 m away from potential source of gas leak. Point the detector 30 degrees away from the potential source of gas leak.
5. A detector installed a minimum of 3 m away from a potential source of gas leak may be aimed directly at it.
6. Do NOT operate the detector outside of the allowed temperature range. Refer to the *Specification* section of this manual for more information.

4.2.1 Mounting Position

It is recommended that Searchzone Sonik is placed close to the area to be protected to maximise the detection performance. For best performance, use the following location principles when determining final positioning of the detector:

- Avoid situations where a leak plume is presented directly to the face of the detector. For best results, aim the detector at the potential leak but at an angle of approximately 30 degrees off axis of the resultant plume.
- When monitoring a pipe containing the pressurized gas, mount the detector so that it 'looks' along the pipe.
- Avoid mounting the detector directly next to or over sources of ultrasonic noise e.g. compressor, gearbox, turbine, generator, etc.
- Do not install the detector next to pressurized air lines and fittings.
- Positioning the detector away from sources of unwanted ultrasonic noise will significantly reduce the risk of nuisance alarms.

4.2.2 Mounting Angle

It is recommended that Searchzone Sonik is mounted pointing downwards by at least 30 degrees when used outdoors to allow the sunshade to protect the sensor from the adverse environmental conditions.

4.3 Accidental Impact

Situations where there is a significant probability of equipment, personnel or moving objects accidentally impacting Searchzone Sonik detector should be avoided. If such locations cannot be avoided, measures including increase mechanical protection and warning notices should be considered.

4.4 Change in Site Infrastructure

When there are changes in site infrastructure or configuration, which may introduce new sources of ultrasound, the customer should review the existing configuration of Searchzone Sonik detectors and decide if it needs to be adapted to suit those changes.

4.5 Transient Background Noise

Transient background noise from processes that release gas or steam under pressure (e.g., planned release of gas intended by the operator) can cause unwanted triggering of an ultrasonic gas leak detector. These can be avoided by setting an alarm delay which is longer than duration of that process operation.

4.6 Location Survey

Points of consideration:

- 1) Assess the Risk Case
 - a. What is the risk?
 - b. What is the anticipated gas leak sound pressure level ?
 - c. What is the protection method?
 - d. What is the detection method in case of a leak?
 - e. How best to mitigate the risk?
- 2) Assess the environmental conditions before installation
- 3) Assess the potential sources of background noise in the area
If necessary measure these at the proposed ultrasonic gas leak detector install position
- 4) Assess the area to be covered by an ultrasonic gas leak detector with respect to:
 - a. Type of working environment
 - b. Local sources of ultrasounds
- 5) Choose an appropriate distance of the detector from the monitored area. Avoid installing the detector at or close to maximum range to allow higher detection thresholds to be set, reducing the risk of false false alarms. See coverage diagrams specified in *Overview and Introduction* section of this manual.

- 6) Choose Standard or Focus Mode with respect to the expected background noise levels and the nature of the risk to be covered. Refer to the *Overview and Introduction* section of this manual for more information.
- 7) Choose the detector's mounting position and angle, considering
 - a. Coverage
 - b. Ease of access
 - c. The direction of any potential leak. Refer to section 4.2.1 *Mounting Position*.
- 8) Ensure that the risk of physical impact, misalignment, or damage of the detector by human factor or uncontrollable events is avoided

4.7 Bluetooth Considerations

1. Is use of Bluetooth permitted on the site?
2. Is the mobile device rated for operation in hazardous locations?
3. Is the Searchzone Sonik installed within 20 m from the place where operator will stand?
4. Is there direct visibility ensured between the Searchzone Sonik and the mobile device?

5 Mechanical Installation

5.1 Visual Check after Transportation

The Searchzone Sonik pack includes:

- The Searchzone Sonik Gas Leak Detector
- Standard Adjustable Mounting Bracket
- Plastic Sunshade
- One certified blanking plug
- Tool Kit

To ensure that the Searchzone Sonik unit was not damaged during transport, perform the following checks:

1. Check the packaging for damage before opening. If the packaging shows signs of tearing, breakage or other damage, immediately inform the transport company and the supplier. Document the damage in an appropriate way (e.g., photographs).
2. Open the packaging carefully to avoid damaging the contents.
3. Examine the Searchzone Sonik detector for damage. If you find the detector to be damaged in any way, immediately inform the transport company and the supplier. Document the damage in an appropriate way (e.g., photographs).
4. In the case of damage:
 - a) Leave the detector in the original packaging
 - b) Do not attempt repair, or operate the detector until the damage claim has been resolved with the supplier.

CAUTION

1. Installation, set-up and maintenance must be conducted only by trained and authorized personnel.
2. Do NOT open the front enclosure. The warranty of a unit, whose front enclosure has been opened, is invalidated.
3. Do NOT modify the front enclosure or component parts as this will compromise the hazardous location certification and invalidate the warranty.
4. Do NOT modify the construction of the detector in any way as this will invalidate the warranty.
5. Open and close the wiring compartment cover with care to avoid deformation.
6. Installation, set-up and maintenance must be conducted only by trained and authorized personnel.
7. Avoid water and dust ingress when opening the wiring compartment to protect the unshielded electronic contacts.
8. Secure the detector when loosening bracket bolts. Unwanted release may cause injury.
9. Check mating surfaces prior to assembly (threads, O-rings). Ensure that they are clean and free of contaminants.
10. Check the O-rings prior to assembly, replace if damaged with genuine parts.
11. The Searchzone Sonik is supplied without cable glands. Ensure that all cable entry threads are sealed with an appropriate plug to eliminate water ingress and thread damage. At installation, the cable entry transportation plugs must be removed and replaced with suitable cable glands, thread adapters or blanking plugs to meet local hazardous location requirements.
12. Check suitability of the blanking plug for its end use on site, ensure it meets local and national regulations.
13. Remove power from the Searchzone Sonik detector while installing wiring. Do NOT install wires or set up wiring with power applied.

5.2 Description

The Standard Adjustable Mounting Bracket enables Searchzone Sonik to be fitted to a wide range of plant infrastructure and then appropriately aimed to cover the area to be protected. It is manufactured in 316L Stainless Steel.

A Large Adjustable Mounting Bracket is available as option to suit installation on larger diameter poles.

Searchzone Sonik cable entries are 2 x M25 or 2 x 3/4" NPT dependent on the version.

The two compartment design means that the sensing electronic module and wiring compartment are separate. There are no set-up switches within the electronics.

Two pluggable connectors are provided within the wiring compartment. The connectors feature mechanical retention.

5.3 Main Parts

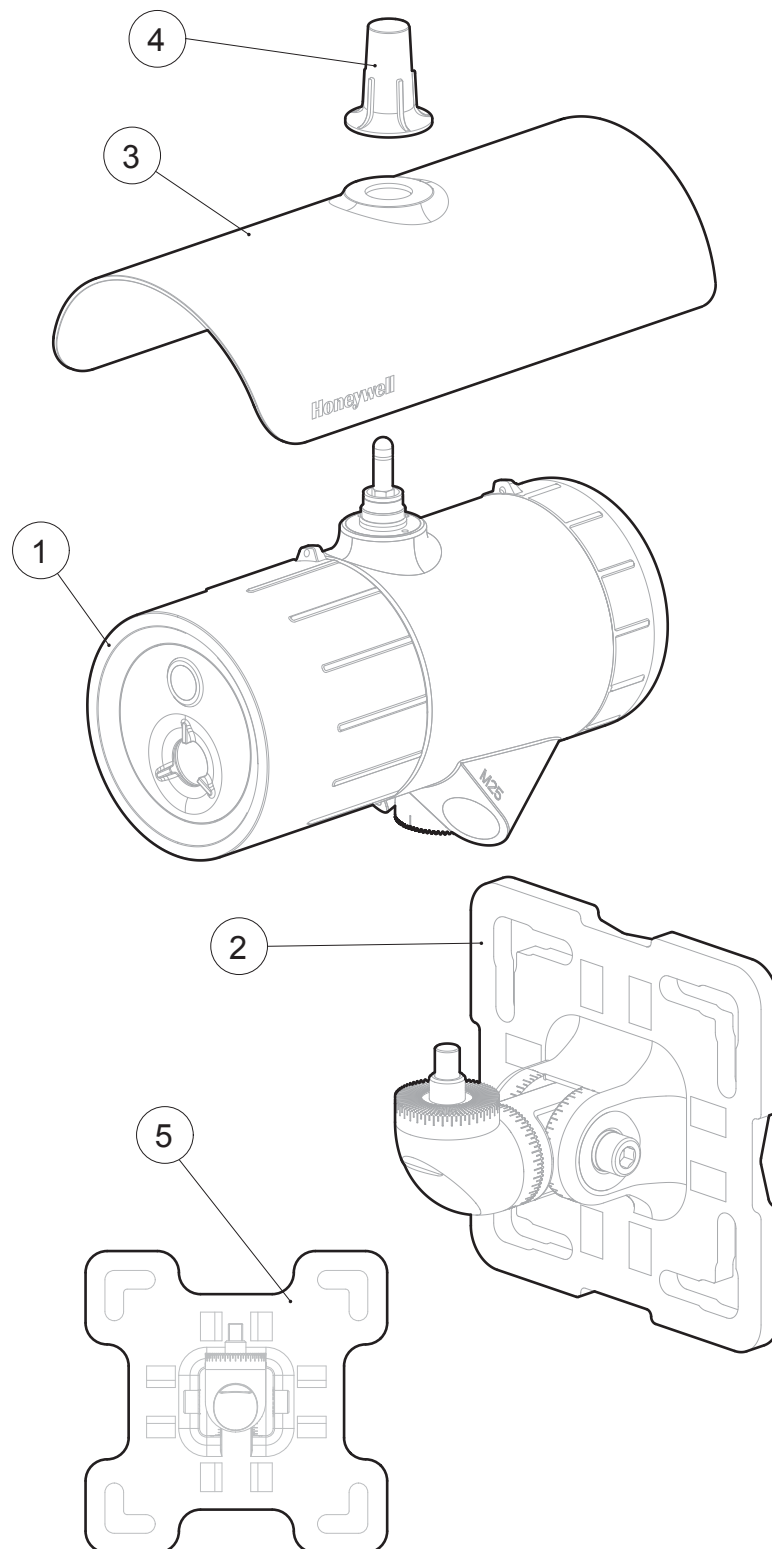

Figure 8. Searchzone Sonik general view

LEGEND:

1. Searchzone Sonik Advanced Gas Leak Detector
2. Standard Adjustable Mounting Bracket to fit on a plate, pole or plant infrastructure
3. Sunshade
4. Antenna cover
5. Large Adjustable Mounting Bracket (optional)

5.4 Mounting Searchzone Sonik

Searchzone Sonik will normally be mounted at height, typically secured to a pole using the U-Bolts or Worm Drive Clips supplied in the Pole Installation Kit (optional).

The supplied Standard Adjustable Mounting Bracket allows mounting on a plate, pole or other plant infrastructure. All bolts are captive to avoid accidental loss during installation.

CAUTION

IMPORTANT: When tightening the pivot bolts, **first, tighten the left-facing** horizontal M10 bolt to fix the pivot in its horizontal position. **Second, tighten the right-facing** horizontal M10 bolt. Tighten these bolts to a final torque of 30 Nm/22 lb.ft.

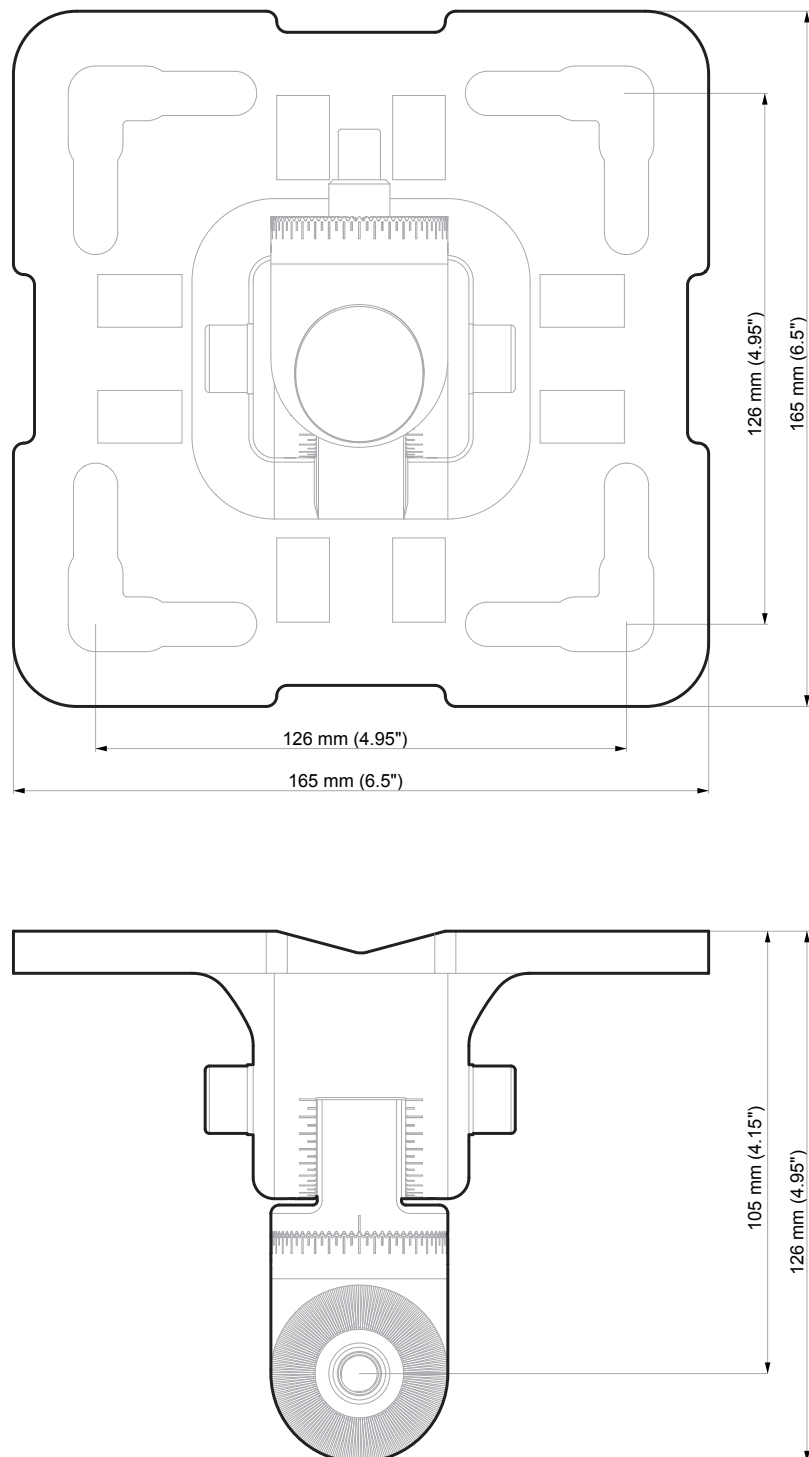

Figure 9. Standard Adjustable Mounting Bracket general view and dimensions

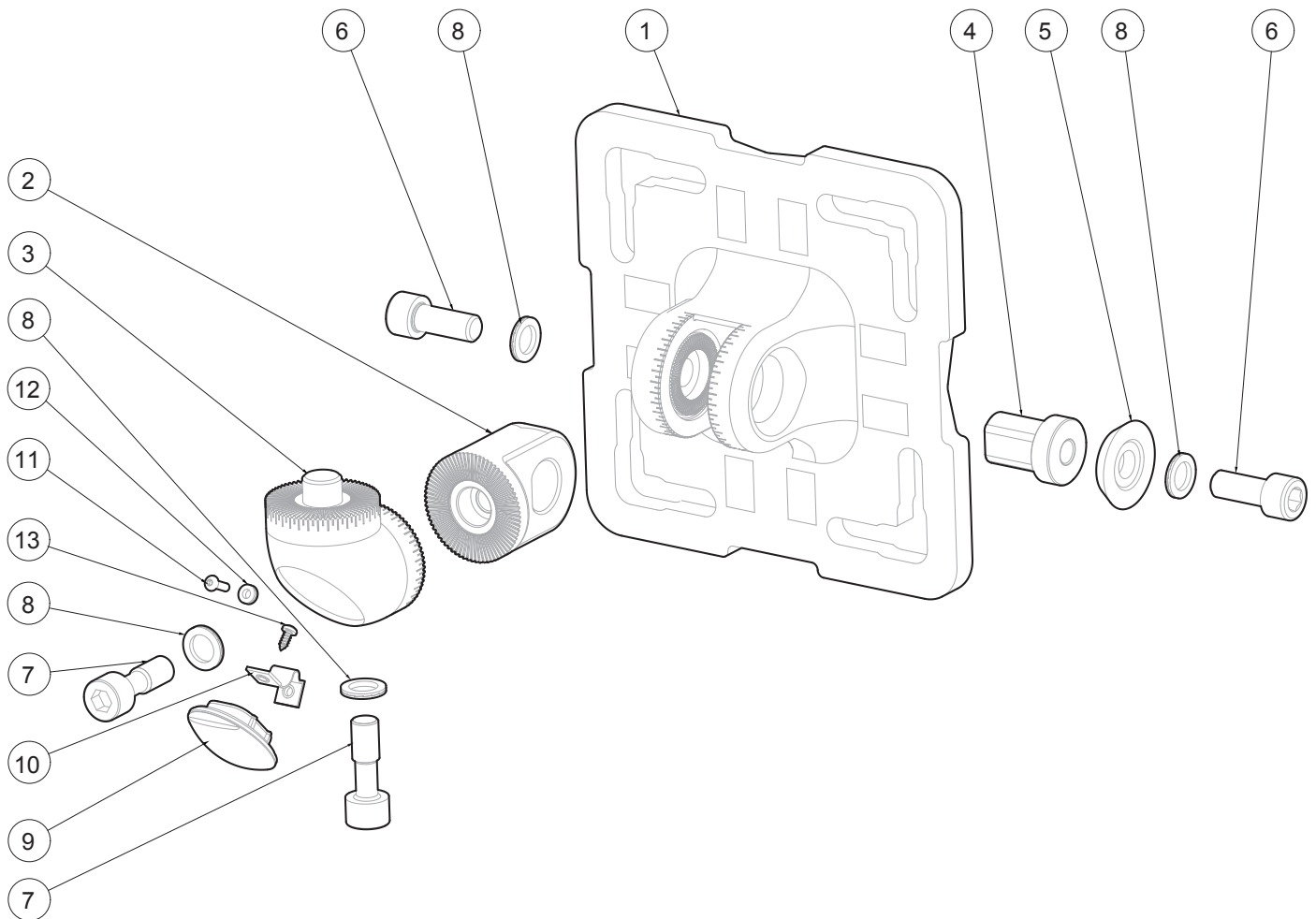

Figure 10. Standard Adjustable Mounting Bracket exploded view

LEGEND:

Position	Description	Pcs.
1	Standard Adjustable Mounting Bracket flange	1
2	Vertical pivot	1
3	Horizontal pivot	1
4	Keyed insert	1
5	Conical washer	1
6	Bolt M10x25	2
7	Captive Bolt M10x30	2
8	Nord lock washer M10	4
9	Bolt cover plate	1
10	Plate retention strap	1
11	Bolt M3x10	1
12	Nord lock washer M3	1
13	Retention strap screw	1

5.5 Pole Mount Installation

For pole installation, use the optional Pole Mount Fixing Kit. Refer to the *Ordering Information* section of this manual.

1. For poles 50 to 101 mm (2 to 4 inches) in diameter use the supplied Standard Adjustable Mounting Bracket.
2. For larger poles 101 to 152 mm (4 to 6 inches) in diameter use the Large Adjustable Mounting Bracket (optional; Refer to section 14 *Ordering Information* of this manual.)
3. Attach the assembled Standard Adjustable Mounting Bracket (or Large Adjustable Mounting Bracket) to the pole. Align the bracket flange V-groove with the pole for a good fit. Fix the bracket with two U-bolts and four nuts with washers. Alternatively, fix the bracket using the Worm Drive Clips. Refer to the figure below.
4. Unscrew both horizontal M10 bolts by 2-3 turns.
5. Adjust the pivot in horizontal position.
6. **IMPORTANT: First, tighten the left-facing** horizontal M10 bolt (refer to the figure below) to fix the pivot in horizontal position (torque 30 Nm/22 lb-ft).
7. **IMPORTANT: Second, tighten the right-facing** horizontal M10 bolt (refer to the figure below) to fix the pivot in horizontal position (torque 30 Nm/22 lb-ft).

CAUTION

Use of the Worm Drive Clips is NOT recommended for installation on moving objects, e.g., gas carriers.

NOTE

All Mounting Bracket bolts are captive to ensure that they are not accidentally dropped during installation.

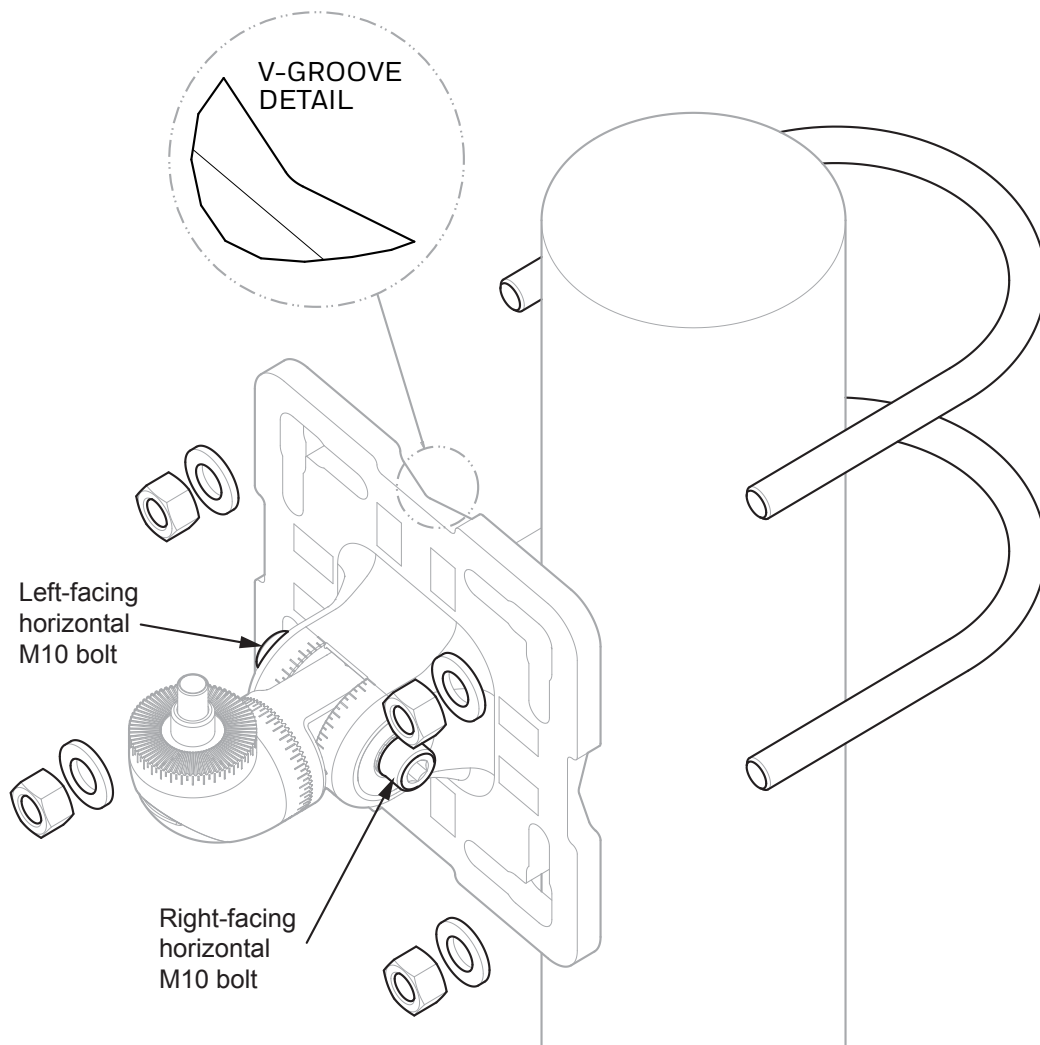

Figure 11. Standard Adjustable Mounting Bracket fitment to pole with U-bolts

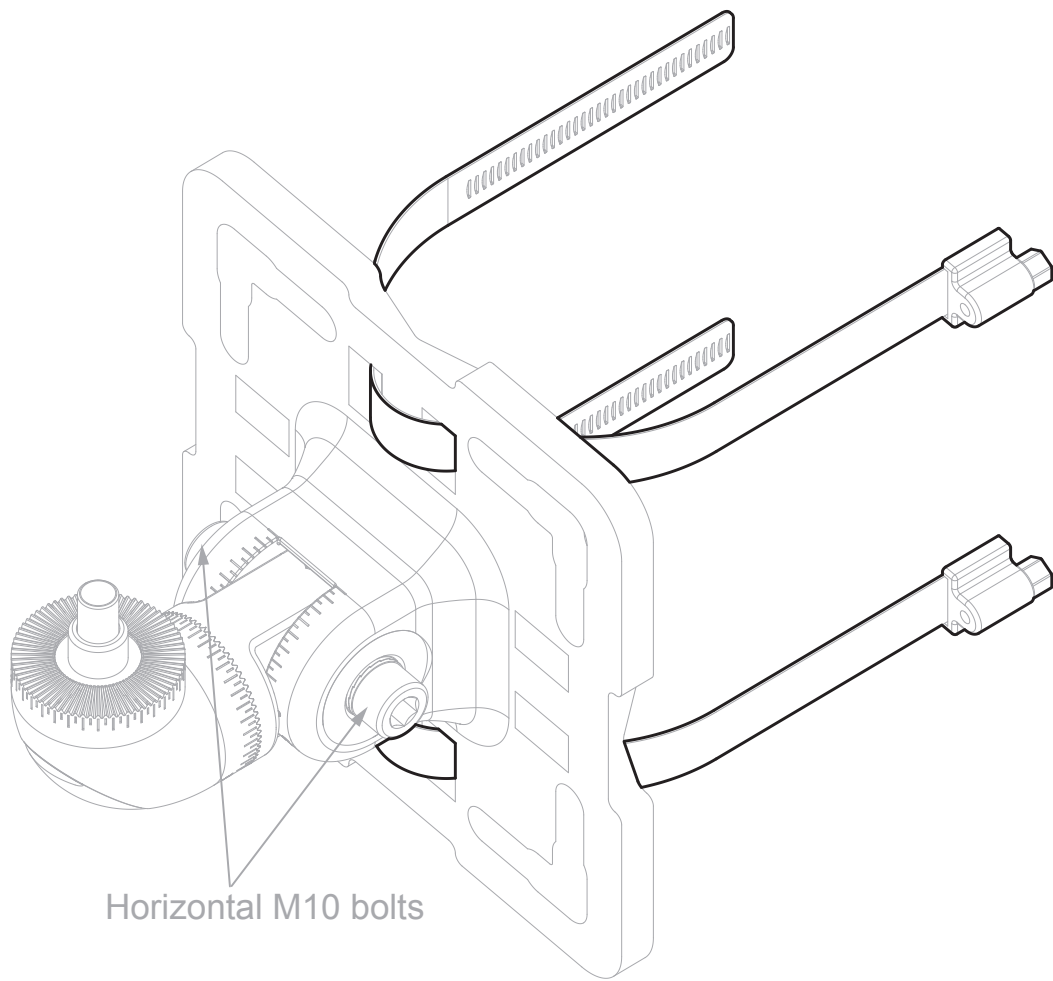

Figure 12. Standard Adjustable Mounting Bracket fitment using Worm Drive Clips

5.6 Wall Mount Installation

For installation onto a wall, use M8 or M10 mounting bolts with washers (not supplied).

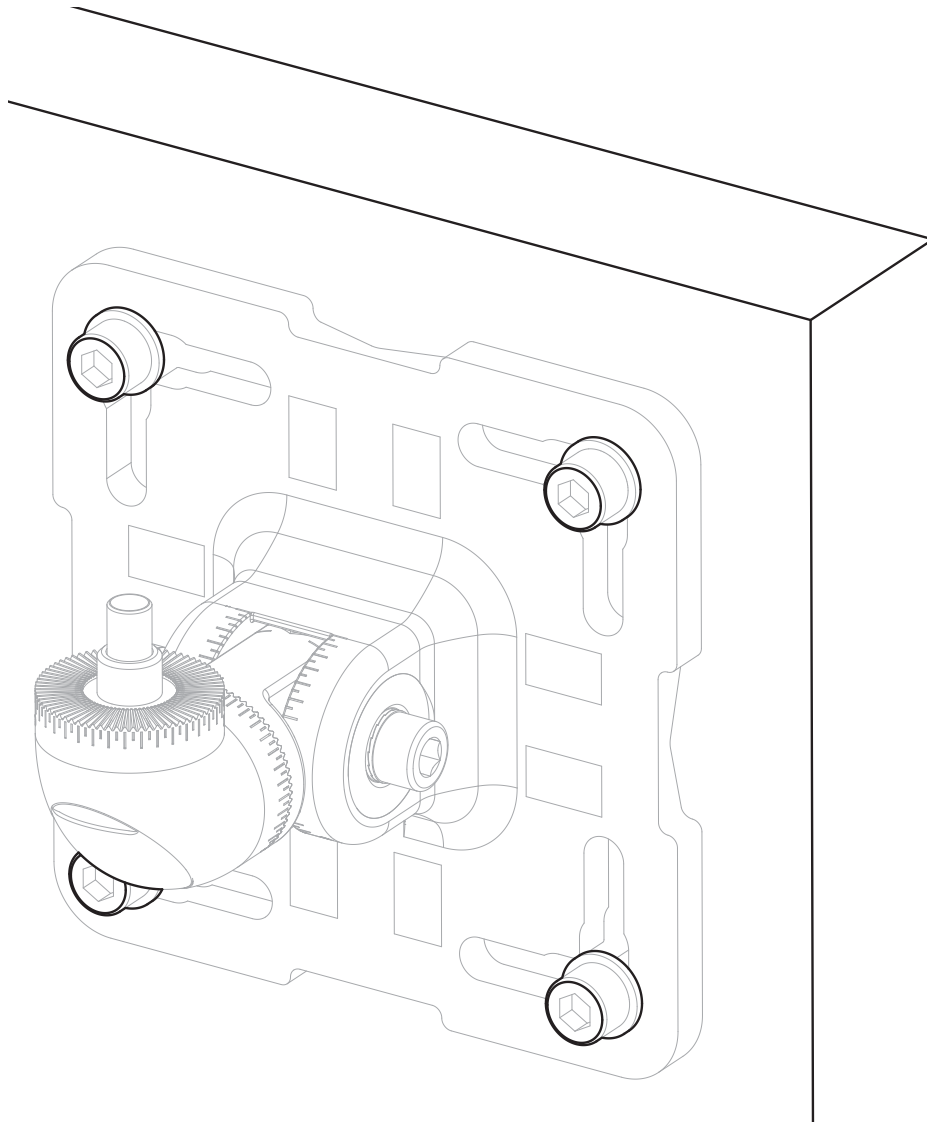

Figure 13. Wall mount installation

5.7 Assemble Cable Glands

Refer to the original manufacturer's assembly instructions for the particular cable gland type. The wiring compartment is certified to be able to use EX d or Ex e glands to suite local requirements. Leave a service loop in the cable as per site standard procedures.

NOTE

Use certified cable glands and blanking plugs as per local standards.

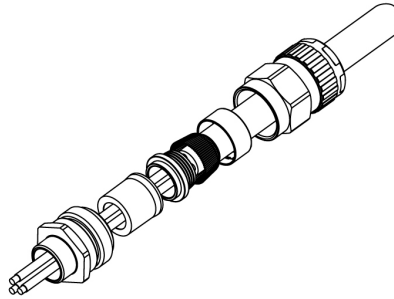

Figure 14. Example of cable gland

5.8 Connect Cable Glands to the Searchzone Sonik

1. Fit the cable glands to the Detector.
2. Fit a Stopping Plug to any unused cable entry.
3. Tighten the gland nuts and Stopping Plugs as per the manufacturer's instructions.

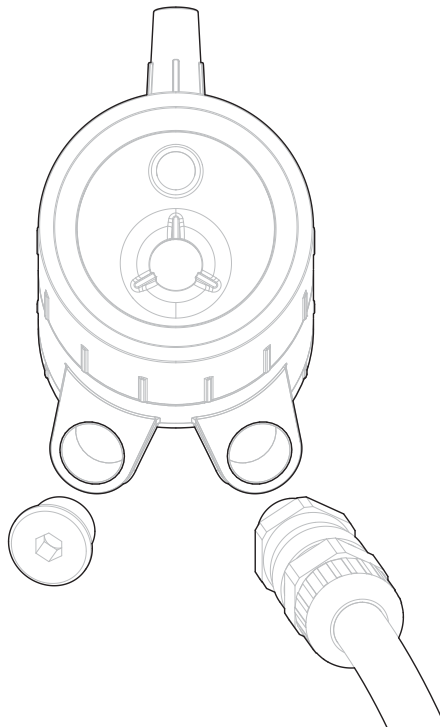

Figure 15. Connect cable glands to the Detector

5.9 Detector Attachment

1. Remove the bolt cover plate (refer to the figure below).
2. Attach the Searchzone Sonik to Standard Adjustable Mounting Bracket.
3. Hold in place and hand-tighten the vertical M10 bolt with washer. The Standard Adjustable Mounting Bracket is designed so that Searchzone Sonik sits on the top spigot and is balanced to aid installation.
4. Aim the detector in the desired direction and hand-tighten the **left-facing** horizontal M10 bolt. Only hand fit the **right-facing** horizontal M10 bolt at this stage.
5. Check the final positioning of the detector and make adjustments if necessary.
6. Tighten only the **left-facing** horizontal M10 bolt to a final torque of 30 Nm (22 lb ft).
7. Tighten the remaining bolts to a final torque of 30 Nm (22 lb ft).
8. Push home the bolt cover plate.

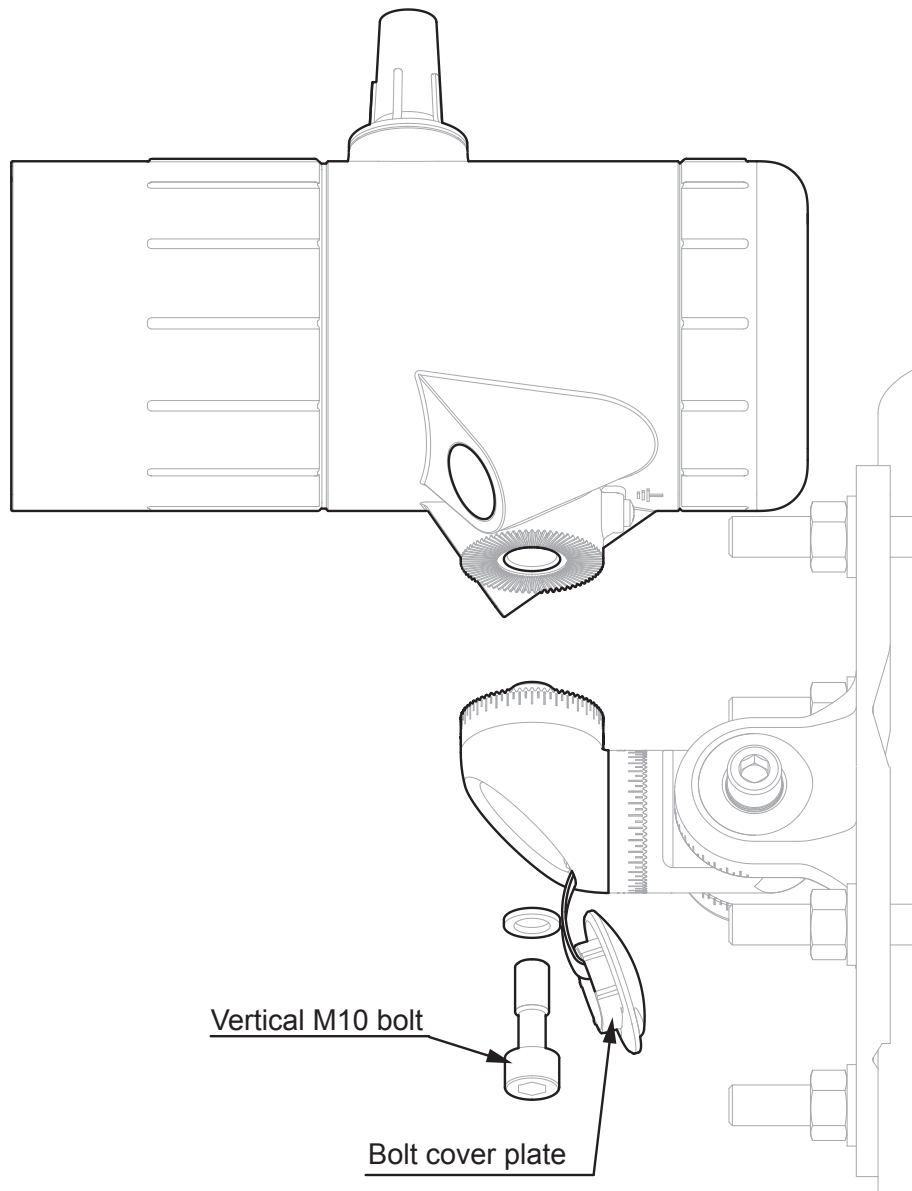

Figure 16. Detector attachment

5.9.1 Detector removal

1. **IMPORTANT:** First, loosen the right-facing horizontal M10 bolt by 2-3 turns.
2. **IMPORTANT:** Second, loosen the left-facing horizontal M10 bolt by 2-3 turns.
3. Set the vertical position of Detector to 0°.
4. Hold the detector body and loosen the vertical M10 bolt.
5. Remove the Searchzone Sonik from Standard Adjustable Mounting Bracket.

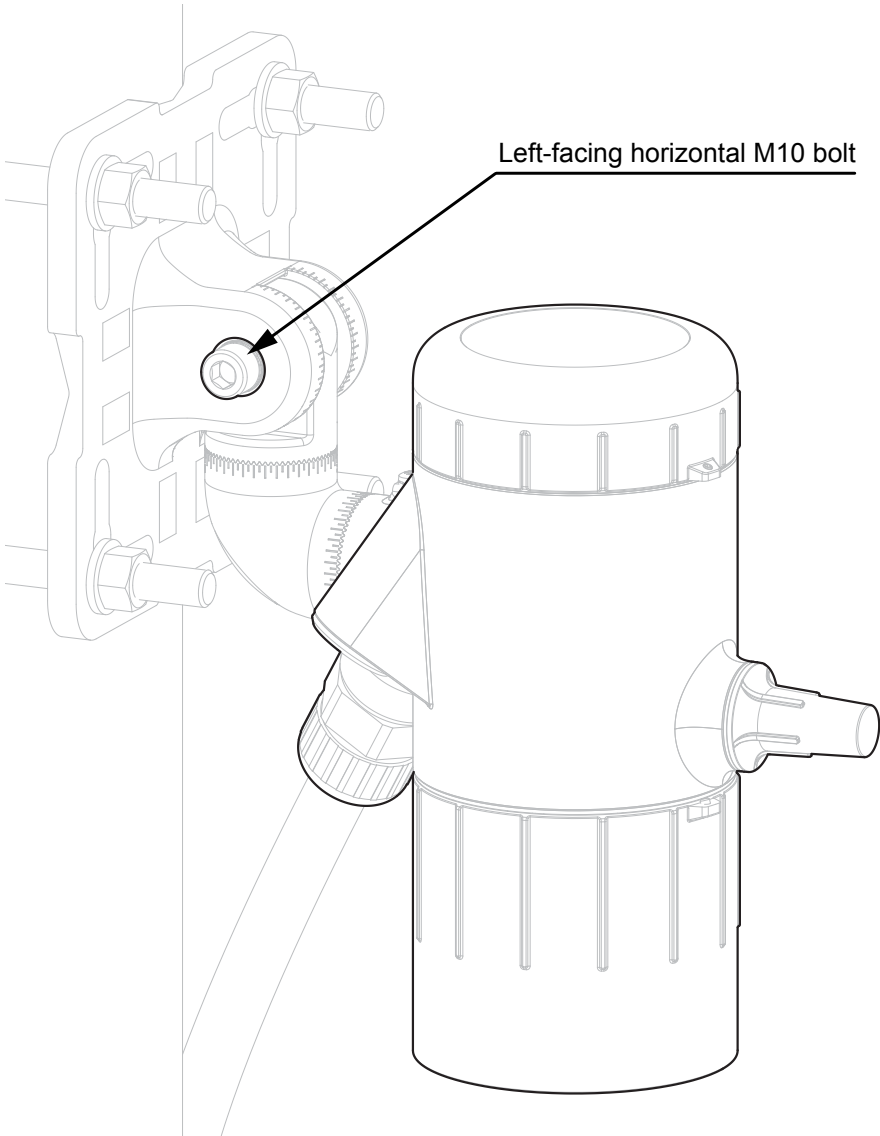

Figure 17. Set the vertical position of Detector to 0°

5.10 Connect Wires to PCB Terminals

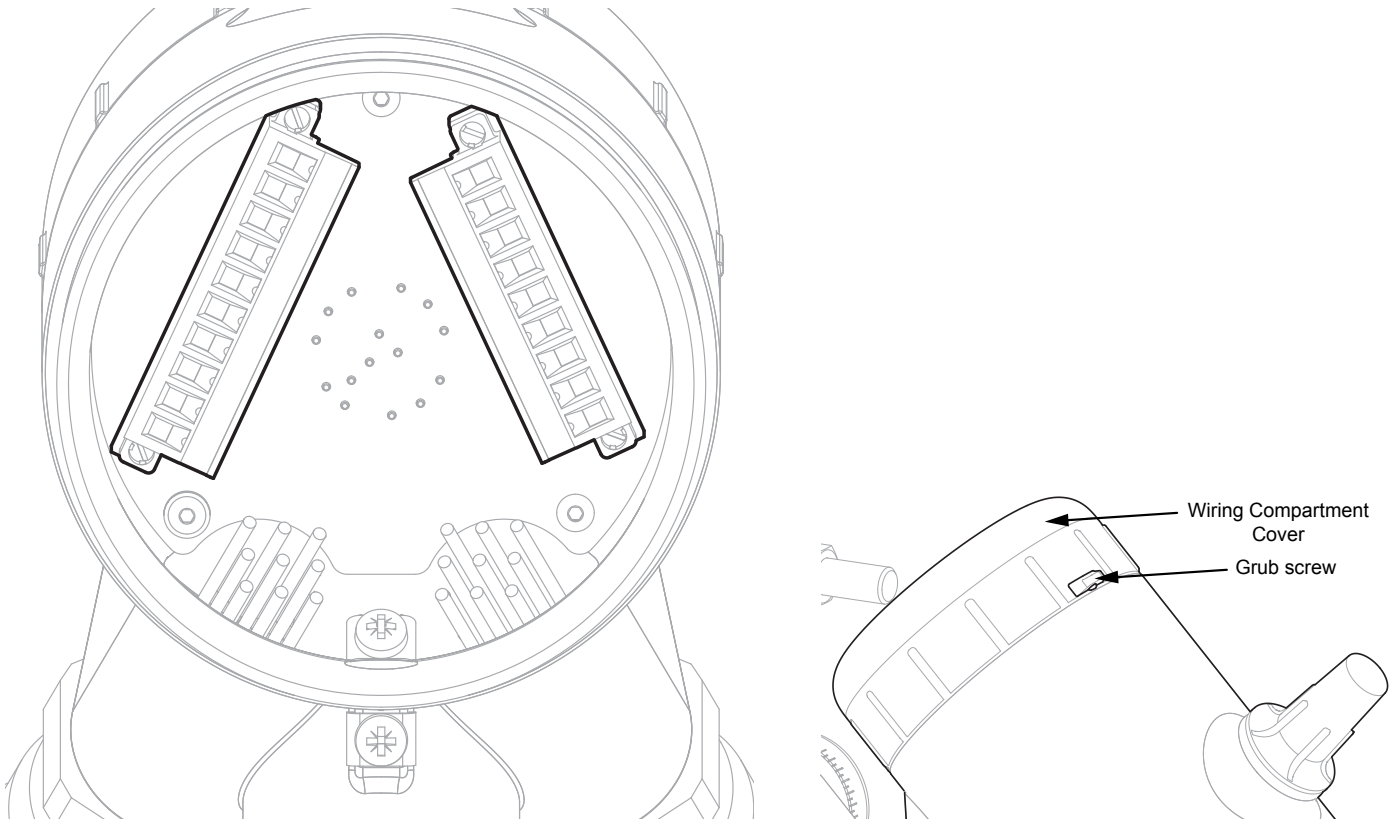

Figure 18. PCB Terminals

CAUTION

Remove power from Searchzone Sonik before performing any electrical installation or maintenance.

CAUTION

The equipment features pluggable connectors that are mechanically locked into position. These are not accessible by the user during normal operation.

1. Loosen the grub screw.
2. Unscrew the Searchzone Sonik wiring compartment cover.
3. Unscrew and remove the pluggable connectors.
4. Connect wires as per local procedures. The connectors are clearly identified. Refer to the diagrams and tables in the *Electrical Installation* section of this manual for information on wiring.
5. Ensure that the O-rings on the detector body and in the end cap are properly fitted and not damaged.
6. Ensure that the threads of the wiring compartment cover are clean of dust and lubricated with a suitable anti-seize compound.
7. Screw on the wiring compartment cover.
8. Tighten the grub screw to a final torque of 1.1 Nm (0.81 lb-ft)
9. Ensure the horizontal M10 bolts are loosened by 2-3 turns.
10. Use the graduated adjustment and angle scale to aim the Detector to the required position.
11. **IMPORTANT:** First, tighten the left-facing horizontal M10 bolt to a final torque of 30 Nm (22 lb-ft).
12. **IMPORTANT:** Second, tighten the right-facing horizontal M10 bolt to a final torque of 30 Nm (22 lb-ft).
13. Fit the sunshade in place. Refer to section 5.11 *Sunshade Installation* for instructions.

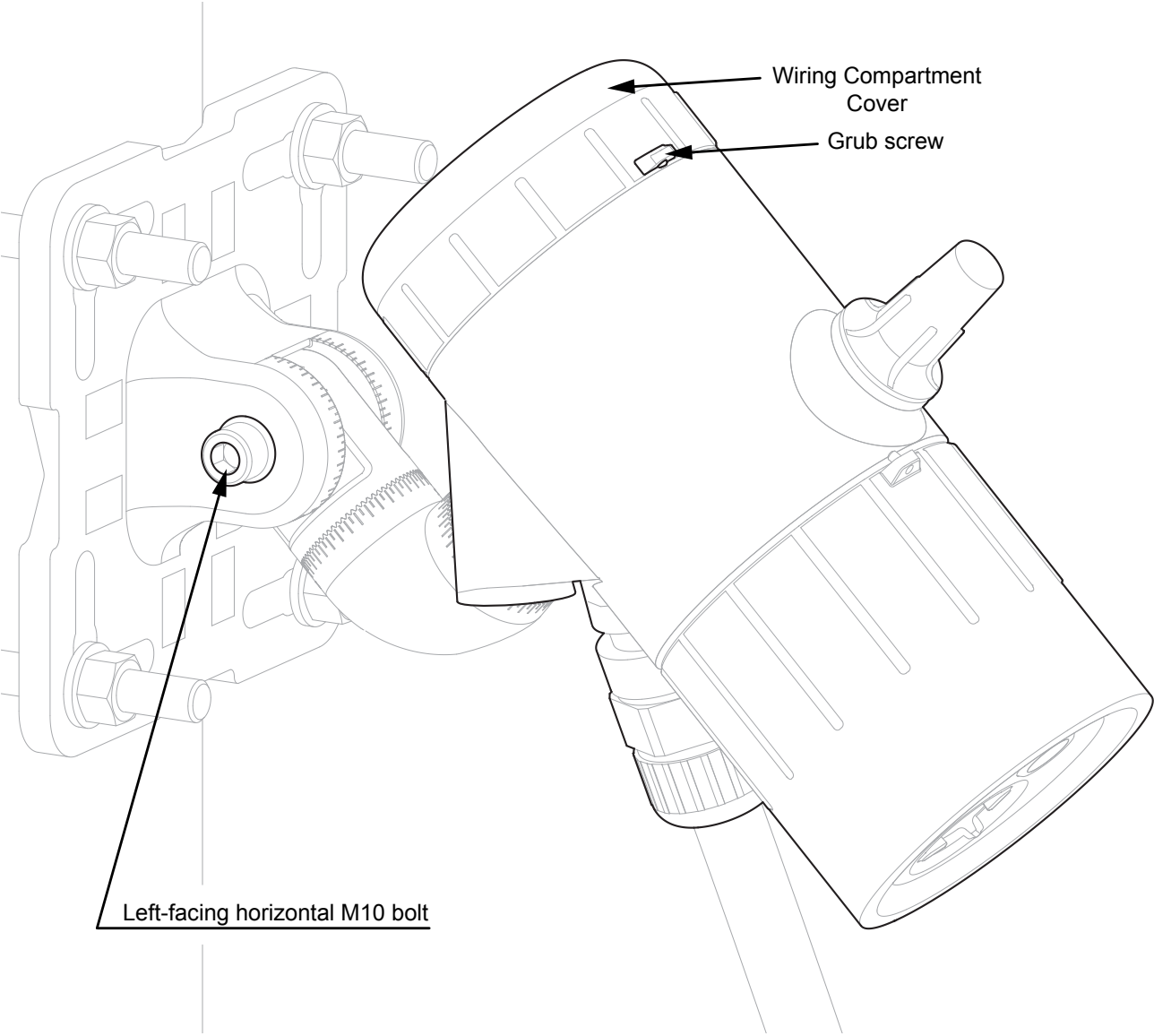

Figure 19. Example position of 45°

5.11 Sunshade Installation

1. Unscrew the antenna cover from the top of the detector.
2. Fit the standard (supplied) or stainless steel sunshade (optional) onto Searchzone Sonik.
3. Ensure the O-ring around the antenna is not damaged and is properly fitted.
4. Screw the antenna cover back onto the antenna.
5. Tighten the antenna cover to a final torque of 5 Nm (7 lb-ft).

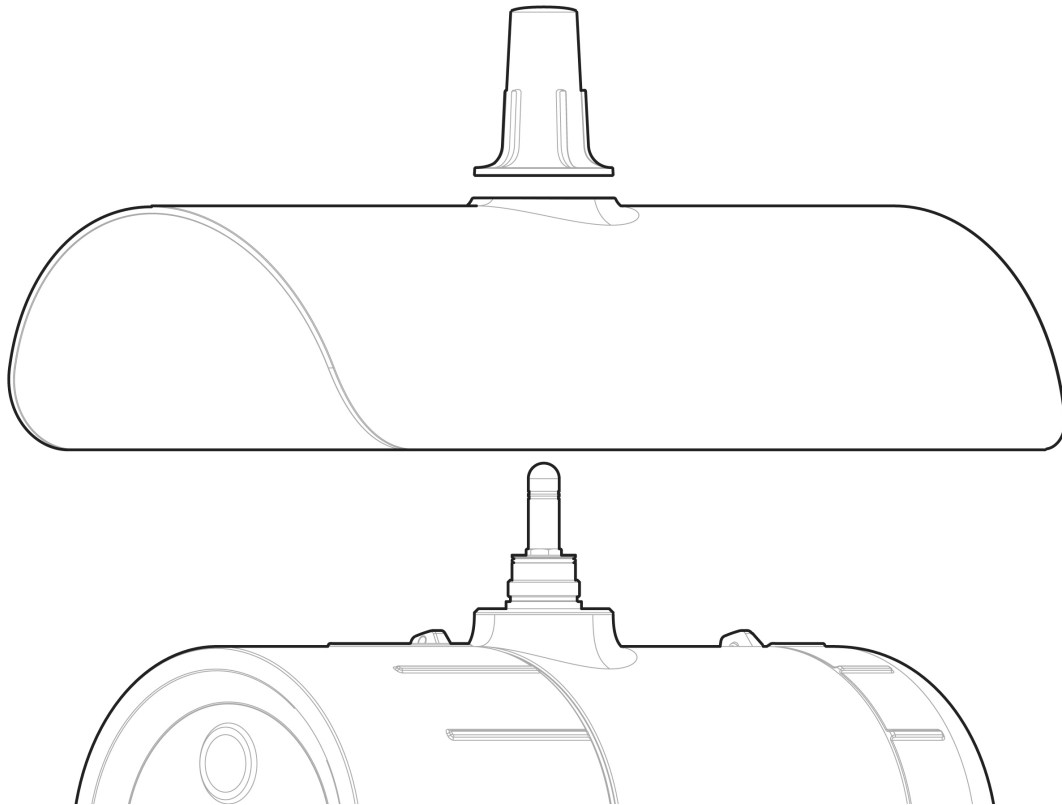

Figure 20. Sunshade and antenna cover

6 Electrical Installation

CAUTION

Remove power from the Searchzone Sonik before performing any electrical installation or maintenance.

6.1 Power Supply Requirements

The Searchzone Sonik detector requires a voltage supply of 18 - 32 Vdc (nominal 24 Vdc). Power consumption is 4 W maximum when the internal heater is not active, i.e. for ambient temperatures above -30°C. At lower ambient temperature the internal heater is active and power consumption may reach up to 15 W.

Ensure that the minimum required supply voltage 18 VDC is present at the detector, taking into account the voltage drop due to cable resistance.

Note

Make allowance for the insertion loss resistance.

The maximum loop resistance in the field cable is calculated as follows:

$$R_{loop} = \frac{V_{controller} - V_{detector\ min}}{(P_{max} / V_{detector\ min})}$$

As an example, $V_{detector\ min} = 18\text{ V}$; $P_{max} = 4\text{ W}$ or 15 W (dependent on environmental conditions) $V_{controller}$ will depend upon the connected power supply or control system. Consult the manual of that equipment for this information.

CAUTION

The detector 24 V power supply and 4-20 mA current loop power supply must be of an isolating type (galvanic isolation from mains, providing basic insulation) but does not need to be a Class II (SELV) power supply.

CAUTION

If mains voltage is connected to more than one relay, all relays must be connected to the same phase of the mains network. Using different phases is not allowed.

6.1.1 Internal Battery Cell

A primary cell featuring an expected operating life of 10 years is fitted internally. This is not accessible and replacement must only be conducted by an authorized service centre.

6.2 4-20 mA Current Loop

The Detector provides a 4-20 mA current loop with HART Communication which can be user configured as a Sink, Source (3-Wire) or Isolated (4-Wire) electrical interface, based on installation requirements.

Depending on configuration, the 4-20 mA current loop output can provide:

- discrete indication of operating modes (Normal operation, Pre-alarm, Alarm) and special states (Fault, Warning, Inhibit, Over-range)
- proportional output to ultrasound pressure level (dB SPL) and a discrete indication of special states (Fault, Warning, Inhibit, Over-range).

The Searchzone Sonik features HART communications to provide access to the detector from a control system or hand-held device for the purpose of configuration and to provide status and diagnostic information.

The total load resistance for the 4-20 mA current loop shall be less than 600 Ω , including the resistance of the 4-20 mA cable and input impedance of the equipment to be connected. To ensure reliable HART communications, the minimum loop resistance is 250 Ω . If HART communications is not required, the minimum loop resistance is 100 Ω .

If the 4-20 mA current loop is not used, a jumper must be connected between 4-20 mA+ (terminal 5) and 24V DC+ (terminal 8) and a load resistor must be connected between 4-20 mA- (terminal 6) and 0V DC (terminal 9). It is recommended to use a 470 Ohm, 1/4 W resistor (250 to 400 Ω if HART is required). With the 4-20mA current loop configured this way the HART facility can still be used with a HART hand held unit using terminals 20 and 21 inside the wiring compartment.

CAUTION

The maximum permissible mA loop voltage is 32 VDC and the maximum current is 22 mA.

6.3 Relays

The Searchzone Sonik detector features 3 SPDT relay outputs for alarm and fault indication. Relay 1 is for alarm level 1, relay 2 is for alarm level 2, and relay 3 indicates faults. The fault relay is normally energized and when energized indicates proper operation (no faults present).

In the event of power failure or fault, the COM-NO connection will open (the fault relay may be user configured as normally de-energized.)

6.4 Connections / Wiring Diagram

Note

24 V pins number 7 & 8 and 0 V pins number 9 & 10 are internally linked.

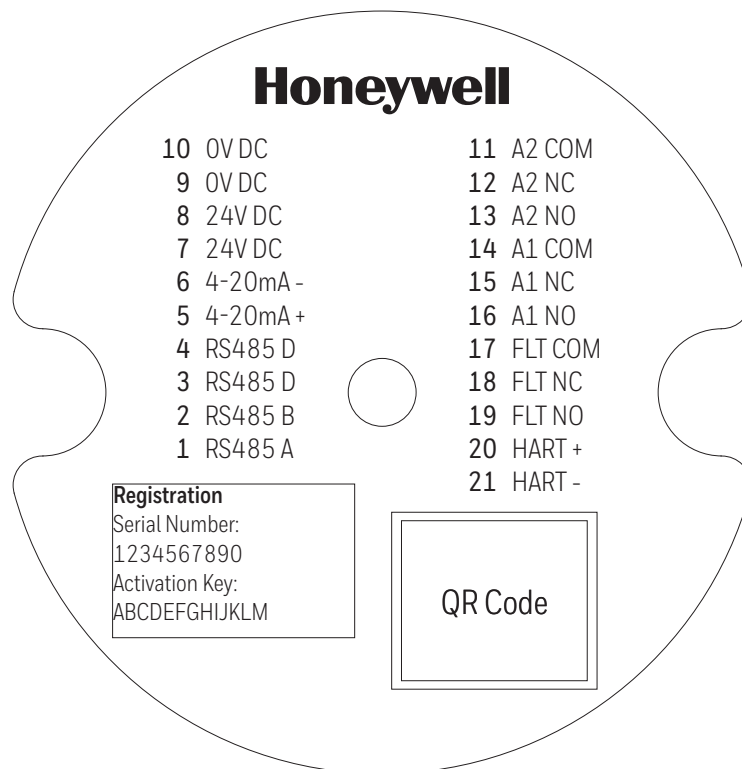

Figure 21. Terminal Connector Label

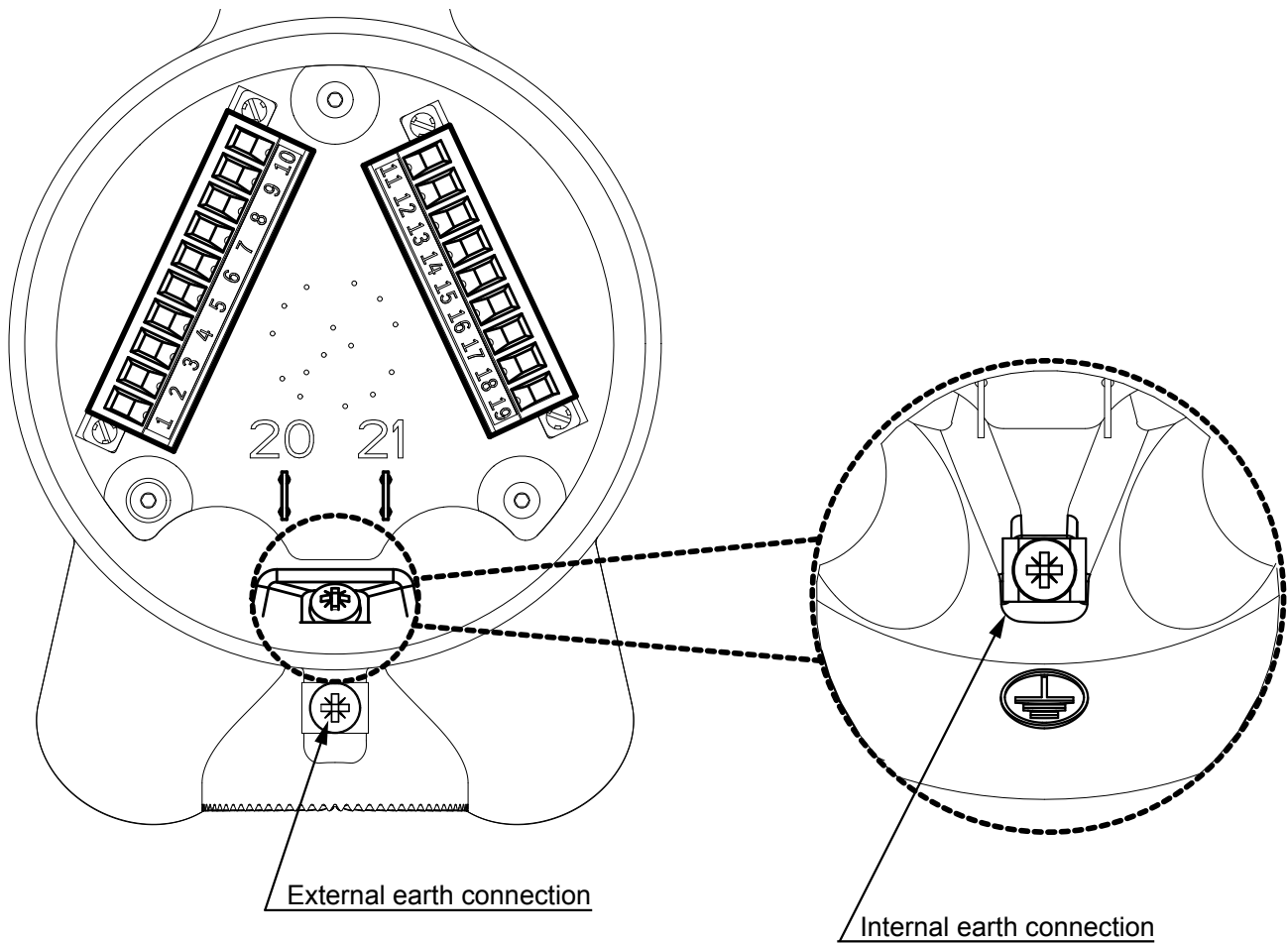

Figure 22. Terminal Wiring Compartment

6.4.1 Terminal Wiring Description

Number	Marking	Description
1	RS485 A	RS-485 A (positive)
2	RS485 B	RS-485 B (negative)
3	RS485 D	RS-485 D (cable shielding)
4	RS485 D	RS-485 D (cable shielding)
5	4-20mA+	mA signal +
6	4-20mA-	mA signal -
7	24V DC	Input power +
8	24V DC	Input power +
9	0V DC	Input power 0V
10	0V DC	Input power 0V

Number	Marking	Description
11	Alarm 2 COM	Alarm Relay 2 COM contact
12	Alarm 2 NC	Alarm Relay 2 NC contact
13	Alarm 2 NO	Alarm Relay 2 NO contact
14	Alarm 1 COM	Alarm Relay 1 COM contact
15	Alarm 1 NC	Alarm Relay 1 NC contact
16	Alarm 1 NO	Alarm Relay 1 NO contact
17	Fault COM	Fault Relay COM contact
18	Fault NC	Fault Relay NC contact
19	Fault NO	Fault Relay NO contact
20	HART+	HART hand-held temporary connection (positive)
21	HART-	HART hand-held temporary connection (negative)

Unused conductors must be suitably terminated. Wiring must be in accordance with local, national and company regulations. Exposed or bare conductors must be avoided.

CAUTION

The maximum permissible mA loop voltage is 32 VDC and the maximum current is 22 mA.

Note

Searchzone Sonik is protected against accidental reversed polarity in wiring.

6.4.2 Searchzone Sonik Connection for mA loop Configuration as Current Source

CAUTION

Ensure that jumper wires are installed applicable for the selected mA current loop configuration.

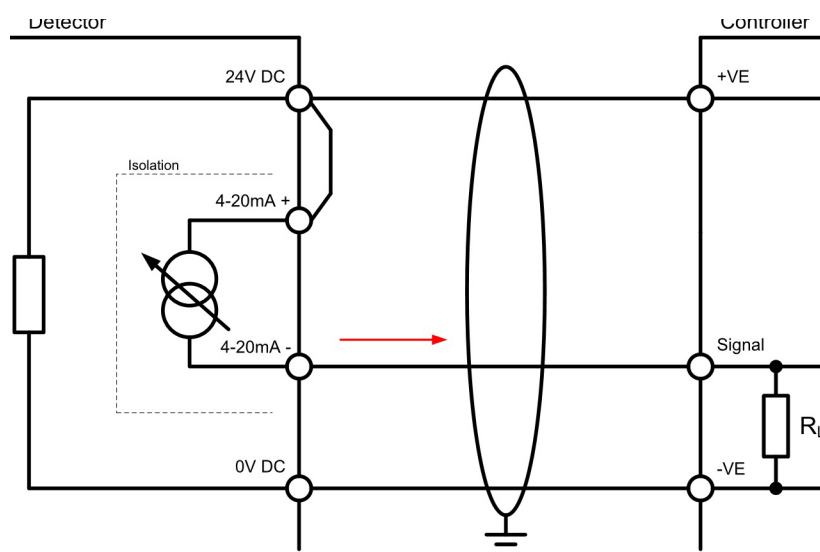

Figure 23. mA loop configuration as current source

6.4.3 Searchzone Sonik Connection for mA Loop Configuration as Current Sink

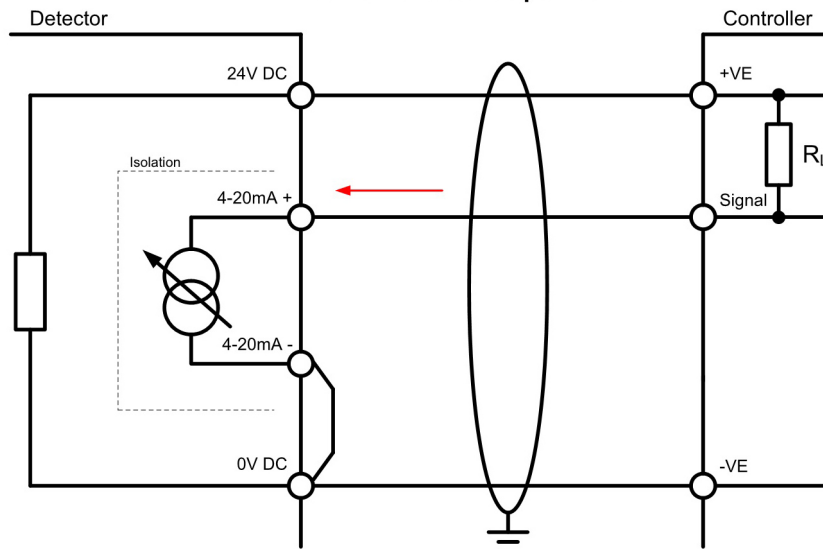

Figure 24. mA loop configuration as current sink

6.4.4 Searchzone Sonik Connection for mA Loop Configuration as Isolated Output

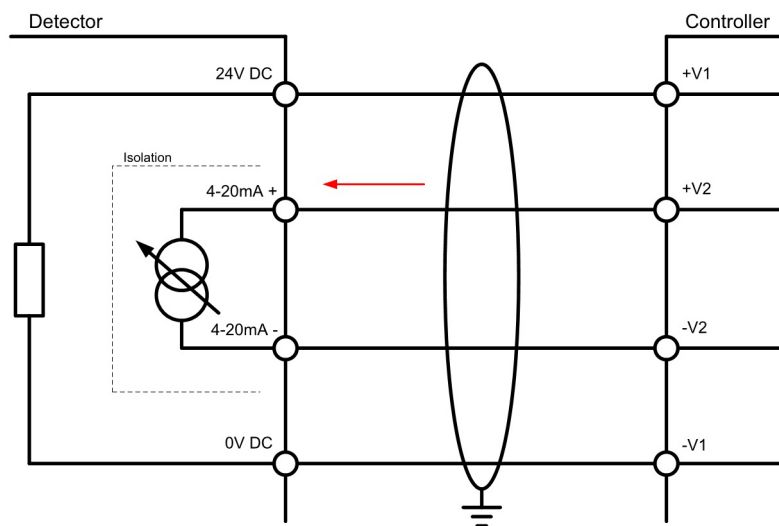

Figure 25. mA loop configuration as isolated output

6.5 Cabling Recommendations

The cable used must be appropriate for the hazardous area classification and must meet local, national and company regulations. The use of industrial grade, screened field cable is recommended.

An example may be a 3-core copper cable with screen (minimum 90% coverage) and suitable mechanical protection (e.g. steel wire armour) to suit an M25 or 3/4" NPT gland entry or conduit, suitable when mA loop and Modbus are used while relay outputs are not utilized.

The allowable conductor size for the terminals is 0.25 – 2.5 mm² (24 - 12 AWG). The Searchzone Sonik terminals will accept only wire sizes (solid-core or stranded) in this range. The temperature rating of the conductors and cable glands should be greater than 80°C. The terminals should be torqued between 0.5 Nm to 0.6 Nm (0.368-0.442 lb.ft).

Ensure that the cable gland is installed correctly and fully tightened. All unused cable/conduit entries must be sealed with a suitable certified blanking plug. Use appropriate and certified cable glands, adapters and/or cable fittings to meet local standards.

6.6 Earthing Recommendations

CAUTION

Any earthing regime employed must avoid earth loops.

The following information is provided to assist with proper earthing of the Searchzone Sonik:

- The Searchzone Sonik has both INTERNAL and EXTERNAL earth points provided (see *Electrical Connections*). This is to facilitate connection of the detector to protective earth.

The INTERNAL earth point is marked with ground symbol in circle  It shall be used for the equipment grounding connection. Internal earth must be at least equal in mm² to the incoming power conductors.

The EXTERNAL earth point is marked with ground symbol without circle  It provides a supplementary bonding connection, which provides facility for connection of field wiring conductors of at least 4mm².

- Field cable screens should be connected to instrument earth at the control room. The other end of the field cable screen should be suitably terminated or isolated. It should not be connected to internal earth point.

6.7 Modbus

Refer to the *Communications* section of this manual for more information on Modbus.

7 Commissioning and Configuration

7.1 First Time Switch On

7.1.1 Pre-power Check

1. Check that the working environment temperature is within the range given in the *Specifications* section of this manual.
2. Check that the Searchzone Sonik detector is mounted correctly and secured in its position. Refer to the *Mechanical Installation* and *Electrical Installation* sections of this manual for more information.
3. Check that the Searchzone Sonik unit is wired correctly. Refer to the *Electrical Installation* section of this manual for more information.

7.2 Operating Function Verification

Check that the Searchzone Sonik detector safety outputs are working properly.

Check that the Searchzone Sonik detector is positioned correctly so as to cover the risk being monitored.

Perform a functional test where appropriate.

7.3 Communication

NOTE

The prerequisite to commissioning using Bluetooth is to have the Searchzone Sonik Mobile App installed to a suitably-approved mobile device and that the user be fully registered to the Honeywell User Management Server (UMS).

7.3.1 Bluetooth®

The Searchzone Sonik detector features a Bluetooth interface that allows non-intrusive connection using a mobile device running the Searchzone Sonik App. The Bluetooth interface is accessed by the mobile device that supports Bluetooth. Refer to the *Mobile App* section of this manual for more information on Bluetooth communication link.

The Searchzone Sonik detector supports Bluetooth point-to-point mode of operation. While there is a connection between the Searchzone Sonik and a mobile device, the detector cannot be scanned or accessed by another mobile device.

If there is no active Bluetooth communication for 10 minutes, the Searchzone Sonik detector will terminate the Bluetooth connection automatically.

The communication range will vary depending on the field situation and installation location of Searchzone Sonik. Optimal range will be achieved when line-of-sight between the Searchzone Sonik detector and the mobile device is achieved.

7.4 Settings and Configuration

The Searchzone Sonik Mobile App is the primary tool for configuring the detector. The configurable settings are as follows:

- Detector ID
- Operation mode
- Algorithm mode
- Inhibit level
- Alarm set point
- Warning level
- Fault level
- Over-range level
- Alarm 1 level
- Alarm 2 level
- Alarm delay
- Proof test interval
- Relay 1, Relay 2, Relay 3
- LED mode
- LED intensity
- Inhibit timeout period
- Set access PIN

Refer to the *Mobile App* section of this manual for more instructions and guidance on installation, commissioning and maintenance.

NOTE

When used with a Touchpoint Pro controller, the positive and negative suppression values must be set correctly otherwise the controller will report a detector fault. Similarly, when used with a Touchpoint Plus controller, the upper and lower deadband values must be set up.

7.5 Delay Time

A delay time is used to minimize the possibility nuisance alarms and/or when immediate response is not required.

The delay time setting should be assessed with regards to the following:

- Searchzone Sonik proximity to monitored object/area or to the source of ultrasonic noise
- The gas type being monitored and the potential severity of a resultant leak
- Existing site protocols and local regulations

The Searchzone Sonik raises two types of alarm:

1) Alarm 1 – suspected alarm activated instantaneously after the measured sound pressure level exceeds the alarm threshold, and is maintained above the Alarm 1 level. At this point, the delay time is applied. If Alarm 1 is still active after the delay time has passed, Alarm 2 is activated.

2) Alarm 2 – confirms Alarm 1. Following activation of Alarm 1, the delay timer starts. If an alarm signal is still present after this time then Alarm 2 is activated.

The delay time is set by user within range from 1 to 600 seconds. Refer to the *Mobile App* section of this manual for more instructions.

7.6 Background Noise Rejection

Use the Searchzone Sonik Mobile App to select between Standard and Focus background noise rejection algorithms. Refer to the *Mobile App* section of this manual for more instructions.

7.7 Performance Verification

Note

Be aware of other ultrasonic gas leak detectors that may be within range before performing any performance verification. To minimize the risk of nuisance alarms, inhibit those detectors where appropriate.

Testing Using Air Cylinder

Use a small canister of compressed air, operated in the vicinity (maximum 5 m of the Searchzone Sonik detector) to test the operation of the detector.

WARNING

Manipulation of compressed gas cylinders is potentially hazardous and should only be performed by trained personnel.

Ensure safety measures are taken in the workplace.

Ensure compliance to local regulations and laws.

8 Operation

8.1 Operation

This chapter describes the operation of Searchzone Sonik in different states (Normal, Alarm, Fault, Periodic Test).

8.2 Status Signalling

Searchzone Sonik utilizes several outputs to indicate its status, namely the high visibility indicator, the mA Loop, relays and digital communication interfaces (Bluetooth, HART and Modbus). The following sections describe the instrument behaviour.

8.2.1 Visual Status Indicator

NOTE:

The visual status indicator is not considered a safety output. Its behaviour is configurable and may indicate different states than other outputs.

Searchzone Sonik is equipped with a high visibility LED status indicator the function of which is to visually indicate the status of the instrument. See the following table for behaviour configuration information:

Operation without Bluetooth	Colour	Flashing	Setting
Fault	Yellow	Yes	Default
Inhibit	Yellow	No	Default
Warning	Yellow	Yes	Default
Normal	Green	No	Default
Normal	Green	Yes	Optional
Normal	None	No	Optional
Alarm	Red	Yes	Default
Over-range	Red	Yes	Default

Operation with Bluetooth	Colour	Flashing	Setting
Fault	Yellow	Yes	Default
Inhibit	Yellow	No	Default
Warning	Yellow	Yes	Default
Normal	Blue	No	Default
Normal	Blue	Yes	Optional
Alarm	Red	Yes	Default
Over-range	Red	Yes	Default
Connecting	Blue	Yes	Default
Connected	Blue	No	Default
Warning	Blue alternating	No	Default

8.2.2 mA Loop Status

The Searchzone Sonik is equipped with a 4-20 mA loop output which can operate in source or sink mode. Source and sink modes are configured by wiring. For more information see the wiring diagram in *Electrical Installation* section. This output is a safety-related output and is compatible for use in SIL 2 applications. Normal operation and alarm conditions are indicated between 4 to 20 mA, depending on configuration.

The mA Loop offers two modes of operations:

- 1) Proportional to the detected sound pressure level.
- 2) Discrete, where the output will switch between distinct levels, based on detector status.

Fault and Inhibit indications are signalled with values lower than 4 mA, Over-range indications are signalled with value higher than 20 mA. Output levels of the 4-20 mA loop are configurable,

See the following table for output levels:

Mode	Default Value (mA)		Min Value (mA)	Max Value (mA)
	Discrete Mode	Proportional Mode		
Fault	1		0	3.6
Inhibit	2		1	3.6
Warning	3		1	4
Normal	4	Proportional to sound pressure level	4	20
Pre-alarm	16	Not available	4	20
Alarm	20	Not available	4	20
Over-range	21		20	22

8.2.3 Relay Signalling

The Searchzone Sonik is equipped with three independent relays, designated for Fault, Alarm1 and Alarm2. These relays are safety-related outputs and are compatible for use in SIL1 applications. The Fault relay is used for indication of various fault conditions; the Alarm1 and Alarm2 relays are used to indicate alarm conditions. All the relays are configurable, giving an option of Normally Energised / De-energised and latching / non-latching of events.

CAUTION

Fault relay will be triggered when user performs Inhibit operation.

8.3 Normal Operation

During normal operation, the 4-20 mA output represents 0 -100% sound pressure level range, depending on the selected mode and the SPL level.

The output is:

- 1) Linear within the range of SPL in Proportional mode
- 2) 4 mA in Discrete mode

Analog outputs lower than 4 and higher than 20 mA represent diagnostic information. The fault relay in this mode is normally energized and the visual indicator is lit steady green.

8.4 Operation During Fault

If Fault is indicated the visual indicator starts to flash in yellow, the fault relay is de-energized and 4-20 mA loop is set to 1 mA.

NOTE:

HART communication requires >1 mA current output to support transmission. If the fault level is configured to be below 1 mA, HART communications will cease.

8.5 Operation During Alarm

Searchzone Sonik features three levels of alarm. Pre-Alarm, Alarm and Overload.

8.5.1 Pre-alarm

During Pre-Alarm, the Alarm1 relay is energized/de-energized depending on its configuration. The 4-20 mA loop is set to 16 mA in Discrete mode. It is proportional to the sound pressure level (SPL) in Proportional mode. The visual indicator flashes red.

8.5.2 Alarm

During Alarm, the Alarm2 relay is energized/de-energized depending on its configuration. The 4-20 mA loop is set to 20 mA in Discrete mode. It is proportional to SPL in Proportional mode. The visual indicator flashes red.

8.5.3 Overload

Searchzone Sonik indicates Overload when an exceptionally high SPL is detected (>140 dB). During Overload, the Fault relay is additionally energized/de-energized depending on its configuration. The 4-20 mA loop is set to >20 mA in both Discrete mode and Proportional mode. The visual indicator flashes red.

Searchzone Sonik indicates Fault for thirty seconds after the Overload condition is no longer detected.

Note

Searchzone Sonik logs 10 minutes of recording for each of the last 5 verified alarms. The 10 minutes are divided into 5 minutes before and 5 minutes after the alarm.

9 Mobile App

The Searchzone Sonik App is an Android-based mobile application that is used to configure and commission Searchzone Sonik detectors.

CAUTION

The Searchzone Sonik App has been designed and tested to run on the Ecom Smart-EX 01 mobile phone. Operation on other mobile devices is possible.

9.1 General User Access

There are three methods of accessing detector from the mobile device:

- 1) Normal access. The user is registered and associated with the company account to which the detector is registered, and has Internet access.
- 2) Off-line access. The user is registered and associated with the company account to which the detector is registered, but has no Internet access at the time of connection. The user must periodically log in to the App when Internet access is available, to maintain the security certificate.
- 3) Ad-hoc access. The user is registered, but not with the company account associated with the detector. The user must have access to the detector Serial Number and Activation Key in order to access the detector. This access is only available when no Internet connection is available, or the device's Internet access has been disabled. This type of access is not intended for normal day-to-day use.

Access should be granted only to suitably trained and accredited engineers.

A user of the system is able to:

- 1) Commission (set-up) the Searchzone Sonik – the App connects to the detector using Bluetooth and takes the user to the commissioning work flow.
- 2) Create and manage other users. The App allows user to access the user management features after successful authentication and login.

9.2 Terminology

Admin User	The user who initially creates a Company account and registers a detector to that account is created as an Admin user for the company. An Admin user can invite further individuals as users, using the App. The new users will become Admin users once they have been validated.
Visitor	A user who creates an account but does not register a detector remains a Visitor.

9.3 Communications

User creation requires the Sonik Searchzone App to be installed on a suitable Android device featuring Bluetooth and an Internet connection.

9.3.1 Company Account Management

The Initial Admin User is considered the first user who is registered that will go on to create a Company group. Once done, they will then be able to create and invite subsequent users to that Company group.

In order to create this initial Admin user, they will need to register at least one Searchzone Sonik detector with their account. The account creation will not be completed until this is done.

Note

It is not possible for an existing user to be added to a new Company Group. Please use the Add User function in the User Management section of the App to add additional users to the Company group, using a new email address.

Note

Once the user is registered on ums.honeywell.com, they can use the same credentials (and Company Group) to access other Honeywell Industrial Safety products.

9.3.2 Creating a New Company Account

Use the following method to create a new Company Account and Administrator. To add a new user to an existing account, use the method described in section 9.3.2.3 Adding Further Users to Company Account

To create a new Company Account, you will be required to provide an email address, which will become your unique user name for the account.

Enter the following data:

- First name
- Last name
- Email address
- Password

The password must contain:

- at least 8 characters
- at least 1 upper case character (A-Z)
- at least 1 lower case character (a-z)
- at least 1 digit (0-9)
- at least 1 special character

The password must NOT contain:

- the account name itself
- a consecutive string of three or more repeated characters (e.g., AAA1111)
- the names (or abbreviations) of months or the weekdays (e.g., JAN, MON, etc.)

After you have entered all the required information, tap on '**CREATE ACCOUNT**' button. This will trigger the Verification Email to be sent to the email address that was given for that user.

A verification email will be sent to the given email address within 15 minutes. You must respond to the email within 24 hours before it expires.

Open this email and click on the verification link on any suitable device (i.e., PC, tablet or smartphone). You will then be directed to a web page where you will need to re-enter the password chosen on the Account Creation page. Click or tap on OK.

Return to the Searchzone Sonik App. The UMS will automatically complete the account verification process.

Note

The verification link will expire after 24 hours. After this has passed, repeat the steps in section 9.3.2 and a new verification link will be sent to the nominated email address.

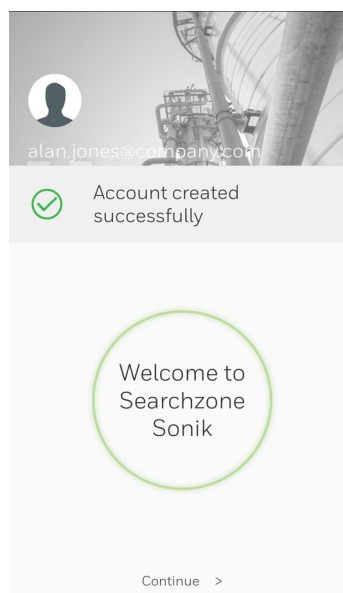
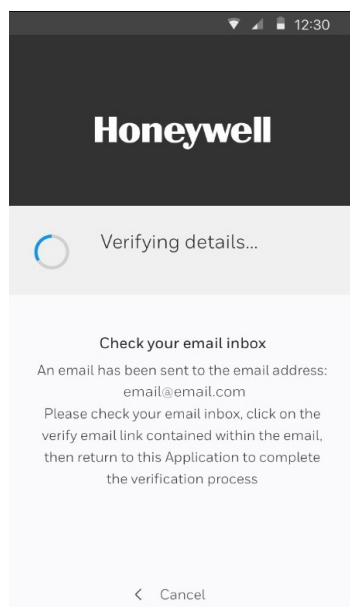

9.3.2.1 First Detector Registration

If the Company Account being created is the Initial Admin User for a company group, you must register at least one Searchzone Sonik detector in order to complete the User Registration. Refer to section 9.4 *Detector Registration* on how to do this.

9.3.2.2 Security Certificates

Each user requires a valid certificate to be loaded on each mobile device used to access Searchzone Sonik detectors. The certificate is valid for 365 days. A new certificate is automatically downloaded each time you log into the App as long as there is a connection to the Internet.

Once the certificate is downloaded, you will then be prompted to register a detector to fully enable the features of the Searchzone Sonik App.

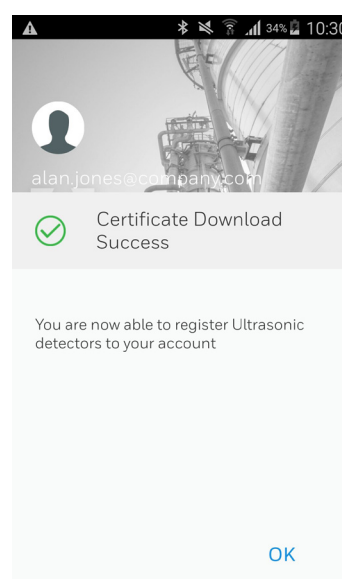

9.3.2.3 Adding Further Users to Company Account

When authenticated, new users will have the same administrative rights as the Initial User and will be able to access all detectors already registered, in addition to being able to register further detectors.

Advise the new user that they will receive an authentication email, and ensure that they are able to respond to the email within 24 hours. Agree an initial password.

Navigate to the **'SETTINGS'** menu, go to **'User Management'** screen in the Searchzone Sonik App and tap on the '+' button in the top right-hand corner.

Enter the user's email address, First Name, Last Name and the initial password. Tap on the **'ADD USER'** button. The user will receive a confirmation email, normally within 15 minutes.

They will need to click on the link in that e-mail and they be directed to a web page where you will need to re-enter the password chosen on the Account Creation page. Tap on **'OK'**.

That user will then be able to log in to their account.

Repeat this process to add further users.

Refer to section 9.11 *User Management* for more information.

9.3.2.4 Completing the Account Setup

Once you have successfully set up the account, you and the users that you have added will be able to access all of the detectors that you have registered against it.

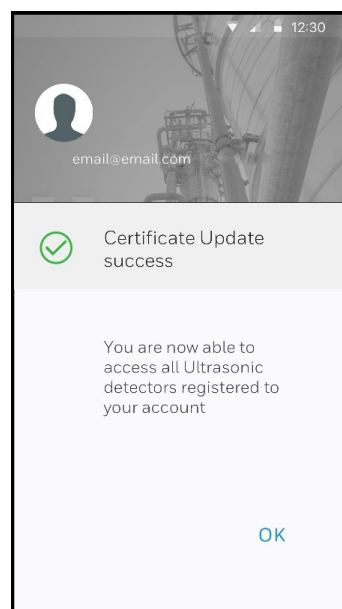

9.3.2.5 Logging In to Searchzone Sonik App (with Internet Connection)

Connect to the Internet and log in to the App. Open the App on your mobile device and enter the email address and password for your account.

Your certificate will be automatically updated and a confirmation message shown.

You will be presented with the Home Page with three key options:

Search for detectors (DETECTORS)

View and manage reports (REPORTS)

View and manage app settings (SETTINGS)

Navigate to the required function by simply tapping on it.

9.3.2.6 Logging In to Searchzone Sonik App (without Internet Connection)

If your mobile device is not connected to the Internet, you can still log in to the Searchzone Sonik App and access registered detectors. You must have previously carried out at least one normal login (see section 9.3.2.5), with an Internet connection.

Your security certificate will remain valid for 365 days, allowing you to login off-line. When this period expires you will need to log in again with an Internet connection to update your security certificate. You will not be able to access settings or detectors until the security certificate has been updated.

9.3.2.7 Forgotten Password

Go to the login screen.

Tap on **'Forgot your password?'**

Enter the email address provided during the creation of the account and tap on **'Continue'**.

Check your email inbox for the password reset link and instructions.

Follow the instructions and reset your password.

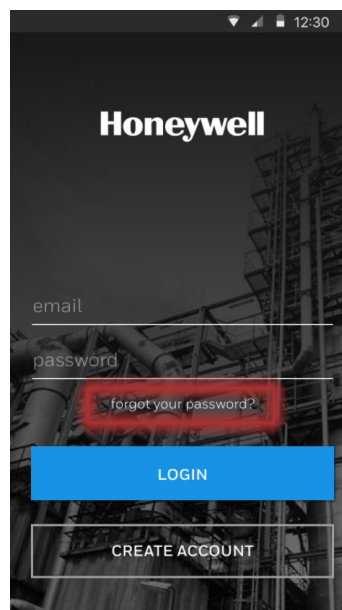

9.3.2.8 Changing Password

Go to the main menu and tap on the avatar icon to access account details.

Alternatively, choose Settings / User Management / Account Details.

Tap on **'CHANGE PASSWORD'**.

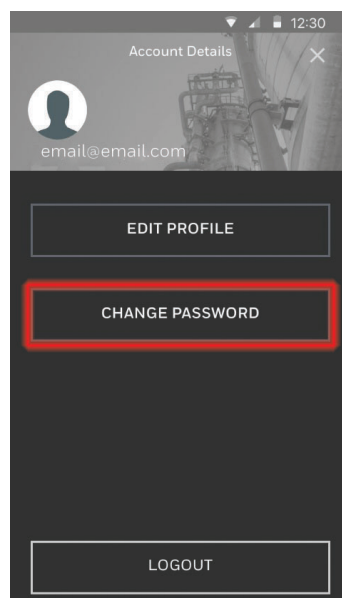

9.3.2.9 Detector Registration

To register a detector:

- Ensure that you have an Internet connection.
- Ensure that you have the serial number of the detector you wish to register together with either the Activation Key or the activation QR code.

The Activation Key and QR code may be obtained from:

- The Registration Sheet supplied with detector
- Site records
- The label inside detector wiring compartment
- By contacting your Honeywell Customer Support

Tap on the preferred method for entering this information and then either enter the Serial Number and Activation Key manually or scan the QR code as applicable.

Your security certificate will then be updated and you will now be able to access this detector.

To register further detectors, tap on 'SETTINGS' from the home screen and tap on 'Detector Registrations'. Tap on the '+' icon in the top right-hand-corner of the screen and repeat the process above.

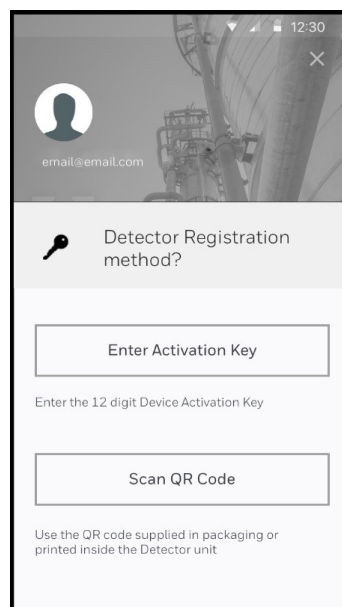

Note

If the registration of the Searchzone Sonik detector fails, it may be for several reasons:

- 1) the detector is already registered to another company
- 2) the detector does not exist
- 3) the Activation Key is already in use
- 4) the Activation Key and/or Serial Number is not valid

9.4 Connecting to Detectors

9.4.1 How to Connect to a Searchzone Sonik Detector

This section assumes that the Searchzone Sonik detector has been already registered to the company account. If it has not, then read section 9.4.2 *Making an Ad-Hoc Connection to the Detector*.

After logging into the Searchzone Sonik mobile App, you can use Bluetooth to search for Searchzone Sonik detectors that are in range. If Bluetooth is not switched on, the App will prompt the user to switch it on.

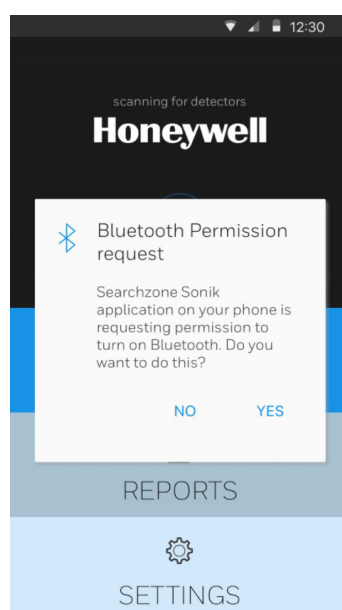

The App lists only Searchzone Sonik detectors positioned within range. Other Bluetooth devices are ignored.

Tap on '**DETECTORS**'.

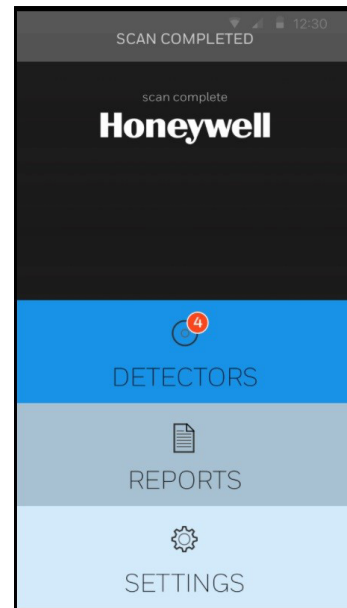

To sort the list of detectors, tap on the MENU icon and then tap on '**Detector List**'.

Select one of the detectors in the list to establish a connection to it.

You can sort the detector list based on:

- Detector status

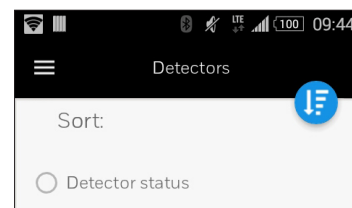

The selected detector's high visibility status indicator will be flashing blue, indicating that it is establishing a connection to the Searchzone Sonik mobile App.

Tap on the '**CONFIRM DETECTOR**' button to complete the connection process.

Note

If the connection process is not completed within 30 seconds, the connection to the detector will be terminated. Restart the connection process and try again.

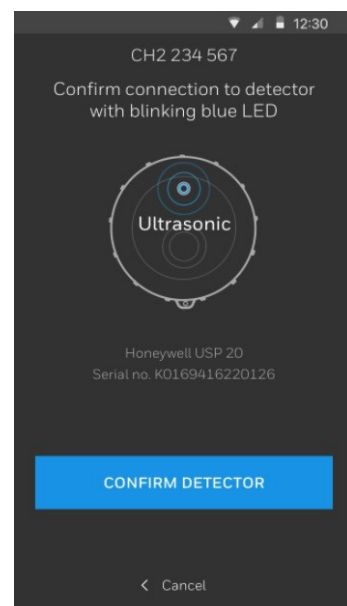

After successfully connecting to the detector, you will be prompted to enter a 4-digit access PIN .

CAUTION

If logging in for the first time, you must set a new PIN by clicking on **'set new access PIN'**.

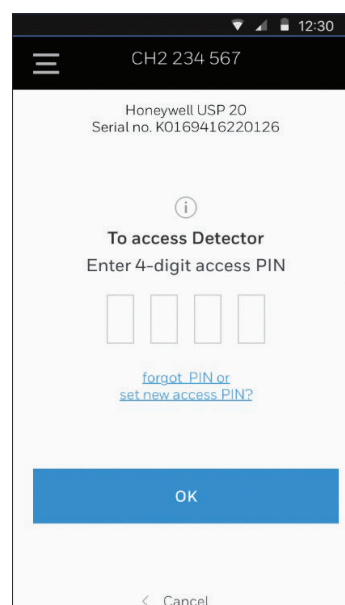

9.4.2 Making an Ad Hoc Connection to the Detector

If normal connection to a detector is not possible, a temporary ad-hoc connection can be established as follows:

1. Obtain the Activation Key and Serial Number of the detector. The Activation Key may be obtained from:
 - The registration sheet supplied with that detector
 - Site records
 - The label inside detector wiring compartment
 - By contacting your Honeywell Customer Support
2. Ensure the mobile device is NOT connected to the Internet. Disconnect it from Wi-Fi and from the mobile data. The easiest way to do this is to place the mobile device into Airplane Mode.
3. Switch on Bluetooth on the mobile device.
4. Log in to the Searchzone Sonik mobile App.
5. Tap on **'DETECTORS'** to search for Searchzone Sonik detectors in range.
6. Select the desired Searchzone Sonik detector.
7. Scan the QR code as displayed on the registration sheet or on the internal label. Alternative, manually enter the Serial Number and Activation Key.
8. Enter the 4-digit PIN set for that detector.

When using an ad hoc connection, you can connect to a Searchzone Sonik detector only within the given session. You can change the PIN during this ad hoc session. After disconnecting from the detector, future connection will require re-entering of the Activation Key and Serial Number, or re-scanning the QR code.

9.5 Detector Overview

9.5.1 Detector Status

Once connected to the detector, the Searchzone Sonik mobile App will display the detector's status and current ultrasonic sound readings (in decibels).

The colour scheme of the Searchzone Sonik app will mirror that of the detector status as shown, in the following table:

Detector State	App Colour Scheme	Flashing Status
No power	Black	None
Normal	Green	Solid
Warning	Amber & Green	Solid (toggle between amber & green)
Fault	Amber & Black	Solid
Inhibit	Amber	Solid
Warning	Green & Amber	Blinking (toggle between green & amber)
Alarm	Red	Blinking
Over-range	Red	Blinking
Bluetooth pairing / connecting	Blue	Blinking
Bluetooth paired / connected	Blue	Solid
Normal (Bluetooth connected)	Blue	Solid
Warning (Bluetooth connected)	Blue & Amber	Solid (toggle between amber & blue)
Fault (Bluetooth connected)	Amber & Black	Solid

The '**Overview**' tab for the selected detector provides information on the current state of the detector together with the current reading. Some examples of screens that may be seen in the 'Overview' tab are shown below.

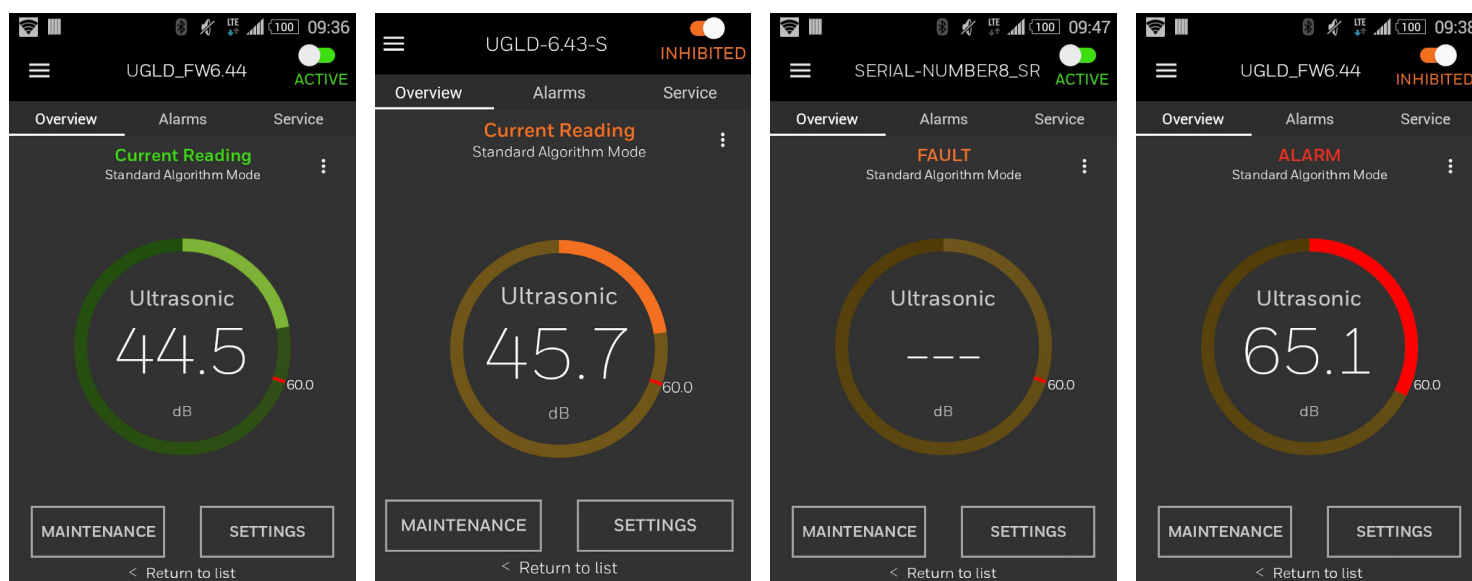

9.5.2 Detector Inhibit

The detector can be placed in an inhibit state for maintenance purposes. This will have the effect of suppressing the alarms, the current loop will be forced to the level that has been set for inhibit and the visual indicator will light yellow.

To do so, swipe the control in the top-right of the screen to the right.



A message will be displayed to inform you that this will suppress alarms. Tap OK to continue or Cancel to return to the present condition.

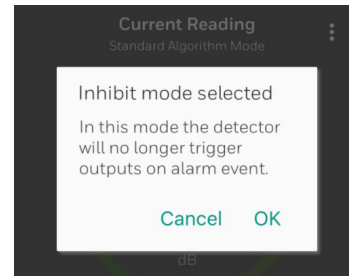

CAUTION

Fault relay will be triggered when user performs Inhibit operation.

To return to Active mode, swipe the control in the top-right of the screen to the left and acknowledge the message.

Note

The Searchzone Sonik detector will remain in Inhibit mode. It is possible to set a time out so that the detector returns to Active mode after a preset amount of time. Refer to section 9.9 *Detector Settings* for more information.

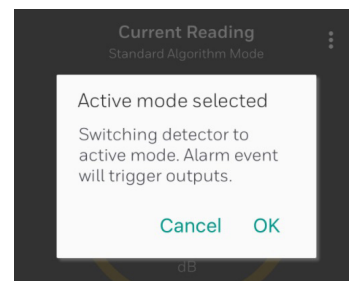

CAUTION

The default inhibit timeout is set 0 and the detector will remain in inhibit unless end user manually clears the inhibit condition. Changing the inhibit timeout settings (to, for example, 10 minutes) and saving the changes will NOT affect the current session. The change in inhibit timeout will be made in next session when end user puts the detector into inhibit.

9.6 Detector Alarm History

Connect to the detector and navigate to the **'Alarms'** tab on the reading screen by swiping left on the screen.

Browse through the alarm history of the detector.

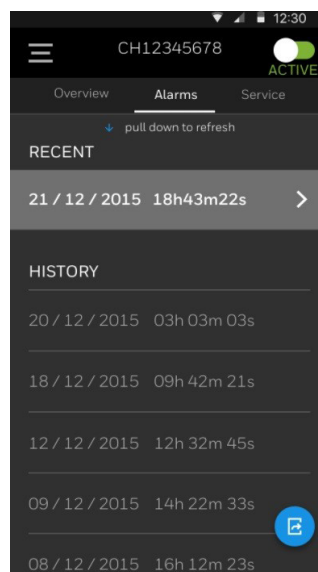

Select an alarm record. You can see the graphical representation of the alarm readings.

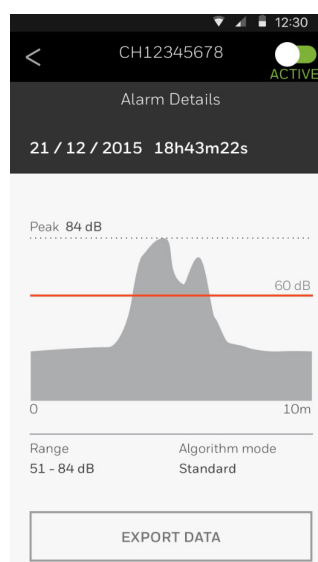

Tap on the **'EXPORT DATA'** button to create a file on the mobile device containing this data.

The exported data should be interpreted as follows:

SampleCount	Total number of samples
StartTime	Timestamp of least recent sample in buffer
AlarmTime	Timestamp of alarm event
EndTime	Timestamp of most recent sample in buffer
TimeDelay	Alarm delay in seconds
AlarmSetPoint	User configured set point in dB SPL
BandThresholds	Level threshold for each frequency band in dB SPL
CounterThreshold	Evaluation counter threshold
AlgorithmMode	Algorithm mode selected at time of alarm event
BandEvalStart	First band to consider for evaluation
BandEvalCount	Number of bands to consider for evaluation
StddevThreshold	Standard deviation threshold for each frequency band in dB SPL

9.7 Detector Maintenance

The Searchzone Sonik App features a range of tools to aid the correct maintenance of the Searchzone Sonik detector. After connecting to the detector via Bluetooth, you can perform maintenance tasks, e.g., setting the maintenance flag, testing the output current loop, setting relays, checking the function of the visual status indicator settings and running other diagnostic tests.

Note

In order to adjust any of the detector settings the detector must be placed into inhibit mode. The fault relay will change state and the mA current loop will drop to the inhibit level. Make sure that any effect on connected equipment is full understood.

Connect to the detector and navigate to the main menu.

Select **'Maintenance'**.

You can access the following:

- Event log
- Set maintenance flag
- Output test
- Diagnostics

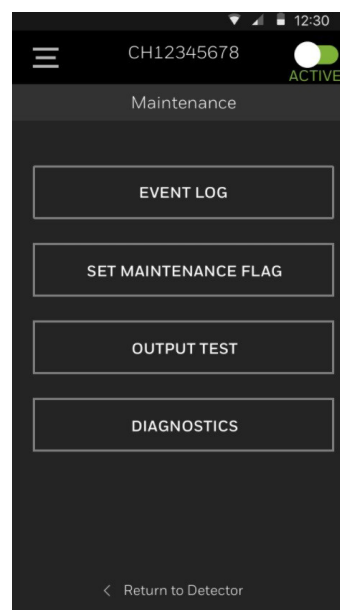

Note

Unlike many ultrasonic gas leak detectors, Searchzone Sonik does not require field calibration. Bump testing is achieved using a cannister of compressed air.

9.7.1 Event Log

In the **'Maintenance'** menu, tap on **'Event log'**.

The log will open.

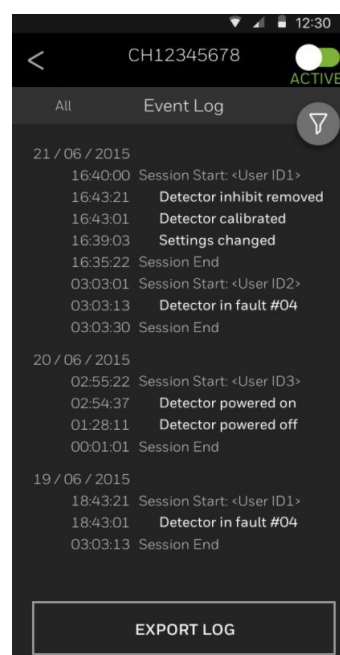

Tap on the **'Filter'** icon to open the options.



Select the filter options as required.

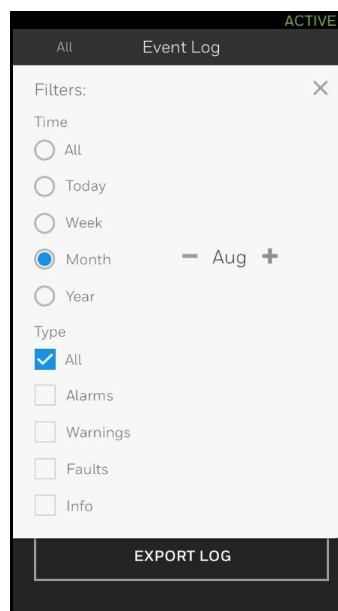

Tap on **'EXPORT LOG'** to export the diagnostic data to a CSV file on the mobile device.

9.7.2 Set Maintenance Flag

It is possible to set a Maintenance Flag on the detector. This allows easy identification of those detectors that have been identified as requiring attention.

The maintenance flag may be set to indicate to other users that maintenance work is being carried out on a detector. When set, a maintenance icon will be set on the detector overview screen which will be visible to other users when they connect to the detector.

The flag is not automatically cleared, and must be cleared by the user who set the flag or by another user.

In the **'Maintenance'** menu, tap on the **'Set maintenance flag'** option.

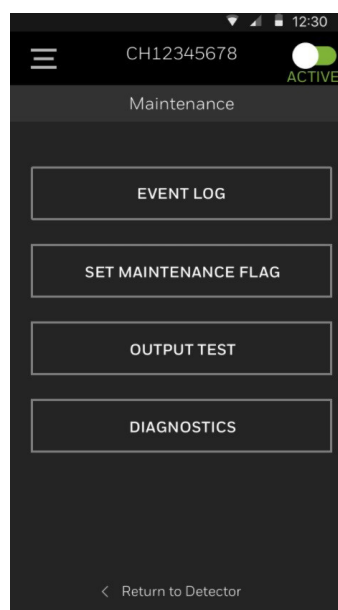

You will be prompted to confirm to set the flag.

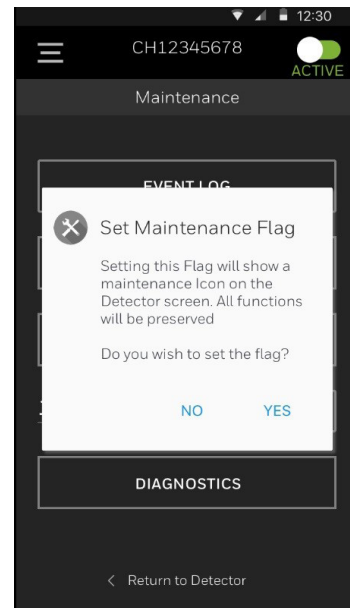

The maintenance icon will be shown on the screen.

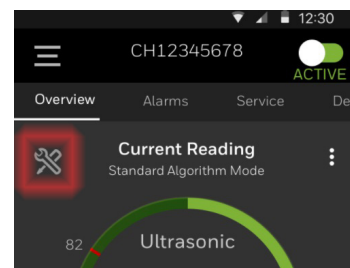

9.7.3 Output Test

Various aspects of the detector outputs can be manipulated and checked for test and verification purposes.

In the **'Maintenance'** menu, tap on the **'Output Test'** option.

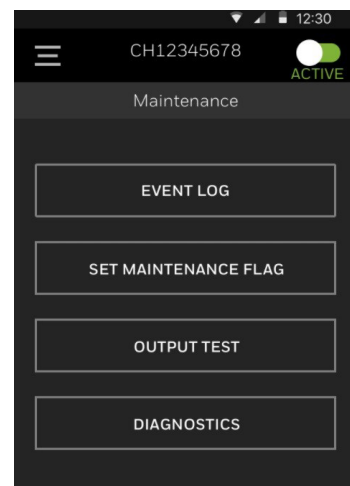

9.7.3.1 Force mA Loop

This feature allows you to temporarily set the mA current output loop to a specific value, which is useful for checking that the connected control system is reporting the expected value.

Set the **'Set Force Loop Value (mA)'** and tap on 'Apply Force Loop' button.

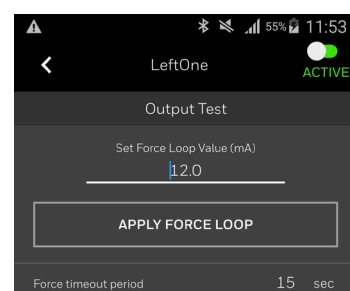

9.7.3.2 Force timeout

On applying a timeout value to 'Force Timeout', the following 3 timeout values will be set on the detector:

1. mA Force Loop Timeout
2. Relay Force Timeout
3. LED Force Timeout

9.7.3.3 Force relay

This feature allows you to set each of the 3 relays to one of three states:

OFF

NORMAL

ON

Select a '**RELAY**' as required and force its state.

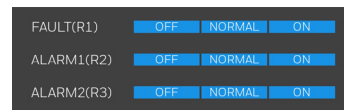

9.7.3.4 Set Visual Indicator

Select a '**LED state**' as required to force the status of the visual indicator of the detector.

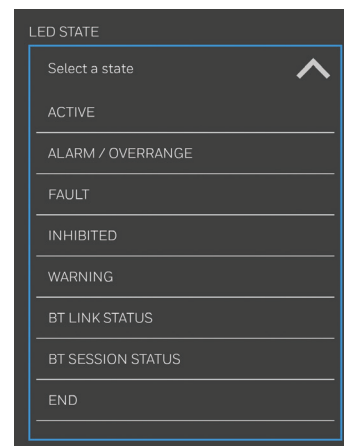

9.7.4 Diagnostics

In the '**Maintenance**' menu, tap on the '**Diagnostics**' option.

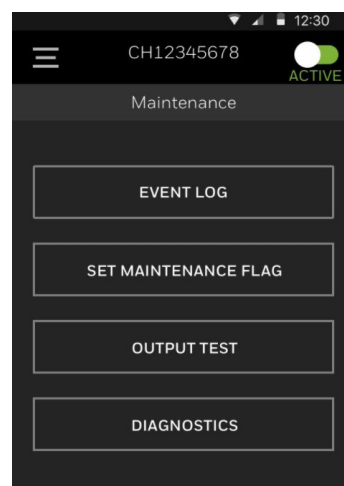

The **'Diagnostics'** menu opens.

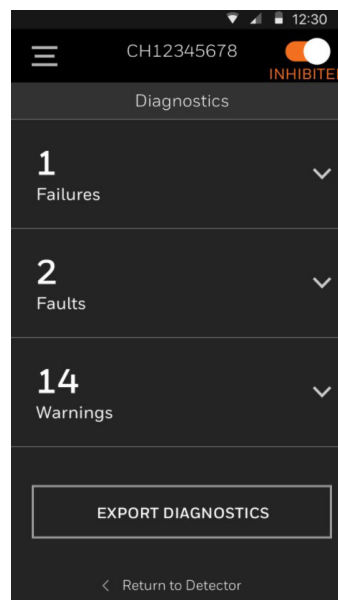

Tap on **'Failures'**, **'Faults'** or **'Warnings'** to show the results of diagnostics.



To export diagnostics data, go to the Diagnostics menu and tap on **'EXPORT DIAGNOSTICS'**.

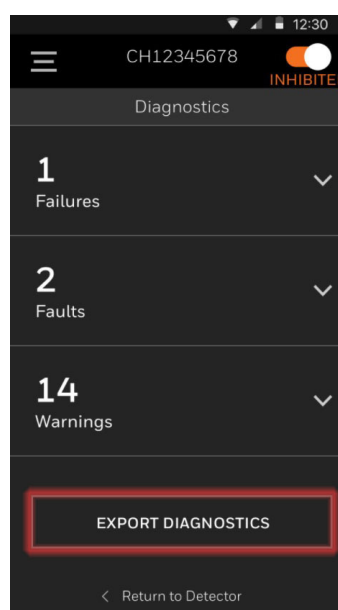

9.8 Detector Settings

You can view all of the detector settings, including firmware details and background levels, with an option to export this data to a CSV file. (The CSV file is saved in the mobile device in location defined in the Application Settings.)

To access the detector settings, tap on the **'SETTINGS'** button from the **Overview** screen. You can also edit some of the detector settings by tapping on the **'Edit'** button.

The following values can be adjusted:

Detector ID	(minimum characters are 4; maximum characters are 26. Supports special characters like !@#\$%^&*()_+{} :;<>?[\],',./-)
Operation mode	(Discrete or Proportional)
Algorithm mode	(Standard or Focused)
Inhibit level	(Default value = 2 mA; Minimum value = 1 mA; Maximum value = 3.6 mA; Step increments of 0.1 mA)
Alarm set point	(40 dB to 120 dB)
Warning level	(Default value = 3 mA; Minimum value = 0 mA; Maximum value = 4.0 mA; Step increments of 0.1 mA)
Alarm 1 level	(4.0 mA to 20.0 mA; step 0.1 mA; default 16.0 mA)
Fault level	(Default value = 1 mA; Minimum value = 0 mA; Maximum value = 3.6 mA; Step increments of 0.1 mA)
Alarm 2 level	(4.0 mA to 20.0 mA; step 0.1 mA; default 20.0 mA)
Over-range level	(Default value = 21 mA; Minimum value = 20 mA; Maximum value = 22 mA; Step increments of 0.1 mA)
Alarm delay	(1 s to 600 s)
Normal level	(4 to 20 mA)
LED mode	(Normal ON; Alerts; All OFF)
LED intensity	(Dim; Low; Medium; High; Bright)
Proof test interval	(1 to 1825)
Alarm Latch	(Enable or Disable)
Loop current mode	(Multidrop or Point-to point)
Hart poll address	(0 to 63)
Fault Relay	(Open/de-energized or 0, closed/energized or 1)
Alarm 1 Relay	(Open/de-energized or 0, closed/energized or 1)
Alarm 2 Relay	(Open/de-energized or 0, closed/energized or 1)
Inhibit timeout period	(60 to 600 seconds; 0 means no timeout)
Set Access Code	(4 digit)

CAUTION

1. The default inhibit timeout is set 0 and the detector will remain in inhibit unless end user manually clears the inhibit condition.
2. Changing the inhibit timeout settings (to, for example, 10 minutes) and saving the changes will NOT affect the current session. The change in inhibit timeout will be made in the next session when end user puts the detector into inhibit.
3. Loop current mode: Multidrop or Point-to-point
4. HART poll address: 0 to 63

After you connect to the detector, navigate to the main menu.

Tap on the **'Settings'** button.

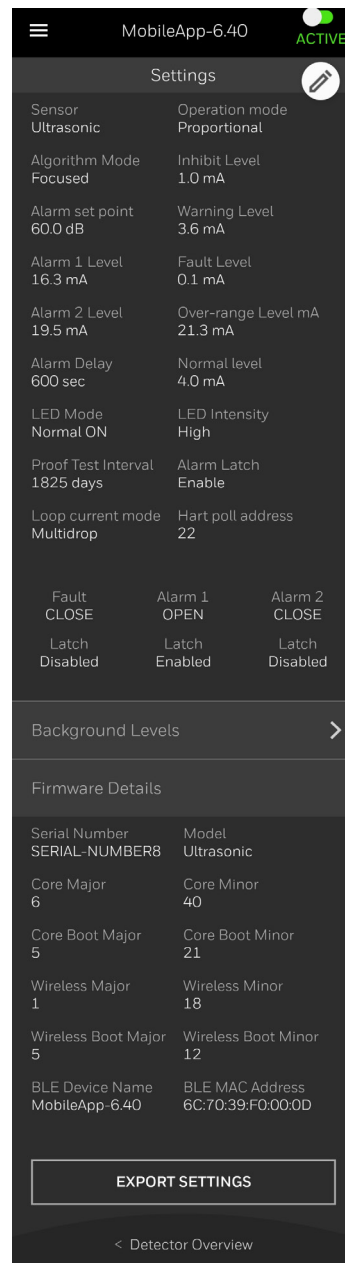

9.8.1 Firmware Version

Tap on **'Firmware Details'** to display the current detector firmware information.

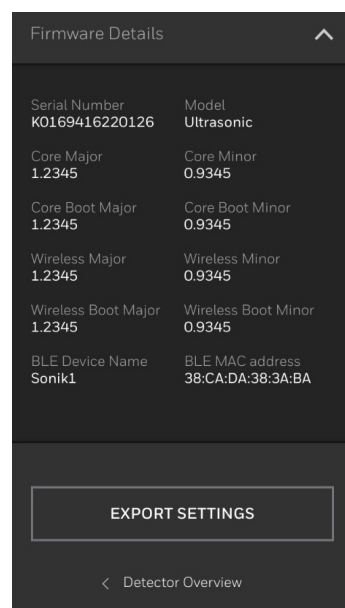

9.8.2 Background Levels

The Searchzone Sonik App allows you to view a historical record of the background ultrasonic noise that has been logged by the connected Searchzone Sonik detector. This is particularly useful when determining suitable alarm levels for that particular situation.

Tap on **'Background Levels'** to display the background noise peaks. An instantaneous reading is taken every 5 minutes to give a broad overview on the site background noise.

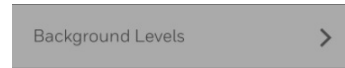

In the **'Background Levels'** you will see a scatter graph of the last month's background levels data.

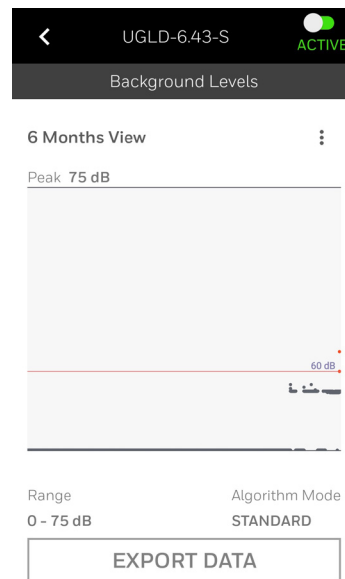

Note

The Background Levels view can be used to validate and check that the current detector settings are suitable.

To change the period tap on the icon shown opposite.



Choose a different period for the data.



9.8.3 Editing Detector Settings

To change the settings, tap on the **'Edit Settings'** icon.



The **'Edit Settings'** page will open.

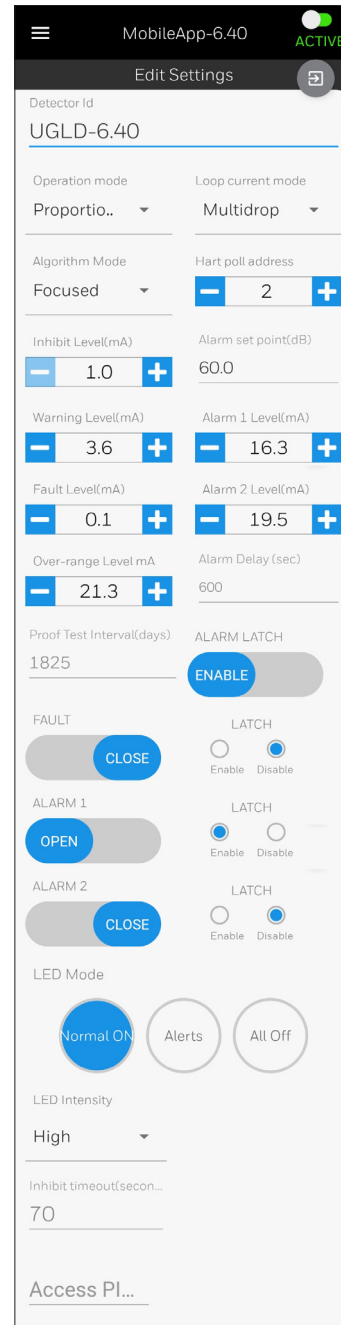

Enter a **'Detector ID'** (such as an equipment tag number), which can contain alpha numeric characters. Should the string entered contain invalid characters, a warning message will be displayed. Check the **'Detector ID'** and make changes where necessary.

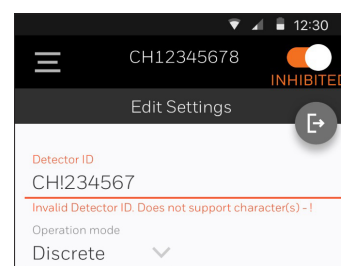

Use 'plus' and 'minus' buttons to adjust values as required. Long press the button for faster setup.

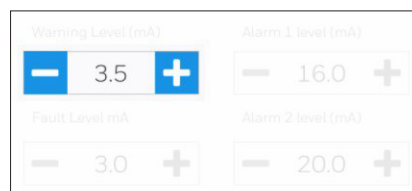

Tap on the 'Operation mode' menu to switch between 'Discrete' or 'Proportional' mode.

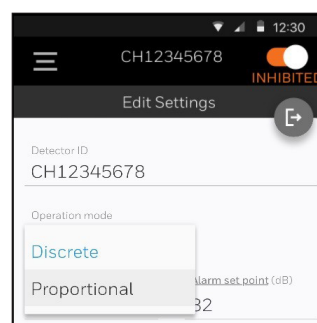

Tap on the 'Algorithm mode' menu to choose 'Standard' or 'Focus' mode.

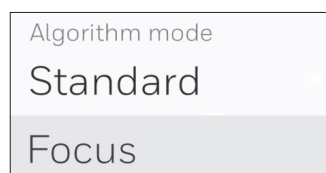

To finish editing at any point, tap on the 'Exit' icon.



You will be prompted to confirm or reject the applied changes.

If you wish to exit **without** applying the changes, tap on **'Yes'**.

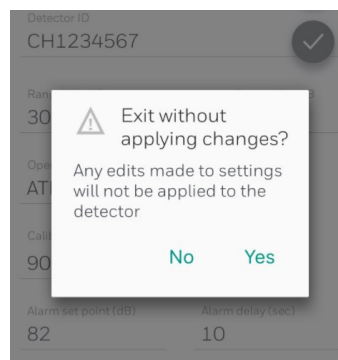

You will be prompted to confirm the applied changes or restore the previous version.

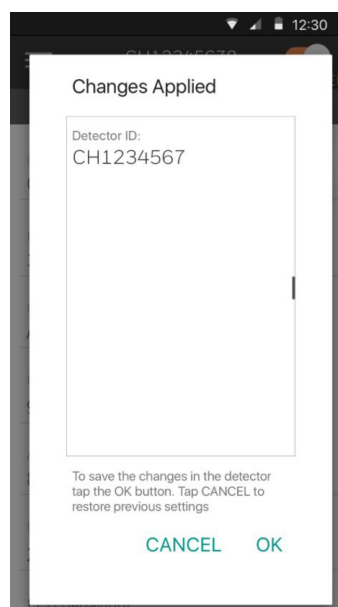

Failure to apply the changes generates a warning message.

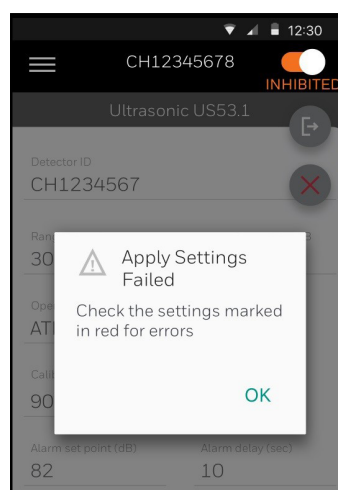

9.9 How to Change Application Settings

The application settings allow you to manage certificates, storage location for reports and default language. It also provides information on the current App software version. Depending on your administrator privileges, you can manage other user's rights.

Navigate to the main menu and tap on the 'Settings' option.

The application settings screen will be shown.

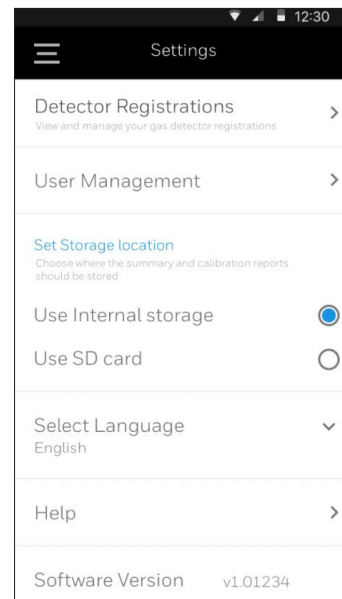

9.9.1 Detector Registrations

Tap on 'Detector Registrations'. A list of all detectors that are registered to your company will be shown as a series of cards. Each card will show the date and time that each detector was registered to your company. To remove a detector from your account, tap on the 'REMOVE' button and confirm.

CAUTION

If the last connection and synchronization with the server was more than **1 year previously**, a caution message will be shown with request to establish an Internet connection and restore detector registration.

If the detector certificate has **expired**, a caution message will be shown with a request to establish an Internet connection to renew certificate and restore detector registration.

If it is not possible to access Internet and the detector certificate has expired, you will not be able to log into the App.

You will receive a pop-up warning 10 days prior to the expiry date.

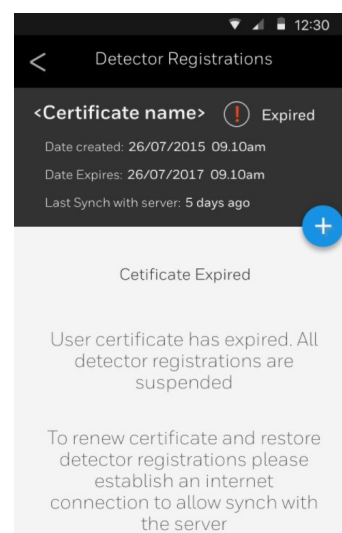
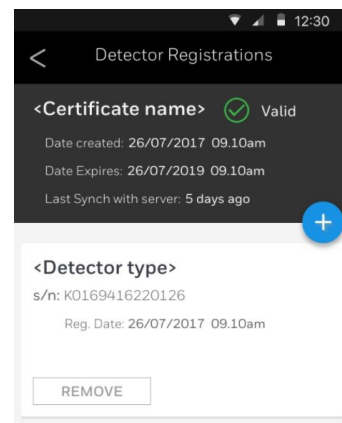

9.10 User Management

In the main menu, tap on **'User Management'** to view and manage user settings.

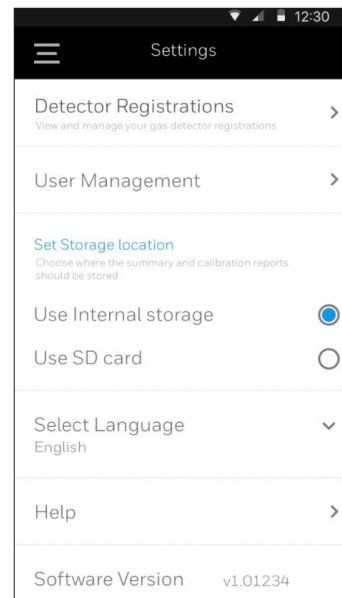

A list of users associated with your account is shown.

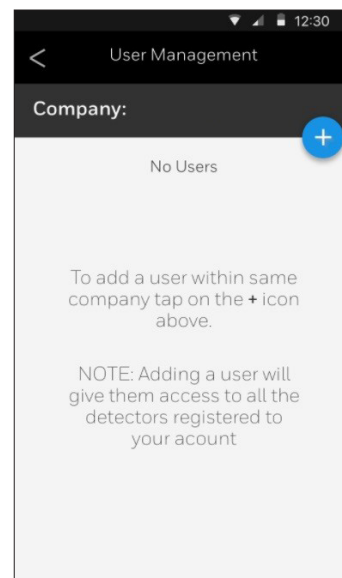
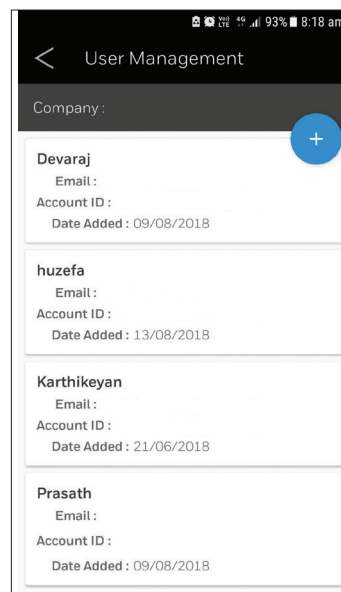

If you wish to add a user within the same company, tap on the **'plus'** icon.



Fill in the new user data. Confirm by tapping on **'ADD USER'** button.

The screenshot shows the 'Add User' form with the following fields:

- Email: john.smith@company.abc
- First Name: John
- Last Name: Smith
- Password: *****
- Confirm Password: *****

A blue button labeled 'ADD USER' is located at the bottom of the form.

Once the new user registration is complete, an email will be sent to the email address specified.

Tap on **'OK'** button.

The screenshot shows the 'Add user complete' dialog with the following details:

- Company:** Acme Inc.
- Add user complete** (with a green checkmark icon)
- User Details**
 - email: john.smith@company.abc
 - Account ID: john.smith@company.abc
 - Date Added: 01/11/2017
- Message: An email has been sent to the above address. To complete the account registration the user will be required to click on the link in the email and enter the password used when creating the account.
- OK** button

If you wish to remove a user, select the user and tap on the **'REMOVE'** button. Confirm by tapping on **'OK'**.

The screenshot shows the 'User Management' screen with the following details:

- Company:** Acme Inc.
- <User name>**
- email: email.address@internet.com
- Account ID: email.address@internet.com
- Date Added: 01/11/2017
- REMOVE** button (highlighted with a red box)

10 Communications

10.1 HART®

CAUTION

Read the section below if HART communications are being used to communicate with Searchzone Sonik.

General

Searchzone Sonik can communicate using the HART protocol, which provides digital communications superimposed on the standard analogue output. More information about the HART protocol can be found at the HART Communication Foundation's website www.fieldcommgroup.org.

HART is a master-slave protocol, i.e. Searchzone Sonik does not continually transmit data but will respond on request.

Searchzone Sonik has a HART Device Description (DD) file, which is available to download from Honeywell Analytics website www.honeywellanalytics.com or the HART Communication Foundation website www.fieldcommgroup.org.

The DD file is written using HART version 7, and is compatible with HART DD Tokenizer versions 6 and 8.

The DD file is supplied in .fm6, .fm8, .hhd and .hdd versions. It is compatible with a wide range of industry standard products.

To use the HART communications, load Searchzone Sonik DD file into a suitable HART host (see manufacturer's instructions).

The secondary master can be a handheld terminal. The detector has been tested with the handheld Emerson field communicator.

Connection

It is best to use a dedicated HART interface point to connect a HART master (primary or secondary).

If such an interface is not available, it is possible to connect to HART signal across a load resistor in the current loop, point-to-point mode. For example, provided there is the minimum resistance of 250 Ω in the 4-20 mA loop, the HART handheld device can be connected across the terminals in the junction box.

CAUTION

If using multi-drop mode, the mA output cannot be used to provide a functional safety rated output signal.

10.1.1 Searchzone Sonik HART Interface

Access Levels and Password Protection

The Searchzone Sonik user interface recognizes three login profiles. Default profile 'Guest' offers limited access rights. The second profile 'Engineer' is available to wider engineering personnel. The third profile 'Honeywell Engineer' is restricted to Honeywell Field Service personnel.

The default 'Guest' profile is read-only and displays information about the current gas leak reading and detector status, including active warnings and faults.

The 'Engineer' profile access is required to test the detector, and to make changes to the default configuration.

The 'Engineer' profile access is password protected (8 digit alphanumeric, case sensitive). To avoid potential compatibility issues between different HART host devices, ensure that a full 8 digit password is used.

The password is factory set to 00000000 (eight zeroes). Instructions to change the password are given below.

NOTE

Some HART handheld devices will retain the previous login until switched off, even if Searchzone Sonik is disconnected. Ensure that 'Engineer' profile access is protected from unauthorized use by logging off when appropriate.

10.2 Menu Structure

The home screen displays current information about Searchzone Sonik.

Home SCREEN	
1 User logged in as	Guest
2 Change login profile	1 Guest 2 Engineer 3 Honeywell Engineer
3 Device Overview	
4 Device Setup	

Selecting Device Setup leads to the further menu options, depending on the access level of the user.

The menu structures are given below. 'xxxx' represents information, '???' represents a user text field.

DEVICE OVERVIEW MENU – GUEST ACCESS LEVEL		
Device Overview	1 Device ID	xxxx
	2 Detector Status	xxxx
	3 Ultrasonic Level	xxxx
	4 PV Loop Current	xxxx
	5 Operation Mode	xxxx
	6 Algorithm Mode	xxxx
	7 Function Test Due	xxxx
	8 Time	xxxx
	9 Date	xxxx

DEVICE SETUP MENU – GUEST ACCESS LEVEL		
Device Setup	1 Diagnostics 2 Event History	1 Internal and Security Events 2 Alarms/Proof Test 3 Service
	1 Diagnostics 2 Event History	1 Active Warnings 2 Active Faults

DEVICE SETUP MENU – ENGINEER ACCESS LEVEL			
Device Setup	1 Operations 2 Diagnostics 3 Event History 4 Settings 5 Account	1 Detector Status xxx 2 Inhibit Detector 3 Output Test 4 Clear Latch	1 Force Timeout xxx 2 Force Loop 3 Set Force Relay 4 Force LEDs 5 Edit Force Timeout
	1 Operations 2 Diagnostics 3 Event History 4 Settings 5 Account	1 Active Warnings 2 Active Faults	

DEVICE SETUP MENU – ENGINEER ACCESS LEVEL			
Device Setup	1 Operations 2 Diagnostics 3 Event History 4 Settings 5 Account	1 Internal and Security Events 2 Alarms/Proof Test 3 Service	1 Latest Log 2 Older Log
Device Setup	1 Operations 2 Diagnostics 3 Event History 4 Settings 5 Account	1 Detector Status xxxx 2 Inhibit Detector 3 Algorithm Mode 4 Alarms 5 mA Loop 6 LED 7 Relay 8 Bluetooth 9 Function Test Period 10 HART 11 Assembly Details	1 Start 2 End
Device Setup	1 Operations 2 Diagnostics 3 Event History 4 Settings 5 Account	1 Detector Status xxxx 2 Inhibit Detector 3 Algorithm Mode 4 Alarms 5 mA Loop 6 LED 7 Relay 8 Bluetooth 9 Function Test Period 10 HART 11 Assembly Details	1 Algorithm Mode xxxx 2 Configure Algorithm Mode
Device Setup	1 Operations 2 Diagnostics 3 Event History 4 Settings 5 Account	1 Detector Status xxxx 2 Inhibit Detector 3 Algorithm Mode 4 Alarms 5 mA Loop 6 LED 7 Relay 8 Bluetooth 9 Function Test Period 10 HART 11 Assembly Details	1 Alarms Set Point xxxx 2 Alarm1 Level xxxx 3 Alarm2 Level xxxx 4 Alarm Delay xxxx 5 Alarm Latch xxxx 6 Configure Alarms xxxx

DEVICE SETUP MENU – ENGINEER ACCESS LEVEL			
Device Setup	1 Operations 2 Diagnostics 3 Event History 4 Settings 5 Account	1 Detector Status xxxx 2 Inhibit Detector 3 Algorithm Mode 4 Alarms 5 mA Loop 6 LED 7 Relay 8 Bluetooth 9 Function Test Period 10 HART 11 Assembly Details	1 Operation Mode xxxx 2 Fault Level xxxx 3 Inhibit Level xxxx 4 Warning Level xxxx 5 Over range Level xxxx 6 Configure mA Loop xxxx
Device Setup	1 Operations 2 Diagnostics 3 Event History 4 Settings 5 Account	1 Detector Status xxxx 2 Inhibit Detector 3 Algorithm Mode 4 Alarms 5 mA Loop 6 LED 7 Relay 8 Bluetooth 9 Function Test Period 10 HART 11 Assembly Details	1 LED Intensity xxxx 2 LED Mode xxxx 3 Configure LED
Device Setup	1 Operations 2 Diagnostics 3 Event History 4 Settings 5 Account	1 Detector Status xxxx 2 Inhibit Detector 3 Algorithm Mode 4 Alarms 5 mA Loop 6 LED 7 Relay 8 Bluetooth 9 Function Test Period 10 HART 11 Assembly Details	1 Fault (R1) xxxx 2 Fault (R1) Latch xxxx 3 Alarm1 (R2) xxxx 4 Alarm1 (R2) Latch xxxx 5 Alarm3 (R3) xxxx 6 Alarm3 (R3) Latch xxxx 7 Change Relay Status
Device Setup	1 Operations 2 Diagnostics 3 Event History 4 Settings 5 Account	1 Detector Status xxxx 2 Inhibit Detector 3 Algorithm Mode 4 Alarms 5 mA Loop 6 LED 7 Relay 8 Bluetooth 9 Function Test Period 10 HART 11 Assembly Details	1 Bluetooth xxxx 2 Address xxxx 3 Detector ID xxxx 4 Adv Interval xxxx 5 Configure Bluetooth

DEVICE SETUP MENU – ENGINEER ACCESS LEVEL			
Device Setup	1 Operations 2 Diagnostics 3 Event History 4 Settings 5 Account	1 Detector Status xxxx 2 Inhibit Detector 3 Algorithm Mode 4 Alarms 5 mA Loop 6 LED 7 Relay 8 Bluetooth 9 Function Test Period 10 HART 11 Assembly Details	1 Function Test Interval xxxx 2 Change Interval
Device Setup	1 Operations 2 Diagnostics 3 Event History 4 Settings 5 Account	1 Detector Status xxxx 2 Inhibit Detector 3 Algorithm Mode 4 Alarms 5 mA Loop 6 LED 7 Relay 8 Bluetooth 9 Function Test Period 10 HART 11 Assembly Details	1 Poll Address xxxx 2 Short Tag xxxx 3 Long Tag xxxx 4 Description xxxx 5 Loop Current Mode xxxx 6 Configure HART 7 HART Parameters
Device Setup	1 Operations 2 Diagnostics 3 Event History 4 Settings 5 Account	1 Detector Status xxxx 2 Inhibit Detector 3 Algorithm Mode 4 Alarms 5 mA Loop 6 LED 7 Relay 8 Bluetooth 9 Function Test Period 10 HART 11 Assembly Details	1 Config Revision xxxx 2 Poll Address xxxx 3 Description xxxx 4 Assembly Date xxxx 5 Assembly Number xxxx 6 Short Tag xxxx 7 Long Tag xxxx 8 Dev ID xxxx
Device Setup	1 Operations 2 Diagnostics 3 Event History 4 Settings 5 Account	1 Change Password 2 Set Time 3 Set Date	

Menu Navigation

Menu options can be selected by highlighting the option and pressing Enter, by pressing the number of the option, or by double clicking on the option. For more information on how to select menu options please see the instructions for the HART host device being used.

Error Reporting

Searchzone Sonik implements HART protocol Command 48, meaning that if any event is detected in the detector while a HART host is connected, it will be reported immediately. Therefore warning messages may pop up during other operations.

10.3 Commissioning using HART Communications

Note:

The instructions that follow assume that a suitable HART host is connected to the Searchzone Sonik and that the user is logged in with 'Engineer' profile access privileges.

Introduction

This section explains several operations that may be required during commissioning. The user should work through First Time Switch On, User Configuration and Configure Device Identification Information, before selecting further operations as required by the specific installation.

First Time Switch On	Verifications required on first power up.
User Configuration	How to change settings from the default values: Change the Password – how to change the password for 'Engineer' profile access. Set the Time and Date - how to adjust the real time clock to local time. Configure Warning, Inhibit and Over-range Signal Levels - how to change the signal levels from the default settings.
Configure Detection Algorithm Mode	How to set algorithm mode for gas leak detection
Test 4-20 mA Loop Integrity	How to force the mA output to set levels to test the system. How to check that there is sufficient compliance in the loop to signal alarm and over-range.
Configure Alarm Set Point	How to change the internal threshold used to log gas leak events.
Output Test	How to test the system by simulating Alarm, Warning and Fault conditions for Relay and mA loop.
Clear Latch	How to clear alarm latch generated during commissioning.

CAUTION

After changing any parameter, poll the Searchzone Sonik and verify that the received value is correct.

First Time Switch On

Note:

Searchzone Sonik is supplied ready for use. It does not require calibration during commissioning.

Note:

During commissioning the 4-20 mA output can be monitored either at the control room or locally with a multimeter. When connecting or disconnecting a multimeter, power off Searchzone Sonik, otherwise the detector will indicate a latched warning that the 4-20 mA loop was broken. If this occurs it can be cleared using HART communications.

1. Before applying power to the detector, ensure that the field wiring is correct and all electrical connections are correctly set up. Refer to the *Electrical Installation* section of this manual for more information.
2. Apply power. Check that the supply voltage to Searchzone Sonik is between 18 and 32 Vdc. Monitor the 4-20 mA output during the startup sequence, which should be as follows:

CURRENT OUTPUT	DURATION
< 1 mA	< 30 s
4 ± 0.05 mA	ongoing

Note:

Depending on the mA Operation Mode that is selected, if gas leak is present, the detector will indicate a gas leak SPL reading.

Note:

If the output reverts to 3 mA or < 1 mA, a Warning or Fault is present. Follow the instructions below to investigate and clear a Warning or Fault (see Clear Faults or Warnings).

If local regulations or site practices require that a gas leak test is done to check that the detector is functioning, refer to the *Maintenance* section of this manual for more instructions.

10.3.1 User Configuration

Change the Password

It is recommended that the password for 'Engineer' profile access should be changed from the default setting. The password is 8 digit alphanumeric (case sensitive). A full 8 digit password should be used.

1. Select **Device Setup**.
2. Select **Account**.
3. Select **Change Password**.
4. Enter the password xxxxxxxx (eight characters, Alphanumeric, case sensitive) and press **Enter**.
5. The display shows a confirmation message, press **OK**.
6. Press **Back** to return to the Device Setup menu.

Note:

Some HART handheld devices contain a default password or hold a previously used password. Ensure that the desired password is entered in before pressing Enter.

Set the Time and Date

Searchzone Sonik has a real time clock, which is factory set to UTC time.

Note:

Do NOT set HART to non-UTC time. The mobile App auto-translates detector's UTC timestamps to local timestamps. Changing detector's UTC setting may cause connection issues.

1. Select **Device Setup**.
2. Select **Account**.
3. Select **Set Time**.
4. Enter the correct time (24 hour format) and press **Enter**.
5. The display shows a confirmation message, press **OK**.
6. Select **Set Date**.
7. Enter the correct date (dd/mm/yyyy format) and press **Enter**.
8. The display shows a confirmation message, press **OK**.
9. Press **Back** to return to the Device Setup menu.

10.3.2 Configure Warning, Inhibit and Over-range Signal Levels

The Warning, Inhibit and Over-range signal levels can be changed from the default values.

The default levels and ranges are:

Parameter	Default	Range
Fault	1 mA	0 mA to 3.6 mA
Inhibit	2 mA	1 mA to 3.6 mA
Warning	3 mA	1 mA to 4 mA
Over-range	21 mA	20 mA to 22 mA

The tolerance on the nominal current output value is ± 0.2 mA.

1. Select **Device Setup**.
2. Select **Settings**.
3. Select **mA Loop**.
4. Select **Inhibit Level**.
5. Enter the new value for the current within the allowed range and press **Enter**.
6. Select **Warning Level**.
7. Enter the new value for the current within the allowed range and press **Enter**.
8. Select **Over Range Level**.
9. Enter the new value for the current within the allowed range and press **Enter**.
10. Press **Back** to return to the Settings menu.

Note:

If a value is sent which is outside the allowed range, it will be rejected. Searchzone Sonik will offer the option to restore the previous value or re-enter another value.

10.3.3 Configure Device Identification Information

Searchzone Sonik can hold information programmed by the user, such as an identification number (tag) or site specific details. Five text fields are available:

- Description – up to 16 characters
- Assembly Date – mm/dd/yy
- Assembly Number – up to 8 characters
- Short Tag - up to 8 characters
- Long Tag – up to 32 characters

The fields for Description, Assembly Date and Assembly Number are undefined until they have been configured.

Note:

Short Tag and Long Tag are commonly used by HART hosts to identify individual devices (even when a handheld device is connected directly to Searchzone Sonik). These fields must not be left blank.

1. Select **Device Setup**.
2. Select **Settings**.
3. Select **HART**.
4. Select **Configure HART**.
5. Select **Description**.
6. Enter required information up to 16 characters (for example the device type) and press **Enter**.
7. Select **Assembly Date**.
8. Enter required information in the format mm/dd/yy (for example the date of installation) and press **Enter**.
9. Select **Assembly Number**.
10. Enter required information up to 8 characters (for example a number related to the installation) and press **Enter**.
11. Select **Short Tag**.
12. Enter required information up to 8 characters (for example a unique device identification number) and press **Enter**.
13. Select **Long Tag**.
14. Enter required information up to 32 characters (for example the device location) and press **Enter**.
15. Press **Send** to send the information to Searchzone Sonik.
16. Return to the home screen.

10.3.4 Test 4-20 mA Loop Integrity

It is recommended that the 4-20 mA loop integrity is tested by setting the Searchzone Sonik to output an over-range current. This will confirm that there are no faults in the system that would cause a current limit.

Note:

By default, this function will timeout after 10 minutes of inactivity.

Note:

When connecting or disconnecting a multimeter, power off the Searchzone Sonik, otherwise the detector will indicate a fault warning that the 4-20 mA loop was broken.

1. Select **Device Setup**.
2. Select **Operations**.
3. Select **Output Test**.
4. Select **Force Loop**.
5. Select **Apply Force Loop**.
6. Select between **4 mA**, **20 mA** or **Custom**.
7. The display shows a warning message, press **OK**. Searchzone Sonik will now output the chosen value in mA.
8. Select **End**.
9. The display shows a note that the Searchzone Sonik will return to normal operation, press **OK**.

Note:

If the current at the controller is not correct, check the 4-20 mA loop connections and cabling, and check that the loop resistance is less than 600 Ω . In current source mode, for supply voltages of 18 to 20 Vdc the maximum loop resistance is 500 Ω .

Note:

If the product cannot generate the required output current it will move to a fault condition after a very short period of time.

10.3.5 Configure Internal Alarm Threshold

The internal alarm setpoint is used to log events when the gas leak reading exceeded the threshold. It is also used as the value to simulate Alarm. The default value is 60 dB.

1. Select **Device Setup**.
2. Select **Settings**.
3. Select **Alarms**.
4. Select **Configure Alarms**.
5. Select **Change Alarm Set Point**.
6. Enter new value in dB. Press **Enter**, then press **Save** to send the information to Searchzone Sonik.
7. Return to the home screen.

10.3.6 Clear Alarm Latch

During commissioning alarm or fault latches may be generated. This will be indicated by the 4-20 mA output signal. Use the procedure below to clear them.

1. Select **Device Setup**.
2. Select **Diagnostics**.
3. Select **Active Faults** or **Active Warnings** to check for any faults or warnings.
4. Select **First** or **Next** to display the fault or warning.

Note:

“First” displays the active fault or warning that occurred earliest in time. “End of list” means that the last fault or warning has been reached.

5. Press **OK** and use the back button to return to Diagnostics menu.

Note:

If no active faults or warnings are present, the 4-20 mA output signal may have latched due to an earlier alarm that has now cleared.

6. Press **Back** to return to the Device Setup menu.
7. Select **Operations**.
8. Select **Clear Latch**.
9. Press **OK** to initiate a Device Reset, which will clear any latched faults or warnings.

Note:

If any configuration changes have been made, wait 15 seconds before doing a soft reset or cycling the power.

10. The display shows a confirmation message. Press **OK**.
11. Return to the home screen.

10.4 Maintenance using HART Communications

Note:

The instructions that follow assume that a suitable HART host (handheld or PC) is connected to the Searchzone Sonik and that the user is logged in 'Engineer' profile access privileges.

This section explains how to perform common maintenance operations. Please refer to IEC/EN 60079-29-2 or other local or national regulations for guidance on establishing an appropriate maintenance routine.

Inspection	How to check for damage and clean the unit
Proof Test (Gas Leak Challenge)	How to carry out a gas leak test using a canister of compressed air
Investigation of Faults or Warnings	How to view Faults and Warnings

CAUTION

After changing any parameter, poll the Searchzone Sonik and verify that the received value is correct.

10.4.1 Inspection

Searchzone Sonik should be inspected periodically and cleaned if necessary. The required frequency of inspection will depend on local site conditions and will need to be established through experience.

CAUTION

Gas leak alarms may be generated during this procedure. Follow the steps to inhibit the 4-20 mA output.

WARNING

Ensure that the detector is not unintentionally left in an inhibit state.

1. Select **Device Setup**.
2. Select **Operations**.
3. Select **Inhibit Detector**.
4. Select **Start Inhibit**.
5. Press **OK** to confirm.
6. A confirmation message is shown informing that Inhibit Mode is started. Press **OK**. The 4-20 mA output is now inhibited. Inspect the Searchzone Sonik unit and cabling for any signs of physical damage.
7. Clean any dust or dirt from the Searchzone Sonik unit using soapy water and a soft cloth.
8. Select **Device Setup**.
9. Select **Operations**.
10. Select **Clear Latch** to clear any faults or warnings that may have been generated by cleaning.

11. Press **OK** to confirm the operation.
12. The display shows a confirmation message. Press **OK**.
13. The display shows a note that the Searchzone Sonik will return to normal operation, press **OK**.

10.4.2 Proof Test (Gas Leak Challenge)

Searchzone Sonik can be functionally checked using a canister of compressed air. Refer to the *Maintenance* section of this manual for more instructions.

10.4.3 Investigation of Faults or Warnings

If the detector is signalling Fault or Warning on the 4-20 mA output, the problem should be investigated and remedied as soon as possible.

1. Select **Device Setup**.
2. Select **Diagnostics**.
3. Select **Active Faults** or **Active Warnings** to check for any faults or warnings.
4. Select **First** or **Next** to display the fault or warning.

Note:

First displays the fault or warning that occurred earliest in time.

5. Press **Back** to return to the Device Setup menu.
6. Select **Operations**.
7. Select **Clear Latch**.
8. Press **OK** to initiate a Device Reset, which will clear any latched faults or warnings.

Note:

If any configuration changes have been made, wait 15 seconds before doing a soft reset or cycling the power.

9. The display shows a confirmation message. Press **OK**.
10. Return to the home screen.

Note:

If any configuration changes have been made, wait 15 seconds before doing a soft reset or cycling the power.

11. The display shows a confirmation message. Press **OK**.
12. The display shows a note that the Searchzone Sonik will return to normal operation, press **OK**.
13. Return to the home screen.

10.5 Modbus

The Searchzone Sonik detector provides a facility for Modbus digital communication between Searchzone Sonik and an external controller. Modbus is a widely-supported digital data communication protocol that provides a standardised set of data communication protocols. The principal features of the Modbus Interface are:

- Operates as a Modbus Remote Terminal Unit (RTU) slave device node.
- Supports functions 03 and 06 of the Modbus protocol.
- Provides gas leak sound pressure dB reading and alarm status for Inhibit, Fault, Alarm and Warning.
- RS-485 half-duplex communication with multi-drop capability.
- Asynchronous serial link configurable for baud rate and parity.

NOTE

The Modbus broadcast commands are not supported and will be ignored.

10.5.1 Programming the Host

The host computer system must be programmed to interpret the signal and status data received from Searchzone Sonik as there is no standard Modbus format for the communication of data from gas leak detection systems.

It is recommended that the host computer system should, as a minimum, be programmed to use Function 03 to collect alarm and status data from Searchzone Sonik.

Full details of the Modbus protocol can be found in the Modicon Modbus Protocol Reference Guide PI-MBUS-300 available at www.modbus.org.

CAUTION

Some transceiver manufacturers assign RS-485 pin A as data positive and pin B as data negative. You may have to transpose TDA and TDB (A in and B in) if your Modbus does not work as expected.

10.5.2 Addressing Conventions and Register Values

The addressing conventions and register values used follow those set by Modicon.

4xxxx – The Holding registers are used to read Searchzone Sonik alarm status and few configuration parameters. An address range is used to query the event record and store the result.

The write-only registers can be written singly using Function code 06.

Modbus communication settings can be updated using the write registers.

10.5.3 Modbus Cables

The cable should be an RS-485 shielded data communication cable suited to the installation distance, ambient and environmental factors.

Note:

- Spurs shall not be longer than 1m (39 in.) each, and shall not exceed 10m (33 ft.) combined total.
- The maximum cable length without line repeaters is 1.2km (3900ft).
- The minimum wire size is 1.5 mm² (15 AWG), maximum is 2.5 mm² (13 AWG).

10.5.4 Modbus Electrical Connections

Modbus connections are provided through the terminals in the wiring compartment of the Searchzone Sonik detector. Details of the wiring connections can be found in section 6.4.1 of this manual.

10.5.5 Modbus Termination Resistor

If Searchzone Sonik is the last node in a Modbus system highway a 120 Ω termination resistor between A and B must be fitted to avoid reflections on the RS-485 circuit.

Note

The 120 Ω termination resistor is NOT supplied.

10.5.6 Modbus Multi-Drop Mode

A maximum of 32 nodes (31 slave nodes plus one master node) are supported in a multi-drop installation.

10.5.7 Modbus Protocol

Authoritative information on the Modbus protocol can be found at www.modbus.org.

Supported baud rates are 9600 and 19200 with 9600 as the default (none parity, 1 stop bit) and slave address is set as 1 by default.

Status reading and configuration of important parameters (adjustable with the Searchzone Sonik Mobile App and HART) can also be performed using the Modbus interface. This appendix describes only how to monitor Searchzone Sonik status using Modbus.

10.5.8 Modbus Registers

Modbus Holding Register Address	Qty	Register Type	Parameter Description	Description	Notes
40001	1	r	Modbus slave address	MSB -> 0x27 LSB -> Slave address (1 to 247)	Note 4
40002	1	r	Detector Id	Identical to 40001	Note 4
40003 to 40004	2	r	SPL dB value	Reported gas leak level - Value of SPL for full spectrum	
40005	1	r	Not used	-----	
40006	1	r	Detector detail status	-----	Note 2
40007	1	r	Operating state	-----	Note 6
40008	1	r	Alarm Latch config	-----	
40009 to 40010	2	r	Discrete or proportional	-----	
40011	1	r	Measurement unit	-----	Note 3
40012 to 40014	3	r	Relay status (Active/Inactive)	-----	
40015	1	r	ADC Temp. Sensor	-----	
40016	1	r	PSU1 Temp. Sensor	-----	
40017	1	r	AFE Temp. Sensor	-----	
40018 to 40030	13	r	Device Name	From Bluetooth	Note 9
40031 to 40035	5	r	Not used	-----	
40036	1	r	Sensor type	-----	Note 8
40037 to 40038	2	r	mA Output	Set value is not used(F32_OPCTL_MAOP_CURRENT)	
40039	1	r	Voltage monitor	24V_PROT_SW	Note 10
40040	1	r	Voltage monitor	5V0_SAFE	Note 10
40041	1	r	Voltage monitor	12V_SAFE	Note 10
40042	1	r	Voltage monitor	3V3_SAFE	Note 10
40043	1	r	Voltage monitor	12V	Note 10
40044	1	r	Voltage monitor	3V3	Note 10
40045	1	r	Voltage monitor	5V0	Note 10
40046	1	r	Voltage monitor	1V2_SAFE	Note 10
40047	1	r	Voltage monitor	2V5_SAFE	Note 10
40048 to 40052	5	r	Not used	-----	
40053 to 40059	7	r	Not used	-----	
40060	1	r	Voltage monitor	2V5_REF	Note 10
40061	1	r	Configuration counter	From HART	
40062 to 40074	13	r	Not used	-----	
40075 to 40081	7	r	Serial number	-----	Note 9
40082 to 40083	2	r	Not used	-----	
40084	1	r	Detector version	Hw	
40085	1	r	Detector version	Sw	
40086 to 40088	3	r	Voltage monitor	8V0_SAFE, 5V_HTR, INTRA_1V2	Note 10
40089 to 40090	2	r	mA - A1 level	-----	
40091 to 40092	2	r	mA - A2 level	-----	
40093 to 40094	2	r	mA - A3 level	-----	

Modbus Holding Register Address	Qty	Register Type	Parameter Description	Description	Notes
40095 to 40096	2	r	mA - A4 level	-----	
40097 to 40098	2	r	Not used	-----	
40099 to 40102	4	r	Not used	-----	
40103 to 40104	2	r	Not used	-----	
40105 to 40106	2	r	Alarm delay	-----	
40107 to 40108	2	r	SPL configured	Alarm set point	
40109 to 40110	2	r	Not used	-----	
40111 to 40112	2	r	Not used	-----	
40113 to 40114	2	r	Not used	-----	
40115	1	r	Proof test interval	-----	
40116 to 40122	7	r	Not used	-----	
40123	1	r	Relay configuration	-----	Note 5
40124 to 40142	19	r	Not used	-----	
40143 to 40144	2	r	Timestamp	-----	
40145	1	r	Not used	-----	
40146 to 40154	9	r	Event block - read	Event data	Note 1
40155	1	w	Event command	Event command	Note 7
40156	1	w	Modbus slave address	-----	
40157	1	w	Baudrate	9600, 19200	
40158	1	w	Parity	even, odd or none	
40159	1	w	Stop bits	0 or 1	

Note 1 - Event response format

2 registers	Date/Time
1 register	Event category; 1=alarm; 2=fault; 3=warning; 5=informational
2 registers	Event type
2 registers	Argument 1
2 registers	Argument 2

Note 2 - Meaning of Detector detail status

bit 0	Alarm1/Pre-alarm is active	bit 8	Inhibit
bit 1	Alarm2/Alarm is active	bit 9	Alarm0/Test signal1
bit 2	Overrange	bit 10	Alarm3/Test signal2
bit 3	for future expansion	bit 11	for future expansion
bit 4	Warning is active	bit 12	for future expansion
bit 5	Fault is active	bit 13	for future expansion
bit 6	for future expansion	bit 14	for future expansion
bit 7	for future expansion	bit 15	for future expansion

Note 3 - Definition of Measurement unit

0	invalid
12	flame detected bit
13	leak detected by Searchzone Sonik
14 to 255	for future expansion

Note 4 - Meaning of Modbus Address

MSByte	LSByte
0x27	Modbus Address

Note 5 - Definition of Relay configuration

bit num	name	def. val	0 - De-energized 1 - Energized 0 - Non-latching 1 - Latching
bit 0	Relay 1 Energized/De-energized	1	
bit 1	Relay 2 Energized/De-energized	0	
bit 2	Relay 3 Energized/De-energized	0	
bit 3	Relay 1 Latch	0	
bit 4	Relay 2 Latch	0	
bit 5	Relay 3 Latch	0	
bit 6	reserved		
bit 7	reserved		
bit 8	reserved		
bit 9	reserved		
6 to 15	unused in Searchzone Sonik		

Note 6 - Definition of Operating state

Value	Precedence	Meaning
0	n/a	reserved
1	8	normal monitoring
2	7	warm-up/start-up
3	6	inhibit
4	1	alarm
5	2	not used
6	3	not used
7	5	warning
8	4	fault
9 to 255	n/a	for future expansion

Note 7 - Definition of Event commands

Command	Value of Command (MSB byte, LSB byte)
get newest record	Group, 0x18
get oldest record	Group, 0x19
get next newer event	Group, 0x1A
get next older event	Group, 0x1B
	Group definition: Group value can be set from 0 to 2 Group 0 – internal and security events (and all other uncategorised events) Group 1 – alarm and proof test events Group 2 – service events

Note 8 - Meaning of Sensor type

0	invalid, no sensor found of mV default
10	Searchzone Sonik
11 to 255	for future expansion

Note 9 - The register is used to store two ASCII codes

Note 10 - The float value of voltage/temperature is multiplied with 100 to get 2 decimal point (e.g., 3.2 should be read as 320).

11 Maintenance

The Searchzone Sonik detector should periodically be inspected, cleaned and tested. The required frequency of inspection will depend on the hazardous area risk and maintenance plan. Please refer to IEC/EN 60079-29-2 or other local or national regulations for guidance on establishing an appropriate maintenance routine.

The detector requires little maintenance other than occasional cleaning. Depending on the local regulations and site conditions, cleaning and functional testing of the detector can be carried as described in the following sub-sections. The detector should remain powered during these procedures.

CAUTION

The Searchzone Sonik does not contain any user serviceable parts. Do not open the main enclosure. Doing so will invalidate the warranty.

CAUTION

Seek authorized service in case of detector failure or malfunction.

Note

The Searchzone Sonik detector requires no calibration. Periodically perform a proof test on the detector.

11.1 Inspection and Cleaning

CAUTION

Do not use solvents or abrasives on the Searchzone Sonik unit.

- 1) Inspect the Searchzone Sonik unit and cabling for signs of physical damage.
- 2) Clean any dust or dirt from the Searchzone Sonik unit using soapy water and a soft cloth.

11.2 Periodic Proof Test using a Canister of Compressed Air

Using a mobile device running the Searchzone Sonik App, connect to the Searchzone Sonik detector. If required, place the detector into an inhibit state.

Obtain a full canister of compressed air.

Stand directly in front of the Searchzone Sonik detector at a distance of no greater than 5 m (16.4 ft).

Depress the nozzle of the compressed air canister to open the valve. Check that the Searchzone Sonik detector responds accordingly.

Note that as the nozzle cools due to the release of compressed air, the characteristics of the ultrasonic noise produced will change significantly. Always allow sufficient time for the nozzle to return to normal temperature before repeating any tests.

If the Searchzone Sonik detector was placed in an inhibit condition for the test, use the Searchzone Sonik App to return the detector to normal operation.

11.3 Suggested Maintenance Schedule

The maintenance schedule will reflect local working environment and should be agreed with Honeywell representatives prior to commissioning the Searchzone Sonik.

11.4 Response to Fault

Refer to the *Problem Solving* section of this manual for more information.

11.5 Product Life Expectancy

The expected operating life of the Searchzone Sonik detector is 10 years.

12 Problem Solving

12.1 Introduction

It is recommended to use the **Searchzone Sonik mobile App** as the **primary** troubleshooting tool. Optionally, a HART hand held unit can be used to carry out diagnostics.

Refer to the troubleshooting table below for a list of problems, possible causes and remedy actions.

Note

The Searchzone Sonik detector continues to function as a gas leak detector while indicating Warning, although aspects of its performance may be reduced. A Warning is an indication of a potential future problem.

CAUTION

1. Searchzone Sonik does not contain any user serviceable parts. Do not open the main enclosure. Doing so will invalidate the warranty.
2. If a problem persists please contact Honeywell Analytics for advice, using the contact details given on the back page.
Have the following information to hand:
 - A description of the application and the problem, including the steps taken in attempt to resolve it
 - The serial number of the Searchzone Sonik unit (see the label on the end cap)
 - The service log downloaded from the mobile App (refer to the *Mobile App* section of this manual)

If connected to Searchzone Sonik using HART, search for the following information by selecting Device Info from the Device Setup menu:

 - Dev id (unique Searchzone Sonik identification number)
 - Fld dev rev (revision number of the HART DD file)
 - Software rev (Searchzone Sonik software revision number)
 - Hardware rev (Searchzone Sonik hardware revision number)
3. Flamepaths are not to be repaired.
4. The equipment shall be connected to circuits providing Overvoltage Category II or better according to IEC/EN 60664-1.
5. To minimize the risk of electrostatic charge, provisions shall be made for an adequate grounding of the equipment, including accessories (e.g. sunshade). Equipment shall be installed in a manner so that accidental discharge shall not occur.

CAUTION

Some types of faults and warnings will latch the 4-20 mA output and need to be cleared by a Reset, which will clear latched events. Faults and warnings will fail to clear if they are still active.

12.2 Problem Solving

Fault / Problem	Description	Remedial Action
Detector does not power up and does not follow the start-up cycle	Power supply is not available	Check that power is available and to specification
	Power supply is not within specification	Check that LED indicator in on
	Wiring connections are not made correctly	Check wiring connections
	External ambient temperature is below -55°C or above +75°C	Check the ambient operating temperature. When Ex certified equipment is operated outside its certified range, its type approval certification is invalidated along with its warranty. Such equipment should be removed from service in potentially explosive atmospheres
	External ambient temperature is below -30°C but above -55°C	When external temperature is below -30°C the detector appears as not being powered during its warm-up phase. LED status indicator is powered off, relays de-energized and mA output is 0 mA. Internal heaters are active and after a heat-up period the detector initiates standard start-up cycle. Warm-up period duration depends on external ambient temperature, to a maximum of 30 minutes at -55°C. A good indication of the heaters being active is the detector increased power consumption of approximately 15 W
	Internal non-recoverable fault	Return the detector to authorized service
Detector powers up and goes through start-up sequence, then shows fault (LED indicator goes amber)	Power supply is not within specification	Check that power is to specification
	mA loop is not wired correctly	Check the mA loop wiring and rectify as necessary
	mA loop external power supply and loop impedance is not to specification	Check that mA loop external power supply and loop impedance is to specification
	Power On Self Test failed	Interrogate event log to determine which diagnostic failed Re-power the detector and check if the fault clears Otherwise return the detector to base
Detector shows fault but power and mA are correct	Diagnostic failure	Power cycle the detector Run diagnostics with the Searchzone Sonik mobile App (menu Diagnostics - Logs) Return the detector to authorized service
	Resistor is not fitted between mA- and 0 Vdc or between mA+ and +24 Vdc terminals	Add a suitable load resistor between mA- and 0 Vdc or between mA+ and +24 Vdc terminals
Detector shows warning	Ambient operating temperature or power is just over or just below specification	Check location for heat sources Fit with a sunshade or other protection Change detector location
Detector is in inhibit state	Detector has been inhibited by the Searchzone Sonik mobile App or by HART hand held device	Release the output from inhibit state using the Searchzone Sonik mobile App or HART hand held device
	Force command has been given by the Searchzone Sonik mobile App or HART hand held device	
4-20 mA output appears to be unstable	Electrical interference being induced on 4-20 mA cabling	Check for earth loops Confirm that the cable screen is earthed correctly Investigate noise on the signal using an oscilloscope For noisy installations, consider using filtering and signal processing at the control card
	Poor contacts	Check terminal connections If necessary tighten the connectors Excessive vibration can loosen connections Identify and minimise potential sources of vibration

Fault / Problem	Description	Remedial Action
4-20 mA output is in fault	4-20mA loop wiring has been disturbed	Check 4-20mA loop is correctly connected and terminated Reset the fault using the App or HART If the fault persists, power cycle the detector If the fault still persists, contact Authorized Service
Detector indicates Fault following an over-range condition	After over-range cleared, detector indicates Fault for another 30 seconds	The over-range condition indicates that the detector was exposed to an extremely high sound pressure level, normally indicating a large gas leak. This should be immediately investigated. The fault indication is an intended result of the detector reporting over-range and will clear automatically 30 seconds after the alarm condition is cleared
Modbus communication error	Incorrect communication connection	Check that detector RS-485 A and B wires have been connected to the correct terminals of the controller Check if baud rate is set up correctly Check if data format is set up correctly Check if address is set up correctly
	Detector is not powered up	Check that power is available and to specification
	No termination of long cable run	For cable runs longer than 100 m use termination resistors 120 Ohm connected between RS-485 A and B wires at each end of the communication bus
	Incorrect wiring topology	Check that any spurs are less than 1 m in length and do not exceed the total length limit of 10 m.
Detector gives nuisance alarms	Alarm threshold set too low	Use the background noise feature on the mobile App to determine peak background noise. Adjust threshold to be at least 3 dB above the current peak level
	Delay parameter set too short	Determine any intermittent noise sources. Set detector's delay parameter longer than duration of the nuisance noise sources
	Operating Mode set incorrectly	Select appropriate Operating Mode as per product siting considerations
Detector fails to raise alarm	Alarm threshold set too high or Delay parameter set too long	Review product settings and its position against the leak source
	Operating Mode set incorrectly	Select appropriate Operating Mode as per product siting considerations
The Searchzone Sonik Mobile App reports do not show time and date stamp	No information on time and date of creation is given in the Searchzone Sonik mobile App report	Internal battery cell has to be replaced. Return the detector to authorized service
Detector registration failed	Incorrect entry of registration details	Check if registration details have been correctly entered
	Invalid registration details	Check if registration details are valid for the intended detector
	Detector already registered	Check if the detector has not already been registered to the same or other company

Note

Use the Searchzone Sonik mobile App to run diagnostics and obtain information on faults and errors.

13 Certification and Approvals

The Searchzone Sonik detector has attained the below listed approvals:

13.1 Hazardous Locations

WARNING

The equipment provides isolation according to IEC/EN 60079-11 clause 6.3.13 between circuits and earth.

The equipment provides isolation according to UL/CSA 60079-11 clause 6.3.13 between circuits and earth.

CAUTION

Special conditions for safe use:

1. To minimize the risk of electrostatic charge, provisions shall be made for an adequate grounding of the equipment, including accessories (e.g. sunshade). Equipment shall be installed in a manner so that accidental discharge shall not occur.
2. The equipment shall be connected to circuits providing Overvoltage Category II or better according to IEC/EN 60664-1
3. Flamepaths are not to be repaired.

13.2 ATEX Certification



II 2GD

DEMKO 18 ATEX 1866X

Ex db ia IIC T4 Gb (for flameproof Ex d installations)

Ex db eb ia IIC T4 Gb (for increased safety Ex e installations)

Ex tb IIIC T100°C Db

Tamb -55°C to +75°C (-67°F to +167°F)

Um = 250 Vrms

CENELEC standards:

- CENELEC EN 60079-0 EXPLOSIVE ATMOSPHERES - PART 0: EQUIPMENT - GENERAL REQUIREMENTS (2012) + A11:2013
- CENELEC EN 60079-1 EXPLOSIVE ATMOSPHERES - PART 1: EQUIPMENT PROTECTION BY FLAMEPROOF ENCLOSURES 'D' (2014)
- CENELEC EN 60079-7 EXPLOSIVE ATMOSPHERES - PART 7: EQUIPMENT PROTECTION BY INCREASED SAFETY 'E' (2015)
- CENELEC EN 60079-11 EXPLOSIVE ATMOSPHERES. PT. 11, EQUIPMENT PROTECTION BY INTRINSIC SAFETY "I" (2012)
- CENELEC EN 60079-31 EXPLOSIVE ATMOSPHERES - PART 31: EQUIPMENT DUST IGNITION PROTECTION BY ENCLOSURE 'T' (2014)

13.3 IECEx Certification

IECEx ULD 18.0016X

Ex db ia IIC T4 Gb (for flameproof Ex d installations)

Ex db eb ia IIC T4 Gb (for increased safety Ex e installations)

Ex tb IIIC 100°C Db

Tamb -55°C to +75°C (-67°F to 167°F)

Um = 250 Vrms

IEC Standards:

- IEC 60079-0, Explosive atmospheres – Part 0: Equipment – General requirements - Edition 6th Edition (2011-06) + CORR. 1 (2012-01) + CORR 2 (2013-12) + I-SH 01 (2013-11) + I-SH 02 (2014-10)
- IEC 60079-1, Explosive atmospheres – Part 1: Equipment protection by flameproof enclosures “d” - Edition 7th Edition (2014-06)
- IEC 60079-7, Explosive atmospheres – Part 7: Equipment protection by increased safety “e” - Edition 5th Edition (2015-06) + I-SH 01 (2016-09)
- IEC 60079-11, Explosive atmospheres – Part 11: Equipment protection by intrinsic safety “i” - Edition 6th Edition (2011-06) + CORR. 1 (2012-01) + I-SH 01 (2014-10) + I-SH 02 (2016-07) + I-SH 03 (2016-07)
- IEC 60079-31, Explosive atmospheres – Part 31: Equipment dust ignition protection by enclosure “t” - Edition 2nd Edition (2013-11)

13.4 CSA Certification

Class I, Division 1, Groups. B,C,D, T4, Ta -55°C to +75°C (-67°F to 167°F)

Class II, Division 1, Groups. E,F,G, T4, Ta -55°C to +55°C (-67°F to 131°F)

Class III Div. 1

Ex db ia IIC T4 Gb X, Ta -55°C to +75°C (-67°F to 167°F)

Ex db eb ia IIC T4 Gb X, Ta -55°C to +75°C (-67°F to 167°F)

Ex tb IIIC T100°C Db X, Ta -55°C to +55°C (-67°F to 131°F)

Um = 250 Vrms

CSA Standards:

- CSA C22.2 NO. 60079-0:2015 EXPLOSIVE ATMOSPHERES – PART 0: EQUIPMENT – GENERAL REQUIREMENTS- Edition 3 (2015-10)
- CSA C22.2 NO. 60079-1:2016 EXPLOSIVE ATMOSPHERES – PART 1: EQUIPMENT PROTECTION BY FLAMEPROOF ENCLOSURES ‘D’- Edition 3 (2016-05)
- CSA C22.2 NO. 60079-7:2016 EXPLOSIVE ATMOSPHERES - PART 7: EQUIPMENT PROTECTION BY INCREASED SAFETY “E”- Edition 2 (2016-10)
- CSA C22.2 NO. 60079-11:2014 EXPLOSIVE ATMOSPHERES - PART 11: EQUIPMENT PROTECTION BY INTRISIC SAFETY “I”- Edition 2 (2014-02)
- CSA C22.2 NO. 60079-31:2015 EXPLOSIVE ATMOSPHERES - PART 31:2015 EQUIPMENT DUST IGNITION PROTECTION BY ENCLOSURE ‘T’ - Edition 2 (2015-10)
- CAN/CSA C22.2 NO. 25-17, ENCLOSURES FOR USE IN CLASS II DIVISION 1 GROUPS E, F, AND G HAZARDOUS LOCATIONS, 4TH EDITION
- CSA C22.2 NO. 30-M1986 EXPLOSION-PROOF ENCLOSURES FOR USE IN CLASS I HAZARDOUS LOCATIONS- Edition 1 - Revision Date 2003/01/01, Reaffirmed 2016

13.5 cULus Certification

Class I, Division 1, Groups. B,C,D, T4, Ta -55°C to +75°C (-67°F to 167°F)

Class II, Division 1, Groups. E,F,G, T4, Ta -55°C to +55°C (-67°F to 131°F)

Class III Div. 1

Class I Zone 1 AEx db ia IIC T4 Gb, Ta -55°C to +75°C (-67°F to 167°F)

Class I Zone 1 AEx db eb ia IIC T4 Gb, Ta -55°C to +75°C (-67°F to 167°F)

Zone 21 AEx tb IIIC T100°C Db, Ta -55°C to +55°C (-67°F to 131°F)

Um = 250 Vrms

UL standards:

- UL 60079-0 UL STANDARD FOR SAFETY EXPLOSIVE ATMOSPHERES - PART 0: EQUIPMENT - GENERAL REQUIREMENTS- Edition 6th (2013-07).
- UL 60079-1 UL STANDARD FOR SAFETY EXPLOSIVE ATMOSPHERES - PART 1: EQUIPMENT PROTECTION BY FLAME-PROOF ENCLOSURES ‘D’- Edition 7th (2015-09).

- UL 60079-7 UL STANDARD FOR SAFETY EXPLOSIVE ATMOSPHERES - PART 7: EQUIPMENT PROTECTION BY INCREASED SAFETY 'E'- Edition 5th (2017-02)
- UL 60079-11 UL STANDARD FOR SAFETY EXPLOSIVE ATMOSPHERES - PART 11: EQUIPMENT PROTECTION BY INTRINSIC SAFETY 'I'- Edition 6th (2014-02)
- UL 60079-31 UL STANDARD FOR SAFETY EXPLOSIVE ATMOSPHERES - PART 31: EQUIPMENT DUST IGNITION PROTECTION BY ENCLOSURE "T"- Edition 2 (2015-06)
- UL 1203 STANDARD FOR EXPLOSION-PROOF AND DUST-IGNITION-PROOF ELECTRICAL EQUIPMENT FOR USE IN HAZARDOUS (CLASSIFIED) LOCATIONS- Edition 5 (2015-10)
- UL 913 STANDARD FOR SAFETY INTRINSICALLY SAFE APPARATUS AND ASSOCIATED APPARATUS FOR USE IN CLASS I, II and III, DIVISION 1, HAZARDOUS (CLASSIFIED) LOCATIONS – 8th EDITION (2015-10)

13.6 Labelling

ATEX / IECEx certification label

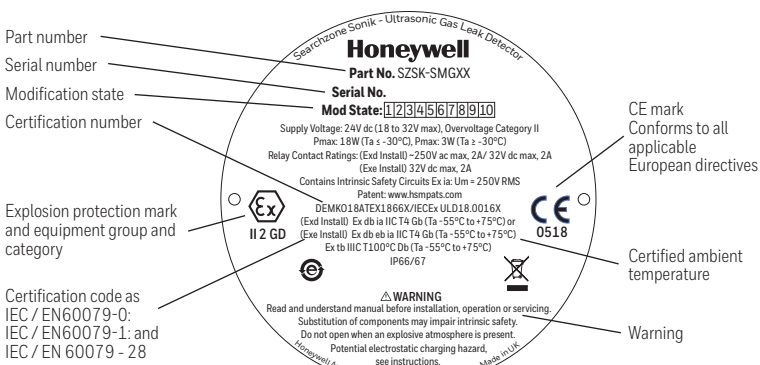

cULus certification label

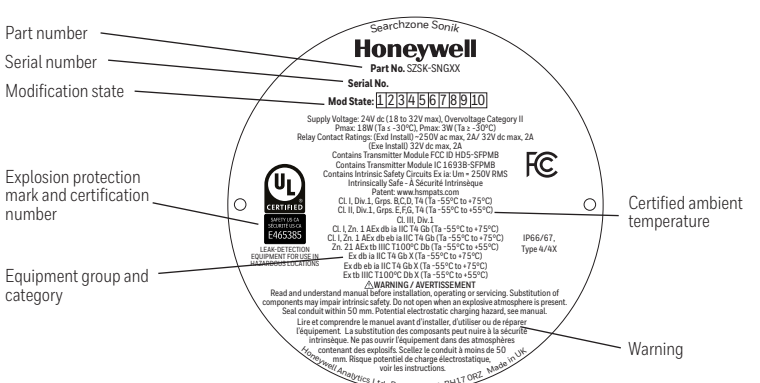

13.7 EU Declaration of Conformity

SIMPLIFIED EU DECLARATION OF CONFORMITY
 Hereby, Honeywell declares that the Searchzone Sonik equipment is in compliance with Directive 2014/53/EU. The full text of the EU declaration of conformity is available at: www.honeywellanalytics.com.

13.8 RoHS

Searchzone Sonik is compliant with all requirement and exemption set by the European RoHS 2.0 Directive 2011/65/EU and the European Delegated Directive (EU) 2015/863.

13.9 China RoHS

Searchzone Sonik is compliant with all requirement and exemption set by the China RoHS 2.0 Directive (2016).



13.10 WEEE



EU Directive 2012/19/EU: Waste Electrical and Electronic Equipment (WEEE)

This symbol indicates that Searchzone Sonik must not be disposed of as general industrial or domestic waste. Searchzone Sonik should be disposed of through suitable WEEE disposal facilities. For more information about disposal of Searchzone Sonik, contact your local authority, distributor or the manufacturer.

13.11 EMC

Searchzone Sonik is compliant with all requirement and exemption set by the Electromagnetic Compatibility (EMC) Directive 2014/30/EU.

13.12 RED

Searchzone Sonik is compliant with all requirement and exemption set by the Radio Equipment Directive (2014/53/EU).

13.13 REACH

Hereby, Honeywell declares that Searchzone Sonik fully complies with the related requirements of European Union Regulation (EU) 1907/2006 concerning the Registration, Evaluation, Authorization and Restriction of Chemicals (REACH).

13.14 FCC

Incorporates FCC: HD5-SFPMB

This detector complies with part 15 of the FCC Rules. Operation is subject to the following two conditions:

- 1) This detector may not cause harmful interference, and
- 2) This detector must accept any interference received, including interference that may cause undesired operation.

This detector must not be co-located or operated in conjunction with any other antenna or transmitter. This equipment complies with FCC radiation exposure limits set forth for an uncontrolled environment. End users must follow the specific operating instructions for satisfying RF exposure compliance.

Note

This equipment has been tested and found to comply with the limits for a Class A digital device, pursuant to part 15 of the FCC Rules. These limits are designed to provide reasonable protection against harmful interference when the equipment is operated in a commercial environment.

Note

This equipment generates, uses, and can radiate radio frequency energy and, if not installed and used in accordance with the instruction manual, may cause harmful interference to radio communications. Operation of this equipment in a residential area is likely to cause harmful interference in which case the user will be required to correct the interference at his own expense.

CAUTION

Changes or modifications not expressly approved by the manufacturer responsible for compliance could void the user's authority to operate the equipment.

13.15 IC

Incorporates IC: 1693B-SFPMB

WARNING

Searchzone Sonik has been tested and meets applicable limits for radio frequency (RF) exposure. According to the RF Exposure report, minimum 20 cm separate distance is required.

Searchzone Sonik a été testé et respecte les limites applicables à l'exposition aux radiofréquences (RF). Selon le rapport d'exposition RF, un minimum de 20 cm de distance séparée est nécessaire.

This detector complies with Industry Canada's licence-exempt RSSs. Operation is subject to the following two conditions:

- 1) This device may not cause interference; and
- 2) This device must accept any interference, including interference that may cause undesired operation of the device

Le présent appareil est conforme aux CNR d'Industrie Canada applicables aux appareils radio exempts de licence. L'exploitation est autorisée aux deux conditions suivantes:

- (1) l'appareil ne doit pas produire de brouillage;
- (2) l'utilisateur de l'appareil doit accepter tout brouillage radioélectrique subi, même si le brouillage est susceptible d'en compromettre le fonctionnement.

13.16 Export Compliance Classification

Searchzone Sonik has been classified as follows:

EU - No License Required (NLR)

US ECCN: 1A995.b

13.17 Wireless Approvals

Approved and registered for use in the following countries/regions:

Algeria*, Australia, Bahrain, Brazil, Brunei, China, Egypt*, India*, Indonesia, Iraq*, Israel, Japan*, Kazakhstan*, Korea, Kuwait, Malaysia, Mexico, New Zealand, Oman, Pakistan*, Philippines*, Qatar, Russia*, Saudi Arabia, Singapore, South Africa*, Taiwan, Thailand, UAE, Uzbekistan*, Vietnam*

*check with Honeywell for availability

13.18 Bluetooth®

Certified and registered Bluetooth SIG.

14 Ordering Information

Part Number	Description
INSTRUMENTS	
SZSK-SMGXX	Searchzone Sonik Ultrasonic Gas Leak Detector, ATEX/IECEX, M25, Stainless Steel, includes Sunshade (Plastic) and Standard Adjustable Mounting Bracket
SZSK-SNGXX	Searchzone Sonik Ultrasonic Gas Leak Detector, cULus, 3/4" NPT, Stainless Steel, includes Sunshade (Plastic) and Standard Adjustable Mounting Bracket
ACCESSORIES	
2331B1102	Pole Mount Kit for Standard Adjustable Mounting Bracket
2331B1020	Large Adjustable Mounting Bracket Plate
2331B1112	Pole Mount Kit for Large Adjustable Mounting Bracket
2331B1131	Stainless Steel Sunshade
SPARES	
2331B1100	Spare Standard Adjustable Mounting Bracket Plate
2331B1130	Spare Standard Sunshade (Plastic)
2331B1150	Spare Terminal Block Set (5 Pack)
2331B1160	Spare Antenna Cover (5 Pack)

15 Specifications

15.1 Short Form Table

Specifications	
Environmental	-55°C to +75°C (-67°F to +167°F); 0 % to 100 % RH condensing
Power Supply	24 Vdc nominal (18 Vdc to 32 Vdc)
Power Consumption	4 W for ambient operating temperature \geq -30°C 15 W for ambient operating temperature $<$ -30°C (heater is active)
Output Signals	4-20 mA with HART, Fault relay, Alarm 1 relay, Alarm 2 relay, Modbus, Bluetooth® (range up to 15 m, depends on mobile device and environmental conditions)
Response Time	Sensor response 1 s; Programmable Verification time from 1 to 600 s
Relay Outputs	Max. 32 Vdc/ac, max. 2 A resistive load
Range of Detection	18 kHz to 70 kHz; 40 dB to 140 dB
Cone of Detection	Typically 20 m on-axis radius (background noise dependent); +/- 90 degrees solid angle from on axis to 6 dB down
Storage Temperature Range	-55°C to +75°C (-67°F to +167°F)
Internal Battery Cell	TLH-2450, 10-year lifetime (replaced only by authorized service)
Weight	Searchzone Sonik: 6.1 kg (13.5 lbs) Standard Adjustable Mounting Bracket: 2.9 kg (6.4 lbs) Stainless Steel Large Adjustable Mounting Bracket: 3.5 kg (7.7 lbs) Stainless Steel
Dimensions	Searchzone Sonik: 103 mm dia x 235 mm x 179 mm Standard Adjustable Mounting Bracket: 165 mm x 165 mm x 127 mm Large Adjustable Mounting Bracket: 210 mm x 210 mm x 127 mm
Ingress Protection	IP 66 / 67 (Type 4X, in accordance with NEMA 250) Resistance to salt mist and sulphuric atmosphere (15-60 minutes exposure to salt air/mist; 15-60 minutes to sulphuric atmosphere)
Accessories	Large Adjustable Mounting Bracket Stainless Steel Sunshade Hazardous Area Mobile Phone Searchzone Sonik App
Compliance to Standards	Core Approvals: EN 50270: (EMC) IEC/EN 61000-6-4; Radio Equipment Directive 2014/53/EU IEC/EN/UL/CSA 61010 (Electrical Safety) FCC / IC RoHS, China RoHS
Safety Approvals	ATEX: II 2 GD DEMKO 18 ATEX 1866 X Ex db ia IIC T4 Gb (for flameproof Ex d installations) Ex db eb ia IIC T4 Gb (for increased safety Ex e installations) Ex tb IIIC T100°C Db Tamb -55°C to +75°C (-67°F to +167°F) Um = 250 Vrms

Specifications	
Safety Approvals	<p>cULus:</p> <p>Class I, Division 1, Groups. B,C,D, T4, Ta -55°C to +75°C (-67°F to 167°F)</p> <p>Class II, Division 1, Groups. E,F,G, T4, Ta -55°C to +55°C (-67°F to 131°F)</p> <p>Class III Div. 1</p> <p>Class I Zone 1 AEx db ia IIC T4 Gb, Ta -55°C to +75°C (-67°F to 167°F)</p> <p>Class I Zone 1 AEx db eb ia IIC T4 Gb, Ta -55°C to +75°C (-67°F to 167°F)</p> <p>Zone 21 AEx tb IIIC T100°C Db, Ta -55°C to +55°C (-67°F to 131°F)</p> <p>Um = 250 Vrms</p> <p>IECEX:</p> <p>IECEX ULD 18.0016X</p> <p>Ex db ia IIC T4 Gb (for flameproof Ex d installations)</p> <p>Ex db eb ia IIC T4 Gb (for increased safety Ex e installations)</p> <p>Ex tb IIIC 100°C Db</p> <p>Tamb -55°C to +75°C (-67°F to 167°F)</p> <p>Um = 250 Vrms</p>

Find out more

www.honeywellanalytics.com

Contact Honeywell Analytics:

Europe, Middle East, Africa, India

Life Safety Distribution GmbH
Javastrasse 2
8604 Hegnau
Switzerland
Tel: +41 (0)44 943 4300
Fax: +41 (0)44 943 4398
India Tel: +91 124 4752700
gasdetection@honeywell.com

Americas

Honeywell Analytics Inc.
405 Barclay Blvd.
Lincolnshire, IL 60069
USA
Tel: +1 847 955 8200
Toll free: +1 800 538 0363
Fax: +1 847 955 8210
detectgas@honeywell.com

Asia Pacific

Honeywell Analytics Asia Pacific
7F SangAm IT Tower, 434 Worldcup Buk-ro,
Mapo-gu, Seoul 03922
Korea
Tel: +82-2-69090300
Fax: +82-2-69090328
analytics.ap@honeywell.com

Technical Services

EMEA: HAexpert@honeywell.com
US: HA.us.service@honeywell.com

Honeywell

THE POWER OF **CONNECTED**

Please Note:

While every effort has been made to ensure accuracy in this publication, no responsibility can be accepted for errors or omissions. Data may change, as well as legislation and you are strongly advised to obtain copies of the most recently issued regulations, standards and guidelines. This publication is not intended to form the basis of a contract.

11/2018
2331M1220 Issue 1
© 2018 Honeywell Analytics