



blacklinesafety

EX08

Technical User Manual

Contents

1	OVERVIEW	8
2	HARDWARE	8
2.1	EXO 8 CONFIGURATIONS	9
2.1.1	Pump.....	9
2.1.2	Diffusion.....	9
2.2	EXO 8 GAMMA.....	10
2.3	WHAT'S IN THE BOX.....	10
2.4	LIGHT AND SOUND PATTERNS.....	11
3	COMMUNICATION	12
3.1	BLACKLINE SAFETY SYSTEM ACCESS.....	12
3.1.1	Blackline Live.....	12
3.1.2	Blackline Analytics.....	12
3.2	OPTIONAL SERVICES.....	12
3.2.1	Blackline Safety Monitoring.....	12
3.3	COMMUNICATION INTERVALS.....	13
3.4	CONNECTION MODULES	13
3.4.1	Cellular Connection Module.....	13
3.4.2	Satellite Connection Module	13
3.4.3	Determining if a Satellite Module is Installed.....	14
4	CARTRIDGES.....	14
4.1	CARTRIDGE OPTIONS	14
4.2	CHANGING CARTRIDGES.....	15
4.3	SENSOR CONTAMINANTS	15
4.4	CARTRIDGES AND EXTREME WEATHER.....	15
5	SETUP	16
5.1	LOCATION.....	16
5.1.1	Determining Location	17
5.2	MOUNTING.....	17

- 5.2.1 Mounting Point Layout 19
- 5.3 SETUP WIZARD.....20
- 5.4 CONNECTIVITY LIGHT21
- 6 OPERATION 22**
- 6.1 EXO 8 PUSH BUTTONS.....22
- 6.2 POWERING ON EXO 8.....23
 - 6.2.1 Powering Off EXO 8 24
- 6.3 EXO 8 DUAL LCD DISPLAY.....25
 - 6.3.1 Home Screen 25
 - 6.3.2 Live Readings Screen 26
 - 6.3.3 Main Menu..... 27
 - 6.3.4 Banner 28
- 6.4 EXO 8 BATTERY 29
 - 6.4.1 Battery Life 29
 - 6.4.2 Battery Storage..... 29
 - 6.4.3 Battery Gauge 30
- 6.5 CHARGING EXO 8..... 30
 - 6.5.1 Using the Quick Charger 30
 - 6.5.2 Trickle Charger..... 32
- 6.6 MAINTENANCE CODE 32
- 6.7 ALARM TEST 33
- 6.8 SIREN 34
- 6.9 SPEAKER 34
- 7 OPERATIONAL NOTIFICATIONS 35**
- 7.1 ACKNOWLEDGING OPERATIONAL NOTIFICATIONS.....35
- 7.2 OPERATIONAL NOTIFICATION TYPES35
- 8 LOW URGENCY NOTIFICATIONS..... 37**
- 8.1 ACKNOWLEDGING LOW URGENCY NOTIFICATIONS38
- 8.2 LOW URGENCY NOTIFICATION TYPES.....38
- 9 HIGH URGENCY NOTIFICATIONS 42**
- 9.1 ACKNOWLEDGING HIGH URGENCY NOTIFICATIONS42

9.2	HIGH URGENCY NOTIFICATION TYPES.....	42
9.3	LIVE RESPONSE.....	46
10	GAS AND GAMMA DETECTION	46
10.1	VIEWING AND RESETTING GAS READINGS.....	46
10.2	VIEWING AND RESETTING GAMMA READINGS.....	47
10.3	BUMP TEST.....	49
10.3.1	Manual Bump Test.....	50
10.4	CALIBRATION.....	53
10.4.1	Manual Calibration.....	54
10.5	AUTOMATIC BUMP TESTS AND CALIBRATIONS.....	57
10.6	ZERO SENSORS.....	58
10.6.1	Manual Zero Sensors.....	58
10.7	LEL SENSOR PRECAUTIONS.....	60
10.8	PID TARGET GASES.....	62
10.9	GAS ALERT COUNTDOWN.....	63
11	GAS INLETS.....	64
11.1	MANUAL CALIBRATION INLET.....	64
11.2	PUMP INLETS.....	65
11.3	GAS SAMPLING.....	66
11.4	PUMP BLOCKED.....	67
12	FEATURES.....	69
12.1	TEXT MESSAGES.....	69
12.2	TWO-WAY VOICE CALLS.....	72
12.3	PUSH-TO-TALK (PTT).....	73
12.4	AVAILABLE CHANNELS.....	73
12.4.1	Changing Channels.....	74
12.5	AIRPLANE MODE.....	76
12.6	STEALTH.....	77
12.7	LOCAL TIME.....	77
12.8	TIMER.....	80
12.9	STOPWATCH.....	82

- 13 DEVICE SETTINGS 84
 - 13.1 LANGUAGES MENU85
 - 13.2 SIREN VOLUME MENU.....86
 - 13.3 PUMP OPTIONS MENU.....86
 - 13.3.1 Configuring Tube Length..... 86
- 14 ADVANCED INFO MENU 88
 - 14.1 DEVICE INFO.....88
 - 14.2 GPS LOCATION.....89
 - 14.3 BEACONS.....90
 - 14.4 COMM INFO91
 - 14.5 AIRPLANE MODE.....92
- 15 ELECTRICAL PORTS..... 93
 - 15.1 CAUTIONS.....93
 - 15.2 DEFINITIONS.....93
 - 15.3 EXO 8 TRANSLATOR.....95
 - 15.4 POWER PORT95
 - 15.4.1 Installing Accessories96
 - 15.5 A/B INTERFACE PORTS.....97
 - 15.5.1 Installing Accessories98
- 16 OVER-THE-AIR FIRMWARE UPDATES 102
- 17 SUPPORT 103
 - 17.1 LEARN MORE..... 103
 - 17.2 TECHNICAL SUPPORT..... 103
- 18 SPECIFICATIONS..... 104
 - 18.1 DETAILED SPECIFICATIONS 104
- 19 LEGAL NOTICES AND CERTIFICATIONS 106
 - 19.1 LEGAL NOTICES..... 106
 - 19.2 INTRINSICALLY SAFE CERTIFICATION 107
 - 19.3 INMETRO CERTIFICATION..... 108
 - 19.4 LEL FUNCTIONAL SAFETY..... 109

WARNINGS

- ▲ **WARNING:** Remove EXO's battery in a known safe environment with a clean atmosphere that is free of explosive gas.
- ▲ **WARNING:** EXO quick charger is NOT intrinsically safe. It should only be used in a safe environment with a clean atmosphere.
- ▲ **WARNING:** DO NOT allow metal tools or personal items to touch the battery terminals. Touching metal or any conductive material to the battery terminals is extremely dangerous and will damage the battery.
- ▲ **WARNING:** An attached trickle charger is ONLY intrinsically safe when connected as described in the electrical diagrams in section 13.
- ▲ **WARNING:** Listening to EXO's siren at high volume for extended periods of time can cause permanent hearing loss. Adjust EXO's siren volume for use indoors and in smaller spaces. Wear appropriate ear protection during testing.
- ▲ **WARNING:** Do NOT power off EXO if the blue LiveResponse light is on.
- ▲ **WARNING:** You must zero EXO's sensors with clean air. If a sensor is zeroed where its targeted gas levels are abnormal, the gas levels EXO displays will not be accurate. Inaccurate readings are a safety hazard.
- ▲ **WARNING:** Off-scale (overlimit) readings may indicate an explosive concentration.
- ▲ **WARNING:** Calibrations must only be performed in areas free of flammable gases.
- ▲ **WARNING:** Gas notifications are NOT generated during a purge.
- ▲ **WARNING:** The EXO 8 Pump configuration is not compatible with the following gases: Chlorine (Cl₂), Chlorine Dioxide (ClO₂), Hydrogen Cyanide (HCN), Hydrogen Fluoride (HF), and Ozone (O₃).
- ▲ **WARNING:** If you start the pump while operating at temperatures of -20°C (-4°F) or lower, EXO generates a pump blocked alarm (see section 11.4) that persists until the inlet warms up and begins operating normally. In a multiple inlet sampling cycle, the inlets do not have time to warm up. For temperatures below -20°C (-4°F), use only single-gas sampling.
- ▲ **WARNING:** Cables attached to the power port are only intrinsically safe when properly set up with an electrical barrier.
- ▲ **WARNING:** EXO does NOT monitor when firmware is installing.
- ▲ **WARNING:** When airplane mode is on, you cannot use the SOS latch or otherwise call for help using EXO.

blacklinesafety

- ▲ **WARNING:** When Stealth is enabled, the lights do not flash, the siren does not sound, and EXO does not indicate incoming voice calls. Blackline Safety recommends that you have an alternative channel of communication available when EXO is in Stealth.
- ▲ **WARNING:** Remove EXO's battery in a known safe environment with a clean atmosphere that is free of explosive gas.
- ▲ **WARNING:** EXO quick charger is NOT intrinsically safe. It should only be used in a safe environment with a clean atmosphere.

1 OVERVIEW

EXO 8 is Blackline Safety's cloud-connected area monitor. EXO continuously measures gas and gamma concentrations in the ambient environment at sites, facilities, and fence lines, and activates notifications when concentrations of toxic and combustible gases exceed configured setpoints.

In the event of a safety incident or gas exposure, monitoring personnel can see what has happened and communicate with workers directly through EXO via text messaging or an optional two-way voice calling feature.



2 HARDWARE

Blackline Safety offers two versions of EXO: EXO 8 (EX8N) and EXO 8 Gamma (EX8G). Each version is available in multiple configurations, allowing you to select the one that best meets your organization's needs. The configurations can modify the device's operation mode, expand the sensor capacity, and are designed for easy field installation.

EXO 8 is available in the following configurations:

- Pump
- Diffusion
- Gas expansion module

The optional gas expansion module enables EXO to detect up to four additional gases. The module can be installed with both Diffusion and Pump configurations. When installed in a device with the Diffusion configuration, the module converts the device to pumped. The gas expansion module will be available in 2025.

2.1 EXO 8 CONFIGURATIONS

2.1.1 PUMP

The EXO Pump configuration can be used to remotely sample up to four confined spaces or locations. EXO Pump has four pump inlets and uses internal pumps and external tubes to sample air from remote areas. EXO Pump also has a manual calibration inlet that requires a fixed-flow regulator to function correctly.



2.1.2 DIFFUSION

The EXO Diffusion configuration helps you effectively monitor and measure ambient gas concentrations. EXO Diffusion has a manual calibration inlet that requires a fixed-flow regulator to function correctly.



Wind Guard

When bump testing or calibrating EXO Diffusion in windy conditions, you must use the wind guard to help regulate the flow and concentration of gas delivered to the sensors.

To use the Wind Guard:

1. Position the Wind Guard in front of EXO with the narrow ends on top.
 2. Slide the Wind Guard into the front air diffusion vents (underneath the top lights). When the Wind Guard is in the proper position, the two clamps lock.
 3. Bump test or calibrate as usual.
 4. When bump test or calibration is complete, remove the Wind Guard and store it in a clean, dry environment for later use.
- ▲ **WARNING:** You MUST remove the Wind Guard when the bump test or calibration is complete. Failure to remove the Wind Guard slows down EXO's response to hazardous gases.



2.2 EXO 8 GAMMA

EXO 8 Gamma is equipped with a factory-installed gamma radiation sensor, which is compatible with both the pump and diffusion configurations. When the gamma sensor is installed, EXO 8 continuously measures both gas and gamma radiation concentrations in your environment.

NOTE: As the gamma radiation sensor is factory-installed, it cannot be installed at a later time.

2.3 WHAT'S IN THE BOX

EXO comes with the following components:

- EXO device
- 1m (3 ft) of tube fitted with a quick-connect coupling insert
- Quick charger with battery pack hex key
- Multi-gas cartridge
- Pre-installed cellular connection module
- Optional pre-installed satellite connection module
- Certification and support card

2.4 LIGHT AND SOUND PATTERNS

Event/Mode	Light Patterns	Sound Patterns
Operation		
Device Off	None	None
Firmware Updates		
Power On	Blinking green connectivity light when trying to connect to Blackline Live Solid green connectivity light when connected to Blackline Live	None
Start-up Sequence	Alternating flashing red and yellow lights	Single beep
Low Battery	Alternating flashing yellow lights	Repeating beep pattern
Shutdown Sequence	Two flashes of yellow lights	Single beep
Compliance and Modes		
Calibrations	Simultaneous double flashing yellow lights	Double beep when starting and completing a calibration
Normal Mode	Solid green connectivity light when connected to Blackline Live	None
Secondary Modes	Simultaneous double flashing yellow lights every 30 seconds	Double beep when entering and exiting a secondary mode
Low urgency Notifications		
Incoming Message	Rapid alternating flashing yellow lights	Repeating beep pattern
Two-way Voice Call		
Low Gas		
Pump Blocked		
Tumble		
AlertLink		
Sensor Error	Rapid alternating flashing yellow lights	Repeating beep pattern
Sensor Under Limit		
Device Self Test (Memory and Flash) Error		
High urgency Notifications		
High Gas	Rapid alternating flashing red lights	Repeating beep pattern
Over Limit (OL)		
SOS Alert		
LEL > 60%	Rapid alternating flashing red lights	Repeating beep pattern
LEL Over Limit		
Gas Alert Muted	Rapid alternating red lights	None

3 COMMUNICATION

3.1 BLACKLINE SAFETY SYSTEM ACCESS

EXO comes with basic system access, which allows EXO to connect to Blackline Live.

3.1.1 BLACKLINE LIVE

Blackline Live monitors your Blackline Safety devices and contains reports and, depending on your plan, business analytics insights. Blackline Live is where you can create and customize configuration profiles that determine how a device, or a group of devices, operates in the field. For more information, please see [Blackline Live](#).

3.1.2 BLACKLINE ANALYTICS

Blackline Analytics is where you can review data collected from your device fleet to make operational decisions, follow up with your team, and ensure everything is running smoothly. Blackline Analytics provides a variety of pre-defined reports and filters to help you explore your data. For more information, please see [Blackline Analytics](#).

3.2 OPTIONAL SERVICES

There are various service plans and add-ons available to suit your organization's needs, such as Blackline or self-monitoring, Push-to-Talk, and two-way voice calls. For more information, see section 12 or contact your Customer Relationship Manager (CRM).

3.2.1 BLACKLINE SAFETY MONITORING

Depending on your needs and requirements, various service plan options are available for EXO, including 24/7 live safety monitoring by Blackline Safety. Contact your organization's safety professional for more information regarding the details of your service plan. For more information, please see [Blackline 24/7 Live Monitoring](#).

3.3 COMMUNICATION INTERVALS

The following table describes the default communication frequency to Blackline Live for each connection module:

	Normal Operation	When EXO is in Motion	During a High-Urgency Event
Cellular	30 min	30 seconds	Immediately
Satellite	2 hrs	30 mins	Immediately

NOTE: If your configuration profile has Gas Alert Countdown enabled, communication to monitoring personnel is delayed by 30 seconds during high-urgency gas events.

3.4 CONNECTION MODULES

A connection module links EXO to Blackline Live using a cellular network or the Iridium satellite network.

EXO first tries to connect to Blackline Live with the built-in cellular connection module. If cellular coverage is not available and an optional satellite connection module is installed, EXO tries to connect to Blackline Live through the Iridium satellite network. See sections 5.4 and 6.3 for more information on connectivity.

3.4.1 CELLULAR CONNECTION MODULE

This module works with 2G/4G networks in Europe, and 3G/4G networks in North America to connect EXO to Blackline Live. Cellular series are available in over 100 countries, supporting over 200 cellular networks. This module is built into every EXO.

3.4.2 SATELLITE CONNECTION MODULE

When EXO is not in an area with cellular coverage, this module works with the Iridium satellite network to connect EXO to Blackline Live. You can order this module for pre-install in EXO, or you can purchase it as an upgrade for EXO devices in the field. For installation instructions, please see [EXO Satellite Installation Guide](#).

NOTE: Two-way voice capabilities and push-to-talk (PTT) are not available when connected via satellite.

NOTE: You may experience a reduction in data collection while using the satellite module.

You can tell which connection type EXO is using by the connectivity icon displayed on EXO's main screen. See section 4.3 for more information about connectivity icons.

3.4.3 DETERMINING IF A SATELLITE MODULE IS INSTALLED

If you are unsure if EXO has a satellite connection module installed, check the window behind the battery pack.



Figure 3-1: Satellite Connection not Installed



Figure 3-2: Satellite Connection Installed

To find this information from the menu:

1. Using the left and right buttons, scroll, then select Menu by pressing the center button.
2. Select Advanced.
3. Select **Comm info**.

4 CARTRIDGES

4.1 CARTRIDGE OPTIONS

EXO 8 can only use multi-gas (diffusion) cartridges, which can be configured to detect up to four gases, or five gases when using a dual CO and H₂S (COSH) sensor.

NOTE: Blackline Safety cartridges are intrinsically safe. This means you can change EXO's cartridges in potentially hazardous zones.



You can install the optional EXO gas expansion module to detect up to four additional gases. The optional gas expansion module will be available in 2025.

4.2 CHANGING CARTRIDGES

To remove a cartridge:

1. Power off EXO.
2. Unscrew the four cartridge cover screws.

NOTE: These are captive screws and should stay attached to the cartridge cover.

3. Pull forward on the cartridge cover to remove. Set aside.

Pull the cartridge out of the cartridge slot.



To insert a cartridge:

1. Orient the cartridge so that the sensors are facing down.
2. Push the cartridge into the cartridge slot.
3. Replace the cartridge cover.
4. Tighten the screws.

NOTE: The screws should be snug but not overtightened.

4.3 SENSOR CONTAMINANTS

Gas sensors are susceptible to contamination by a variety of common chemicals, reducing or eliminating their effectiveness.

For details on preventing sensor contamination, see [Cleaning Devices and Accessories](#).

4.4 CARTRIDGES AND EXTREME WEATHER

EXO operates optimally in the range of -20°C to 50°C (-4°F to 122°F). For best practices operating EXO outside that range, see [Operating Devices in Extreme Weather](#).

Electrochemical sensors

At temperatures below -20°C (-4°F), the sensor electrolyte inside CO, H₂S, and other electrochemical sensors can freeze, reducing the ability of the sensor to give a meaningful output. Storing EXO in a warm and humid (50% relative humidity) environment when not in use, helps keep electrochemical sensors running longer.

Shocking an electrochemical sensor from room temperature to extreme cold and vice versa can also cause temporary drifts in sensor readings. These readings typically resolve in less than 60 seconds.

Infrared (IR) LEL sensors

Sudden temperature and humidity changes may cause condensation within the LEL-IR sensor, which can affect its optics and trigger a temporary baseline drift. Typically, these readings last less than 60 seconds, after which point the readings recover and EXO functions as normal.

Shocking the IR sensor from room temperature to an extremely cold environment can cause a temporary baseline drift, typically less than 10% LEL. If this drift persists, you can manually zero the sensor in the cold environment.

Shocking the IR sensor from an extremely cold environment to room temperature can cause a temporary baseline drift, sometimes reaching overlimit.

5 SETUP

5.1 LOCATION

EXO 8's location is determined through satellite-based positioning or by scanning for Blackline Location Beacons.

NOTE: Although a defined location helps emergency response teams know where to respond, EXO does not need a determined location to function as a safety monitor or gas detector.

Satellite-based positioning (GPS)

EXO can use GPS, QZSS, Galileo, and BeiDou satellite constellations to determine its location. Satellite-based positioning works best when the area monitor is outside with a clear view of the sky. If EXO is within a Location Beacon's signal radius and satellite-based positioning is also available, the one with the strongest signal is used.

Location Beacons

When within a beacon's signal radius, EXO sees the beacon and sends the beacon's ID to Blackline Live. EXO's location is recorded as the beacon's pre-defined location. If EXO sees multiple beacons, it associates itself with the beacon with the strongest signal. If beacons and satellite-based positioning are both available, the one with the strongest signal is used. You can configure this in Blackline Live. Contact your organization's factory personnel for more information regarding configurations.

5.1.1 DETERMINING LOCATION

EXO performs best when placed strategically within the area you wish to monitor. When placing EXO, consider the following:

Positioning

- Keep EXO upright.
- Keep EXO accessible for regular interactions like bump tests and messages.
- Do not hang EXO by its handle. For hanging instructions, see the [EXO Hanging Mount Guide](#).

Environment

- Keep EXO's electrical ports and gas inlets covered when not in use.
- Do not place EXO in water.
- Consider wind direction and air flow.

Connectivity

- If connecting to Blackline Live through a satellite network, EXO must be placed outdoors with a clear view of the sky.
- If connecting to Blackline Live through a cellular network, EXO may struggle to find connection indoors or in areas of weaker cellular reception.

5.2 MOUNTING

EXO's base is fitted with a mounting plate with two sizes of threaded mounting points. The use of mounting points is not required to mount EXO. Select the appropriate mounting points for your application.

Type A Mounting Point

A single mounting point threaded 5/8 in to 11 UNC with a maximum depth of 3/4 in or 19 mm.

Type B Mounting Point

Five mounting points that are M6 threaded with a maximum depth of 5/8 in or 16 mm.

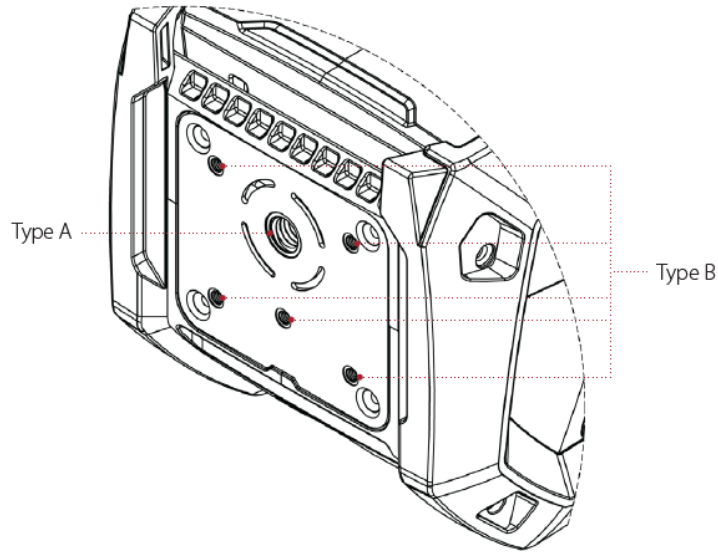

5.2.1 MOUNTING POINT LAYOUT

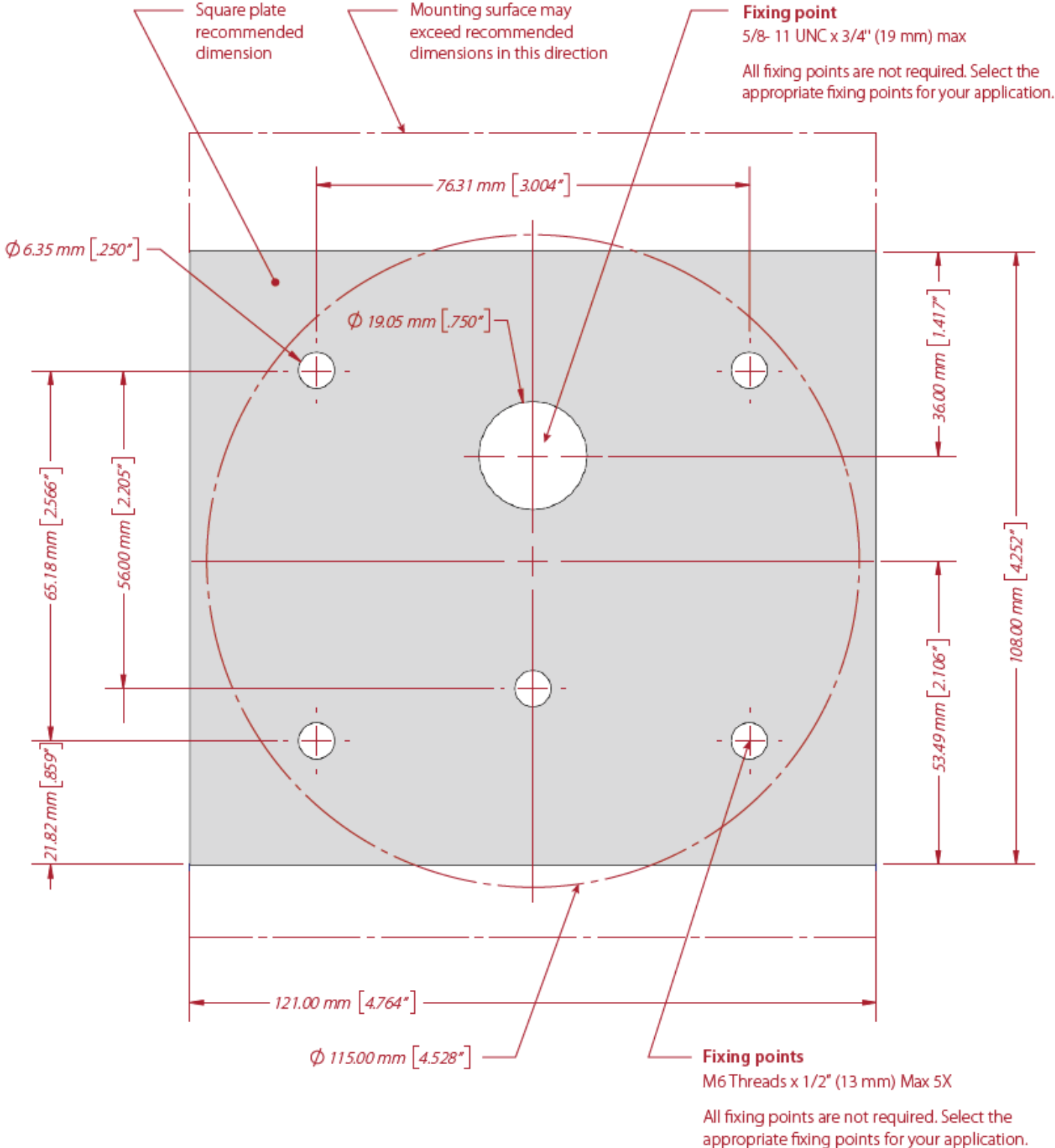

5.3 SETUP WIZARD

The setup wizard is an optional test that lets you know if EXO is operating correctly and fully. It establishes that EXO can determine its location, can connect to Blackline Live, and is vertical.

EXO continues to monitor for gas in the area during the setup wizard test. Low-urgency notifications, an SOS latch pull, or dangerous gas levels override the setup wizard.

To run setup from start-up:

1. Power on EXO.

EXO goes through the start-up sequence.

2. At the end of the start-up sequence, a prompt to start the setup wizard displays on the screen.

If no selection is made after 15 seconds, the prompt screen times out and EXO automatically goes to the main gas detection screen without running the setup wizard.

If you run the setup wizard, EXO performs the setup automatically. This should only take a few minutes.



To run from the Main menu:

1. Open the Main menu.

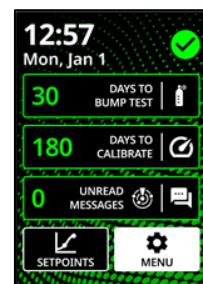

2. Select **Setup wizard**. EXO performs the setup automatically.

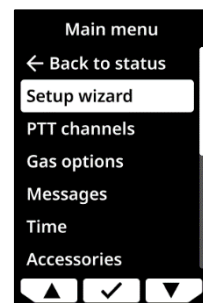

If setup wizard is successful:

EXO emits a success sound and the screen displays “ready for use.”

1. Select ✓ to go to the main gas detection screen.

If setup wizard is unsuccessful:

EXO emits a failure sound. One of the following three reasons for the failure displays on the screen with a red X:

- EXO could not determine its location.
- EXO could not connect to Blackline Live.
- EXO is not vertical.

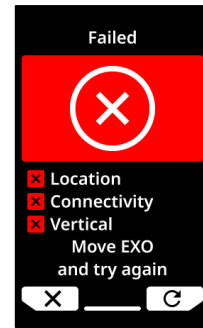

Address each item on the list, then select ↻ to run the setup wizard again.

Select ✗ to skip the setup wizard and go to the main gas detection screen.

5.4 CONNECTIVITY LIGHT

EXO lets you know its connection status through the green connectivity light.

Blinking green light

A blinking connectivity light indicates EXO is trying to connect to Blackline Live. EXO continues to monitor the area, although monitoring personnel cannot receive communications while the light is blinking. Data collected by EXO while the green connectivity light is blinking is sent when EXO connects to Blackline Live. This includes low-urgency and high-urgency notifications, location, messages, etc. For more information, see [Understanding Offline Data Storage For G7 Devices](#).

Solid green light

A solid connectivity light indicates EXO is connected to Blackline Live and data collected by EXO is being or has been transmitted to Blackline Live. Monitoring personnel receive and respond to high-urgency notifications while this light is solid.

Connection lost

If EXO loses connection to Blackline Live, an operational notification is triggered after a configurable length of time. If EXO reconnects to Blackline Live within this time limit, no notification is triggered.

See sections 3.4 and 6.3 for more information on connectivity.

6 OPERATION

6.1 EXO 8 PUSH BUTTONS

Interacting with EXO 8 is easy with its high-visibility, backlit dual LCD display, three-button menu system, and SOS latch.



Power button

Press the power button to power EXO on or off.



Center button

Press the center button to confirm a menu selection.



Left and right buttons

Use the left and right buttons to navigate options. Press and hold both buttons simultaneously to acknowledge and mute a low-urgency or high-urgency notification.



SOS latch pull

Pull the SOS latch to call for help when emergency assistance is required. See section 9.2 for more information.



Latch push (optional)

Push and hold the SOS latch to record a push-to-talk (PTT) message. Release the latch to send the message to devices on the same channel. See section 12.3 for more information.

6.2 POWERING ON EXO 8

Powering on EXO initiates the device's start-up sequence.

To power on EXO:

1. Press and hold the power button for two seconds.
2. EXO performs a hardware self-test of lights and sounds.

NOTE: Your device only displays the firmware successfully updated screen during the power-on sequence if your device restarted due to a firmware installation.

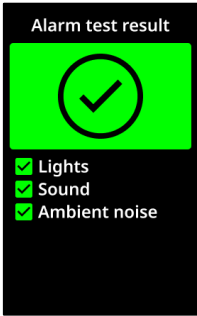

The screen displays the active features on EXO.

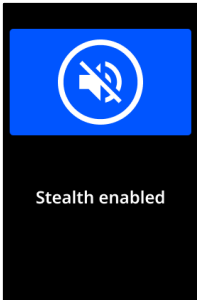

EXO displays the gas and gamma setpoints for all sensors that are configured on the device.

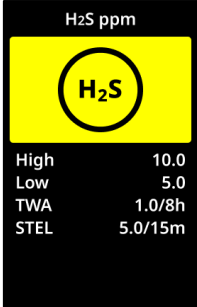

If bump test and calibration reminders are configured in Blackline Live, EXO indicates when the next bump tests and calibrations are due.

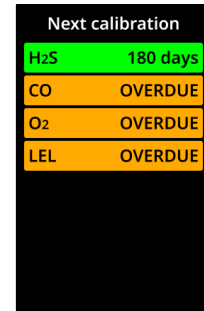

If EXO is configured to zero on start-up, your device indicates if the operation was successful. If the zero was unsuccessful, manually zero the device.

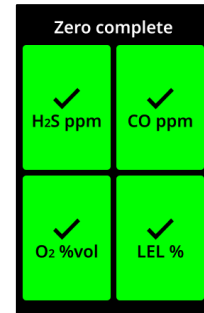

- At the end of the start-up sequence, a prompt to start the setup wizard displays on the screen.

EXO has finished its start-up sequence when it completes the following:

- EXO sounds a chime, signaling it is powering on.
- The top lights flash.
- The green connectivity light stops flashing and becomes solid, indicating EXO is connected to Blackline Live.



NOTE: If you see an **O₂ stabilizing** message on EXO's screen, it means EXO is not monitoring. Stabilization takes approximately 10 seconds. However, if EXO has been powered off for a significant period, it can take up to 20 minutes for the O₂ sensor to stabilize. If this message persists, contact your organization's safety professional.

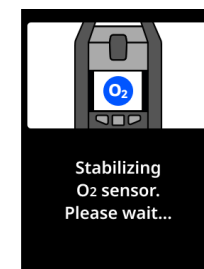

6.2.1 POWERING OFF EXO 8

NOTE: If the maintenance code is enabled, you must input the correct code to unlock EXO before powering off. See section 6.6 for more information about the maintenance code.

To power off EXO:

1. Press and hold the power button for three seconds. EXO has finished powering off when it completes the following:
 - EXO sounds a chime signaling it is powering off.
 - The screen goes into EXO's shutdown sequence.
 - When the lights and sounds have stopped, EXO is powered off and disconnected from Blackline Live.

NOTE: Make sure you resolve high-urgency notifications before you power off EXO. Do NOT power off EXO if the blue LiveResponse light is on. This may mean waiting for monitoring personnel to contact you through EXO. See section 99 for more information on high-urgency notifications.

6.3 EXO 8 DUAL LCD DISPLAY

6.3.1 HOME SCREEN

The Home screen shows the live gas readings, current device (event) status, and information about the type of event (if present) through screen status and banner messages.

You can use the cards on the Home screen as shortcuts to complete bump tests and calibrations, view unread messages, view set points, or open the Main menu. Use the left and right buttons to navigate through the cards, then press the center button to select a card.

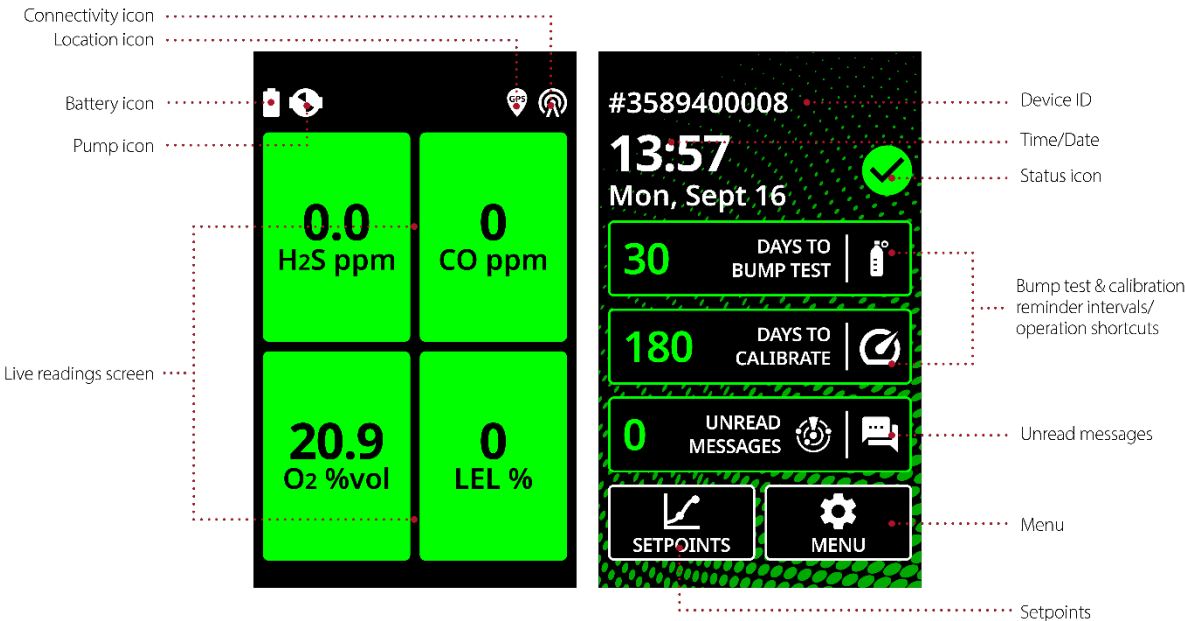

EXO 8 has three Home screen statuses:

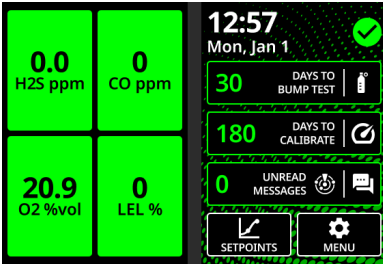

OK status

EXO has no active notifications that require your attention.

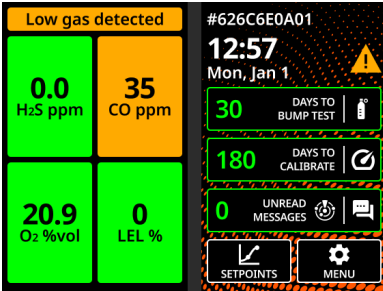

Low urgency status

EXO has active low-urgency or operational notifications that require your attention. Monitor the banner for more information.

For more information on EXO low-urgency and operational notifications, see sections 7 and 8.

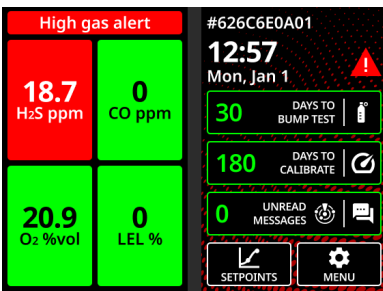

High urgency status

EXO has active high-urgency notifications that require your immediate attention/interaction. Monitor the banner for more information.

For more information on EXO high-urgency notifications, see section 9.

6.3.2 LIVE READINGS SCREEN

EXO's left LCD screen is the Live readings screen. EXO's multi-gas cartridge sensor configuration determines the layout of this screen.

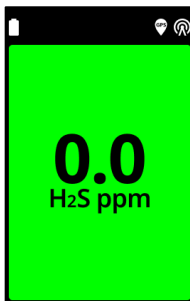

One gas

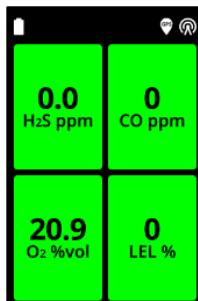

Four gases and gamma

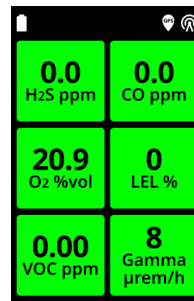

Five gases and gamma

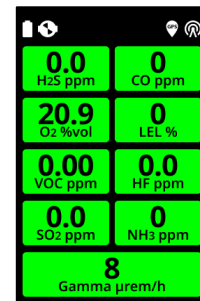

Eight gases and gamma

The Live readings screen displays live gas and gamma readings for each sensor. Each sensor reading card remains green when the device is in a normal operating state.

The gas reading cards change to yellow when a low-urgency notification is activated or change to red when a high-urgency notification is activated.

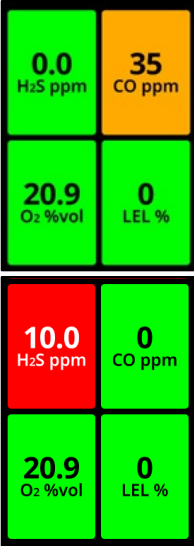

The gas card changes to white during bump tests and calibrations to indicate that gas events are paused for the duration of the operation.

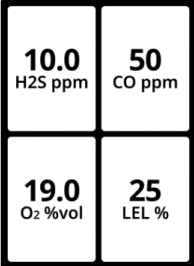

6.3.3 MAIN MENU

The Main menu contains additional features and device information available to EXO 8 users.

To launch the Main menu:

- 1. If no cards are highlighted on the Home screen, press the center button to open the Main menu.
You can also use the left and right buttons to scroll, then select **Menu** by pressing the center button.









6.3.4 BANNER

The banner at the top of the Home screen provides more information about low-urgency and high-urgency notifications, battery life, location, and connectivity.

NOTE: If EXO has more than one notification simultaneously active, the banner cycles through each event.

Battery life icon



The battery icon in the top bar of the screen shows how much charge the battery has. See section 6.4 for more information regarding the battery pack.

	Battery charging
	81% to 100%
	61% to 80%
	41% to 60%
	21% to 40%
	1% to 20%
	Low battery

NOTE: By default, the banner displays a “Low battery” message, and the battery icon becomes red when the battery’s power drops below 10%. You can configure this threshold in Blackline Live.

Location icon

Only one location icon displays at a time. See section 5.1 for more information.

	Beacon Displays when a beacon signal is present
	Satellite positioning (GPS) Displays when no beacon signal is present and satellite positioning is possible
	None Displays when there are no beacon signals and satellite positioning is not possible

Connectivity icon

Only one connectivity icon is displayed at a time. See sections 3.4 and 5.4 for more information about connectivity.



Cellular

Displayed when EXO is connected to Blackline Live through a cellular network



Satellite

Displayed when EXO is connected to Blackline Live through satellite



None

Displayed when EXO is NOT connected to Blackline Live

6.4 EXO 8 BATTERY

EXO devices are shipped with a pre-installed battery pack and a quick charger.

6.4.1 BATTERY LIFE

The standard battery pack can power EXO for over 100 days, and the lightweight version for over 50 days. Battery life varies depending on device configurations, low urgency and high-urgency notification response, operating temperature, sensor types, and pump usage. In operational temperatures below -20°C (-4°F), the battery pack's runtime drops significantly. See section 4.4 for more information about running EXO in cold temperatures.







6.4.2 BATTERY STORAGE

For long-term storage, Blackline recommends storing the battery at 20°C (68°F).

6.4.3 BATTERY GAUGE

Press and hold the battery gauge button on the battery pack to show the remaining battery charge.

NOTE: A dimmed bar indicates that the battery is in the lower half of the bar's percentage range.

	5 bars: 85-100%
	4 bars: 65-84%
	3 bars: 45-64%
	2 bars: 25-44%
	1 bar: 5-24%
	1 bar blinking: 0-4%

Battery gauge while charging

The battery gauge automatically lights up and remains lit while the battery pack is charging. The gauge displays the current charge of the battery pack as described previously. When the battery reaches 100%, it stops charging and the gauge's light turns off.

6.5 CHARGING EXO 8

6.5.1 USING THE QUICK CHARGER

EXO quick charger connects directly to EXO 8's battery and charges it overnight.

- ▲ **WARNING:** Remove EXO's battery in a known safe environment with a clean atmosphere that is free of explosive gas.
- ▲ **WARNING:** EXO quick charger is NOT intrinsically safe. It should only be used in a safe environment with a clean atmosphere.
- ▲ **WARNING:** DO NOT allow metal tools or personal items to touch the battery terminals. Touching metal or any conductive material to the battery terminals is extremely dangerous and will damage the battery.

Operating temperature for quick charger

The quick charger's ideal operating temperature is 22°C (72°F) but it can be used between 5°C and 40°C (41°F to 104°F) without any adverse effects.

To remove the battery:

1. Power off EXO.
2. Ensure EXO is in a safe environment with a clean atmosphere.
3. Loosen the two self-retaining screws at the top of the battery on the back of EXO.

NOTE: This requires a 4 mm hex key (included with EXO).

4. Pull the top of the battery away from EXO.

NOTE: When EXO is vertical, the battery leans away from EXO, allowing you to grip and remove the battery.

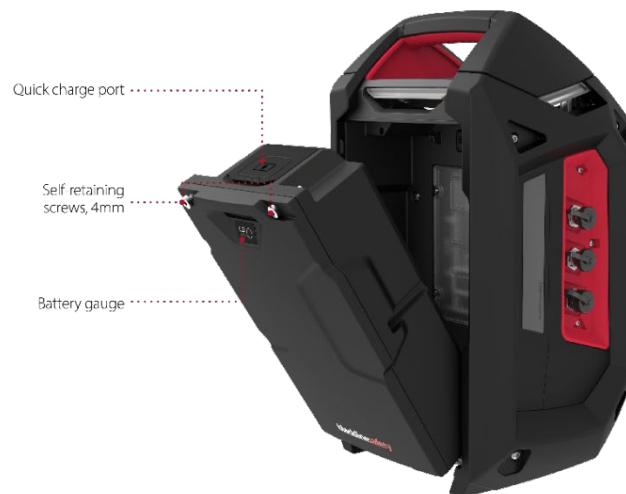

To charge the battery using the quick charger:

1. Lift the rubber flap at the top of the battery pack to expose the charging port.
2. Plug the quick charger into the battery's charging port.
3. Plug the quick charger into an outlet.
4. Turn the charger's power switch on. Charging may take up to 12 hours.

NOTE: The battery pack is fully charged when the red light on the charger turns green.

5. When fully charged, remove the quick charger from the charging port.
6. Replace the rubber flap to cover the charging port.

To insert the battery:

1. Ensure EXO is in a safe environment with a clean atmosphere.
2. Hold the battery at a 45-degree angle with the bottom pointing towards EXO.
3. Place the battery bottom first into EXO's battery slot.
4. Push the top of the battery towards EXO until it sits flush.
5. Tighten the two screws at the top of the battery.

NOTE: The screws should be snug, but not over-tightened.

6.5.2 TRICKLE CHARGER



You may choose to buy an EXO Trickle Charger Kit from Blackline Safety. This kit connects EXO directly to a power source through the power port eliminating the need to power down and remove EXO from the field to charge the battery pack. See section 15.3 for more information about the power port.

⚠ WARNING: An attached trickle charger is ONLY intrinsically safe when connected as described in the electrical diagrams in section 13.

6.6 MAINTENANCE CODE

EXO features an optional maintenance code to prevent unauthorized individuals from changing the settings when the device is unmanned. EXO's entire menu, device power-down, and volume-change actions are locked when a maintenance code is enabled. Entering the code provides access to locked features.

The EXO Configuration profile page in Blackline Live is where you enable the maintenance code and set the four-digit number passcode.



When the device is locked, a lock icon displays in the Gas status screen banner. Pressing any button while EXO is locked displays the Maintenance code entry screen.

To unlock EXO:

1. Press any button to display the Maintenance code entry screen. You are prompted to enter a four-digit number.
2. Use the left and right buttons to select a number for the current digit.
3. Press the center button to move to the next digit.
4. After selecting the final digit, press the center button to enter the code.

If successful, the entered code becomes green, and the Gas status screen opens.

If unsuccessful, the entered code becomes red.

5. You can either select  to enter another code, or  to return to the locked Gas status screen.

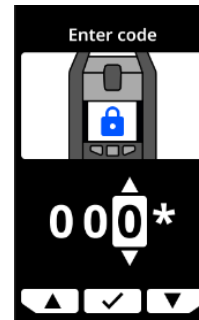

6.7 ALARM TEST

EXO's alarm test is an audio/visual assessment used to ensure the siren, speaker, LED lights, and microphones are operating correctly. The top lights flash and the notification pitch increases. You cannot adjust the volume of alarm test sounds.

An alarm test is run at the following times:

- During the start-up sequence
- Before a bump test
- Before a calibration

If EXO detects a problem while running the alarm test, it immediately tries to run the full test two more times. If EXO still detects a problem after the third try, the failed alarm test results are recorded and sent to Blackline Live.

NOTE: Muffling the speaker during an alarm test results in a failure. The test also fails if the environment is too loud.

6.8 SIREN

The siren is used to inform you of the following:

- Operational notifications
- Low-urgency notifications
- High-urgency notifications
- Sensor errors

For EXO to function effectively as an area gas monitor, the siren must be loud enough to be heard over all environmental noise. EXO's siren volume, measured at 6 in. (152.4 mm) from the device, is:

- High: 107 dB
- Medium: 92 dB
- Low: 82 dB



See section 13.2 for more information about adjusting EXO's siren volume.

▲ WARNING: Listening to EXO's siren at high volume for extended periods of time can cause permanent hearing loss. Adjust EXO's siren volume for use indoors and in smaller spaces. Wear appropriate ear protection during testing.

6.9 SPEAKER

The speaker is used to inform you of the following:

- Notifications triggered by incoming two-way messages
- Connection lost notifications
- Two-way voice calls
- Push-to-talk (PTT) messages
- Shutdown sounds

NOTE: You cannot adjust EXO 8's speaker volume.

7 OPERATIONAL NOTIFICATIONS

Operational notifications communicate events that are triggered by routine and expected device operations. Operational notifications provide you with information or prompt you to take some sort of action. An operational notification includes yellow flashing lights and sound, and an on-screen message specific to the event.

You can configure the settings for operational notifications in Blackline Live to best fit your operational needs. Contact your safety supervisor to learn more about how EXO 8's features are configured.

Operational notifications are local to your device and do not notify monitoring personnel if your device is monitored.

Operational notifications repeat until you acknowledge them.

7.1 ACKNOWLEDGING OPERATIONAL NOTIFICATIONS

To acknowledge an operational notification:

1. Read EXO's screen.
2. Press and hold the left and right buttons at the same time to mute the notification and acknowledge the banner message.

A safety supervisor or someone with proper training for EXO should perform specific tests or procedures to address the issue (e.g., calibrating the device).



7.2 OPERATIONAL NOTIFICATION TYPES

Operational notifications include:

- Low battery
- Lost connection
- Bump test due (Optional)
- Calibration due (Optional)
- Timer done

Low battery

The low-battery notification interval is configurable (1% to 30%) in Blackline Live. Your Blackline Live administrator can also mute the notification sound and LED patterns associated with this notification.

The low-battery notification is activated when EXO detects that it is operating below the configured low-battery threshold.

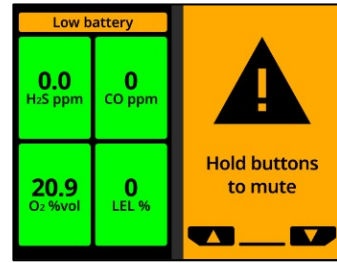

Network lost

The network lost interval is configurable (min.) in Blackline Live.

The network lost notification is activated when EXO fails to connect with Blackline Live for the configured time interval (e.g., 5 min).

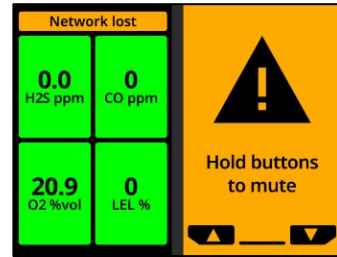

Bump test due (Optional)

The bump test due notification interval is configurable in Blackline Live. Your Blackline Live administrator can also mute the bump test due notification sound and LED patterns.

The bump test due notification is activated when EXO is due for a bump test within the interval (days) configured in Blackline Live.

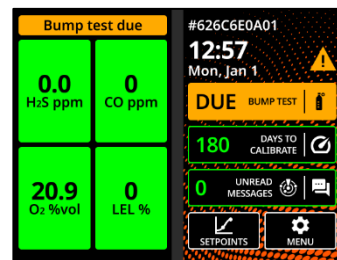
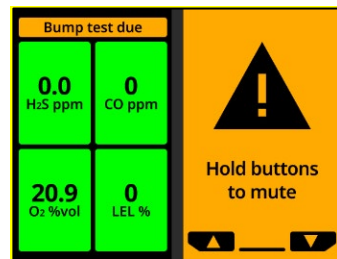

Calibration due (Optional)

The calibration due notification interval is configurable in Blackline Live. Your Blackline Live administrator can also mute the calibration due notification sound and LED patterns.

The calibration due notification is activated when EXO is due for calibration within the interval (days) configured in Blackline Live.

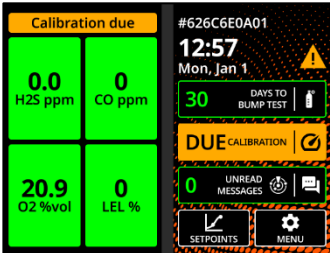
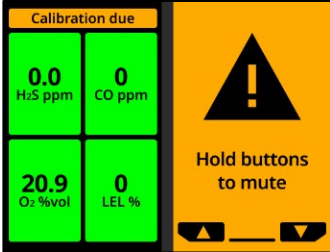

Timer done

The timer done notification is activated when EXO timer counts down to zero.

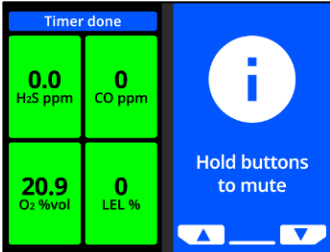

8 LOW URGENCY NOTIFICATIONS

Low urgency notifications communicate events that are triggered by an unexpected condition that could pose a safety risk if not addressed in a timely manner. A low urgency notification includes yellow flashing lights and sound, and an on-screen message specific to the event.

You can configure the settings for low urgency notifications in Blackline Live to best fit your operational needs. Contact your safety supervisor to learn more about how EXO 8's features are configured.

Low urgency notifications are local to your device and do notify monitoring personnel if your device is monitored. Event data related to low urgency notifications is uploaded to Blackline Live during your device's next synchronization.

Low urgency notifications repeat until you acknowledge them.

8.1 ACKNOWLEDGING LOW URGENCY NOTIFICATIONS

To acknowledge a low urgency notification:

- ▲ **WARNING:** Always follow your company's safety protocol for responding to low urgency notifications. For gas and gamma related notifications, Blackline recommends leaving the area.
1. Read EXO's screen and inform personnel if they need to leave the area.
 2. Press and hold the left and right buttons at the same time to mute the notification and acknowledge the banner message.
- NOTE:** For continuous gas or gamma exposure, EXO unmutes after two minutes if gas or gamma levels have not returned to normal.



8.2 LOW URGENCY NOTIFICATION TYPES

Low urgency notifications include:

- Incoming message
- Two-way voice call
- Errors (hardware, cartridge, sensor, firmware)
- Low threshold
- Sensor under limit
- Pump blocked
- Tumble (Optional)
- AlertLink
- Low gamma

Incoming message

EXO can receive messages from monitoring personnel via Blackline Live. Messages are available in your device's Message inbox. See section 12.1 for more information on messages.

The incoming message notification is activated as soon as your device receives a message.

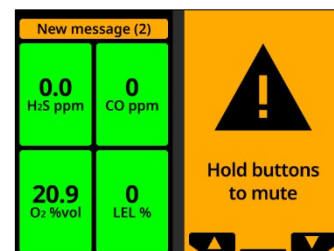

Two-way voice call

If EXO has the two-way voice call feature enabled and is in cellular coverage, it can receive two-way voice calls from monitoring personnel, such as during a response to a high-urgency notification.

You cannot initiate or end voice calls from EXO. Voice calls are automatically answered by EXO. See section 12.2 for more information on two-way voice calls.

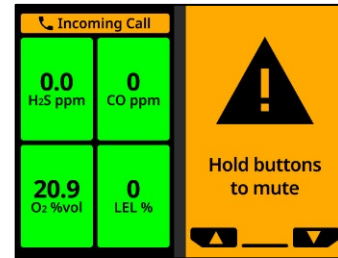

Errors (hardware, cartridge, sensor, firmware)

The error notification is activated when EXO experiences an error (e.g., your gas sensor stops working).

NOTE: Following an error notification, Blackline recommends that you power off and restart your device. If the error persists, try updating the firmware (see section 0). If the error does not clear, contact Blackline [Technical Support](#).

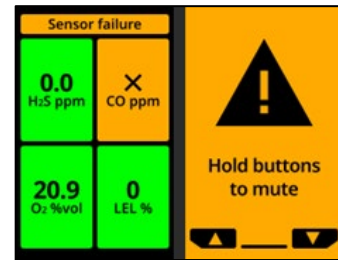

Low threshold

The low gas threshold is configurable in Blackline Live.

The low gas notification is activated when gas levels reach the configured threshold for your device.

NOTE: An EXO with an O₂ sensor notifies you in both oxygen-deficient and oxygen-enriched atmospheres. An oxygen-deficient atmosphere poses a risk of insufficient oxygen for breathing. An oxygen-enriched atmosphere presents an increased risk of explosion.

NOTE: You can choose to mute the sound portion of a low-gas notification, but the lights remain active.

Persistent lights and recurring sounds are there to encourage you to leave, and to help emergency responders locate you if you lose consciousness or cannot remove yourself from the area.

After acknowledging a low-gas notification, move to an area where gas is not present. If you do not leave the area and gas levels remain above the low threshold, the low gas notification reactivates after two minutes.

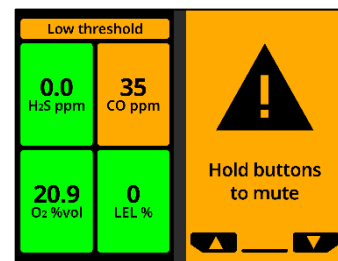

Sensor under limit

The sensor under limit (UL) notification is activated when your device detects a UL event.

NOTE: Following a UL notification, no peak is logged because the UL event type is closely related to a device or sensor error. To resolve the UL event, Blackline Safety recommends that you calibrate your device. For more information on calibration, refer to section 10.4.

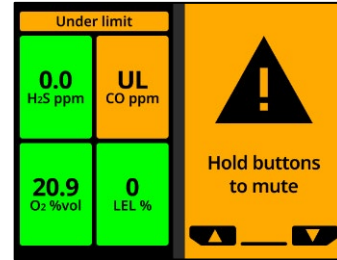

Pump blocked

The pump blocked notification is activated when your pump inlet is blocked.

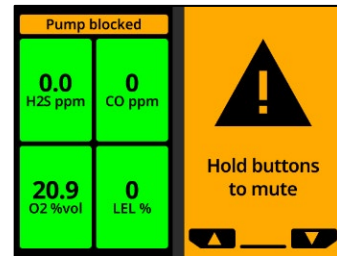

Tumble alarm (Optional)

When tumble alarm is enabled, EXO triggers a low-urgency notification if it is knocked over. In addition to lights and sounds, you can view the event in the device history and, if a notification profile is configured, a message is sent to identified contacts.

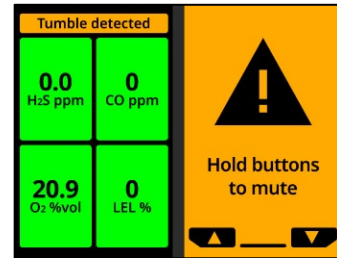

AlertLink

AlertLink notifications let you know that another G7c, G7x, EXO, or EXO 8 Gamma device within the configured proximity radius is experiencing a high urgency event. AlertLink notifications trigger a unique light and sound pattern.

NOTE: AlertLink is only available for self-monitored or Blackline-monitored organizations.

Your EXO receives a message at the time of the triggering event, which includes the alert type, the assigned user of the origin device, the origin device type, other device information, and gas type when applicable.

When the AlertLink notification is activated, proceed based on your company's safety protocol.

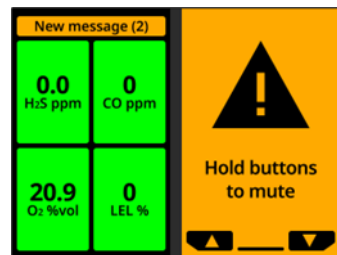

blacklinesafety

You can configure the notification to persist for a maximum of 90 minutes until it is manually acknowledged on the device or to clear automatically after pre-set period of time (15-minute default).

The notification can also be cleared remotely by monitoring personnel in Blackline Live.

AlertLink functionality and the proximity radius can be configured in Blackline Live. You can also exclude EXO devices from receiving AlertLink notifications in Blackline Live.

For more information, see the [Blackline Live Technical User Manual](#).

Low gamma

If your EXO device has a gamma sensor installed, the low threshold notification is activated when gamma levels reach the configured threshold for your device.

The low gamma threshold is configurable in Blackline Live.

NOTE: You can choose to mute the sound portion of a low gamma notification, but the lights remain active.

Persistent lights and recurring sounds are there to encourage you to leave, and to help emergency responders locate you if you lose consciousness or cannot remove yourself from the area.

After acknowledging a low threshold notification, move to an area where gamma radiation is not present. If you do not leave the area and gamma levels remain above the low threshold, the low threshold notification reactivates after two minutes.

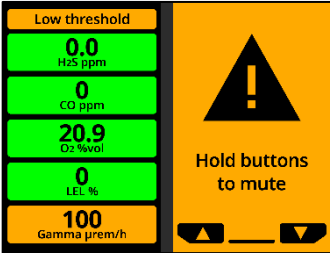

9 HIGH URGENCY NOTIFICATIONS

High urgency notifications communicate events that require your immediate attention and action. A high urgency notification includes red flashing lights, sound, and an on-screen message specific to the event.

If your organization is monitored, high urgency notifications are immediately communicated to monitoring personnel and automatically generate an alert in Blackline Live. If gas levels return to normal or you manually mute the sound, notifications are NOT cancelled and are sent to monitoring personnel.

NOTE: If your configuration profile has Gas Alert Countdown enabled, communication to monitoring personnel is delayed by 30 seconds (default). The duration of the delay is configurable in Blackline Live.

9.1 ACKNOWLEDGING HIGH URGENCY NOTIFICATIONS

To acknowledge a high urgency notification:

1. Immediately evacuate the area and follow your company's emergency safety protocol.
2. If you know the area is safe and your company's protocol allows you to stay in the area:
 - a. Read EXO's screen.
 - b. Press and hold the left and right buttons at the same time to mute the notification and acknowledge the banner message.



NOTE: For continuous gas exposure, EXO unmutes itself after one minute if detected gas levels have not returned to normal.

9.2 HIGH URGENCY NOTIFICATION TYPES

High urgency notifications include:

- High threshold
- SOS triggered
- Over limit (OL)
- High gamma

High threshold

The high gas threshold notification activates when EXO detects gas levels above the high gas concentration threshold configured in Blackline Live.

NOTE: A device equipped with an O₂ sensor activates high-gas notifications in both oxygen-deficient and oxygen-enriched environments.

When you acknowledge the high threshold notification, the device's banner and lights reflect the high threshold status until the gas conditions dissipate and the high threshold event resolves.

If gas levels remain above the high threshold for more than 60 seconds, the high threshold notification retriggers with lights and sound until the high threshold event resolves.

EXO has a high gas countdown timer that is configurable (enabled/disabled) in Blackline Live. Enabling the countdown timer can help reduce the frequency of false high threshold event notifications. If enabled, the countdown timer delays connecting to Blackline Live for 30 seconds (default).

If AlertLink is enabled, G7c and EXO devices within the configured proximity radius of your device at the time of the triggering event receive a low urgency notification and a message with the alert details.

NOTE: You can exclude EXO and EXO devices from receiving AlertLink messages.

Following the high threshold notification, the highest logged peak value of the high threshold event is displayed on the Gas options screen. The device shows the peak value recorded until a new peak is reached, or the peak value is reset during a power cycle of the device.

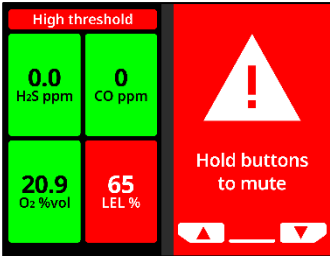

Over limit (OL)

The sensor over limit (OL) notification activates when EXO detects that the gas reading has exceeded the range of its sensor.

When you acknowledge the OL notification, EXO's banner and lights reflect the high gas status until the gas conditions dissipate and the OL event is resolved.

If AlertLink is enabled, G7c and EXO devices within the configured proximity radius of your device at the time of the triggering event receive a low urgency notification and a message with the alert details.

NOTE: You can exclude EXO and EXO devices from receiving AlertLink messages.

Following the OL notification, the OL event displays on the Gas options screen. The device shows the peak value recorded until a new peak is reached, or the peak value is reset during a power cycle of the device.

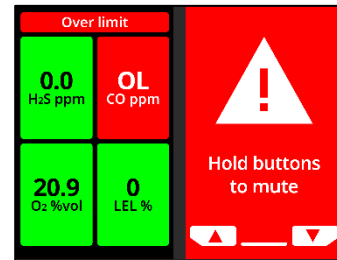

SOS alert

For immediate assistance, you can manually send an SOS to monitoring personnel and request help to your location by pulling the SOS latch.

When you acknowledge the notification, your device's banner and lights reflect the SOS status until the SOS event is resolved.

NOTE: The SOS alert notification is configurable in Blackline Live.

If AlertLink is enabled, G7c and EXO devices within the configured proximity radius of your device at the time of the triggering event receive a low-urgency notification and a message with the alert details.

NOTE: You can exclude EXO devices from receiving AlertLink messages.

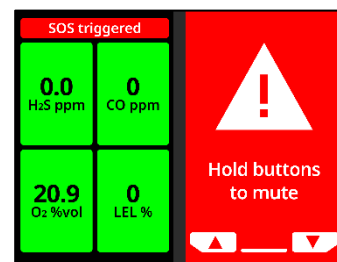

High Gamma

If your EXO device has a gamma sensor installed, the high threshold notification activates when EXO detects gamma levels above the high gamma concentration threshold configured in Blackline Live.

When you acknowledge the high threshold notification, the device's banner and lights reflect the high gamma status until the gamma conditions dissipate and the high threshold event resolves.

If gamma levels remain above the high threshold for more than 60 seconds, the high threshold notification retriggers with lights and sound until the high threshold event resolves.

If AlertLink is enabled, G7c and EXO devices within the configured proximity radius of your device at the time of the triggering event receive a low-urgency notification and a message with the alert details.

NOTE: You can exclude EXO devices from receiving AlertLink messages.

Following the high threshold notification, the highest logged peak value of the high threshold event displays on the Gamma info screen. The device shows the peak value recorded until a new peak is reached, or the peak value is reset during a power cycle of the device.

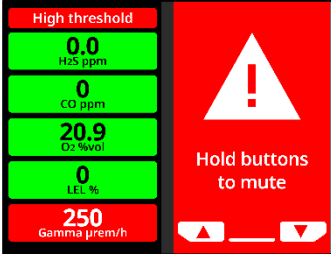

9.3 LIVE RESPONSE

The blue LiveResponse light indicates that remote monitoring personnel are responding to an alert by following your team's emergency protocol. When monitoring personnel confirm the safety of everyone in the area and resolve the alert, the blue LiveResponse light shuts off.

Depending on your team's response protocol, if the EXO is voice enabled, the monitoring agent can initiate a two-way conversation with the end user.



▲ WARNING: Do NOT power off EXO if the blue LiveResponse light is on.

10 GAS AND GAMMA DETECTION

10.1 VIEWING AND RESETTING GAS READINGS

Use the Gas options menu to view and reset the peak gas readings.

To view and reset peak gas readings:

1. Open the Main menu.
2. Select Gas options.

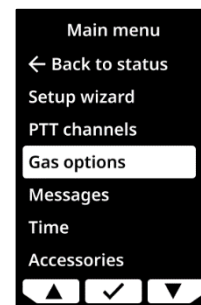

3. Select View gas info.

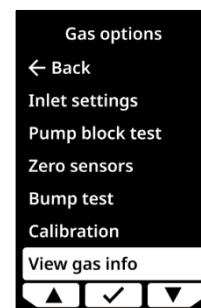

4. To view peak readings, select **Peak readings**.

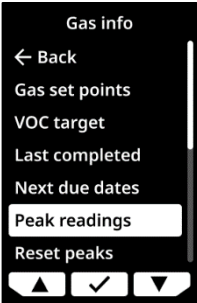

Or to reset peak readings, select **Reset peaks**.

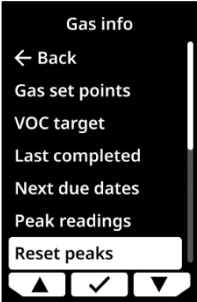

5. Select **✓** to reset the peak readings or **✗** to cancel.

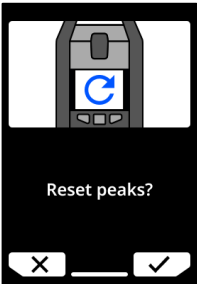

10.2 VIEWING AND RESETTING GAMMA READINGS

If your EXO device has a gamma sensor installed, use the Gamma info menu to view gamma set points, as well as view and reset the peak gamma reading.

To view gamma set points:

- 1. Open the Main menu.
- 2. Select Gamma info.

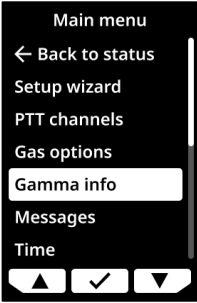

3. To view gamma set points, select **Gamma set points**.

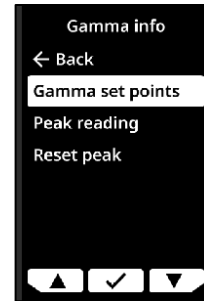

The Gamma set points screen displays.

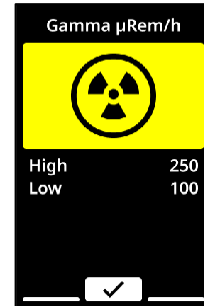

To view and reset peak gamma readings:

1. Open the Main menu.
2. Select **Gamma info**.

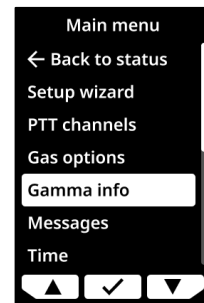

3. To view the peak reading, select **Peak reading**.

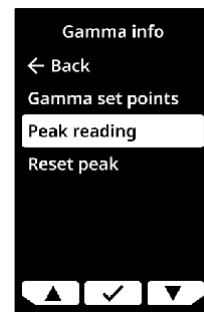

Or to reset the peak reading, select **Reset peaks**.

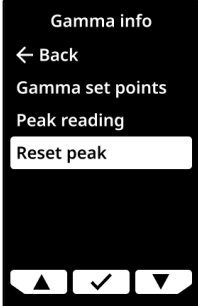

- 4. Select ✓ to reset the peak readings or ✗ to cancel.

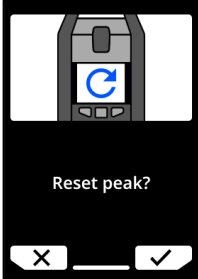

10.3 BUMP TEST

Bump testing verifies that EXO's gas sensors and notification indicators (lights, siren, speaker, and microphone) are functioning correctly. During a bump test, you apply a known concentration and amount of gas to confirm the sensors will trigger a notification in the event of gas exposure.

EXO automatically communicates the data collected from each bump test to Blackline Live when it is connected to the cellular or satellite network.

Bump test schedule

You can configure the bump test schedule to match your company's safety policy. These changes are made in the configuration profile in Blackline Live.

Blackline recommends that your bump test interval not exceed 30 days. Where site or regulatory requirements are more stringent, Blackline recommends the more stringent requirements apply.

The bump test results in either a pass or fail. Exiting the bump test before all sensors have been tested results as a fail.

EXO displays when the next bump test is due during start-up and on the Home screen. By default, an overdue bump test causes a reminder message to display in the banner of the Gas status screen. The bump test overdue reminder is configurable in Blackline Live.

Gas cylinders

You can manually bump test gas sensors at the same time using one gas cylinder with a multi-gas mixture or individually using multiple gas cylinders. If using multiple cylinders, you must repeat the manual bump test procedure for each cylinder. In step 6 of the manual bump test procedure (section 10.3.1), ensure you select each gas sensor that corresponds to the attached cylinder's gas mixture. The gas concentration of the connected gas cylinder should match the gas concentration listed in EXO's calibration gas configuration in Blackline Live.

NOTE: Some cartridges require you to bump test sensors in a specific order due to gas sensor cross sensitivity. For more information, see [G7 and EXO Gas Sensor Bump Testing and Calibration Order](#).

Gamma Sensor Bump Testing

Bump testing is not required for the gamma sensor, but it can be performed as a confidence check. Confirm applicable laws in your country prior to bump testing to determine what check source type/size is appropriate.

To perform a bump test on a gamma sensor:

1. Hold a check source near the device.
NOTE: Cs-137 is the standard check source.
2. Confirm the displayed dose rate increases.

10.3.1 MANUAL BUMP TEST

To perform a manual bump test, you need:

- A cylinder or cylinders containing the appropriate gas(es)
- A 0.5 LPM (or 1 LPM for Cl₂, HCN, NO₂, NH₃, SO₂, or H₂S) fixed-flow regulator attached to the cylinder(s)
- A tube fitted with a quick connect coupling insert

NOTE: If you are bump testing EXO 8 Diffusion in a windy environment, you must use the wind guard. See section 0 for more information on using the wind guard.



To perform a manual bump test:

1. Ensure EXO is in clean air.
2. To navigate directly to Bump test from the Home screen, use the left and right buttons to scroll, then press the center button to select **Days To Bump Test**. Skip to step 3.

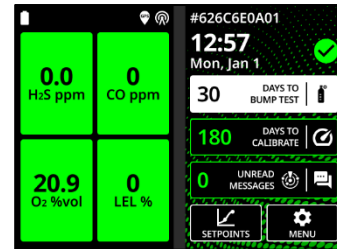

Or to navigate to Bump test from the Main menu, open the Main menu.

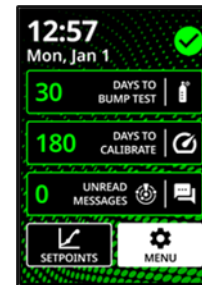

Select **Gas options**.

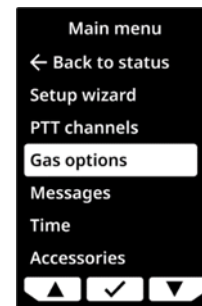

Select **Bump test**. A screen opens displaying the message, "Continue with bump test?"

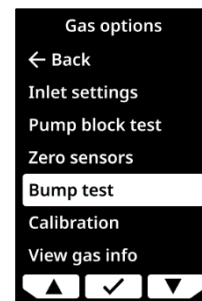

Select . EXO runs an audio/visual self test. See section 6.7 for more information.

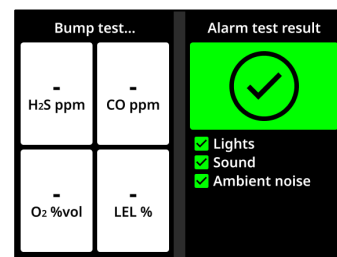

3. When prompted to start the bump test, ensure the gas sensors you wish to bump test are selected. By default, EXO tests all sensors.
4. Select **Start bump**.

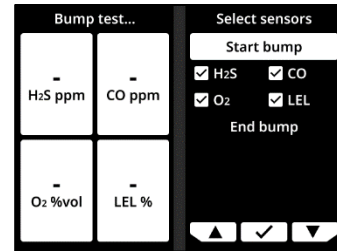

EXO begins to count down from 60 seconds. Within this time window:

- a. Attach a tube fitted with a quick connect coupling insert to EXO's manual calibration inlet.

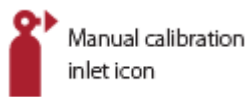

- b. Confirm the other end of the tube is attached to the fixed-flow regulator on the gas cylinder.
- c. Turn on the gas regulator to apply the gas.

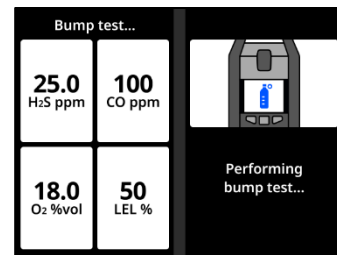

5. Turn the gas regulator off when prompted by EXO.

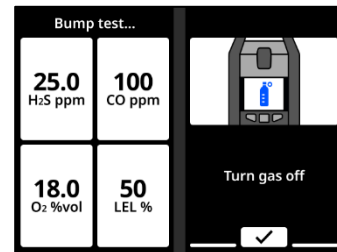

6. Go through steps 6-9 until all sensors have been tested. The bump test procedure is only considered successful when all the sensors are successfully tested.

7. If all sensors are successfully tested, press the center button to complete the bump test. This screen times out after a few seconds. EXO displays a pass or fail message and when the next bump test is due.

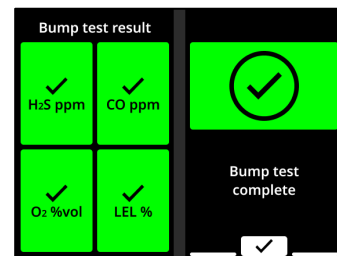

8. Remove the tube from the manual calibration inlet, then let EXO sit until the gas readings stabilize. This may take a few minutes.

If a bump test fails:

- Check the gas and cylinder connections.
- Let EXO sit until its gas readings stabilize.
- Try the bump test again.
- If the bump test continues to fail, contact your organization's safety supervisor.

10.4 CALIBRATION

Calibration ensures EXO's gas sensors can accurately detect gas levels through their operating life. During calibration, you apply a known concentration of gas for a set amount of time to adjust the sensors' parameters.

EXO automatically communicates the data collected from each calibration to Blackline Live when it is connected to the cellular or satellite network.

NOTE: Manual calibration is not required for the EXO 8 Gamma, as the gamma sensor is factory calibrated.

Calibration schedule

You can configure the calibration schedule to match your company's safety policy. These changes are made in the configuration profile in Blackline Live. Although by default the sensors on a cartridge have the same calibration schedule, you can choose to calibrate sensors individually where each sensor's calibration becomes due independent of the other sensors.

Blackline recommends calibrating the sensors on a cartridge in a single calibration procedure.

EXO displays when the sensors' next calibrations are due during start-up and on the Home screen. By default, an overdue calibration causes a reminder message to display in the banner on the Gas status screen. This overdue response is configurable in Blackline Live.

NOTE: Blackline recommends not exceeding 180 days without a calibration.

Gas cylinders

You can manually calibrate sensors at the same time using one gas cylinder or individually using multiple gas cylinders. If using multiple cylinders, manual calibration must be repeated for each cylinder. In step 6 of the manual calibration procedure (section 10.4.1), ensure you select the gas sensors that correspond to the attached cylinder's gas mixture. The gas concentration of the connected gas cylinder should match the gas concentration listed in EXO's calibration gas configuration in Blackline Live.

NOTE: Some cartridges require you to calibrate sensors in a specific order due to gas sensor cross sensitivity. For more information, see [G7 and EXO Gas Sensor Bump Testing and Calibration Order](#).

10.4.1 MANUAL CALIBRATION

For a manual calibration, you need:

- A cylinder or cylinders containing the appropriate gases
- A 0.5 LPM (or 1 LPM for Cl₂, HCN, NO₂, NH₃, SO₂, or H₂S) fixed-flow regulator attached to the cylinder(s)
- A tube fitted with a quick connect coupling insert

NOTE: If you are calibrating EXO Diffusion in a windy environment, you must use the wind guard. See section 0 for more information on using the wind guard.

To perform a manual calibration:

1. Ensure EXO is in clean air.
2. To navigate directly to Calibration from the Home screen, use the left and right buttons to scroll, then press the center button to select **Days To Calibrate**. Skip to step 3.

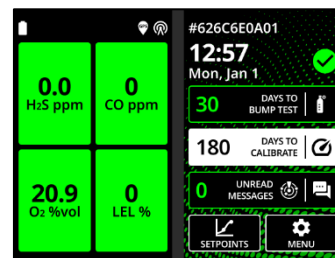

Or to navigate to Calibration from the Main menu, open the Main menu.



Select Gas options.

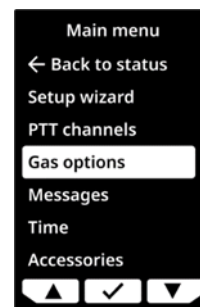

Select **Calibration**. A screen listing the configured calibration settings opens, followed by a screen that displays, "Continue with calibration?"

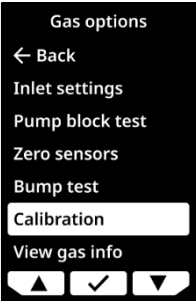

- 3. Select . EXO runs an audio/visual self test. See section 6.7 for more information.

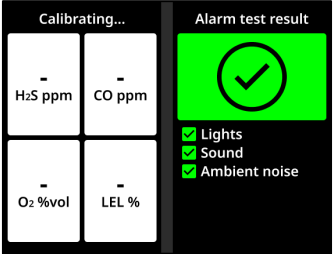

- 4. When prompted, ensure the gas sensors you wish to calibrate are selected. By default, EXO zeroes all sensors.
- 5. Select **Start zeroing**. Selected sensors are zeroed in preparation for their calibration. This takes a few seconds.

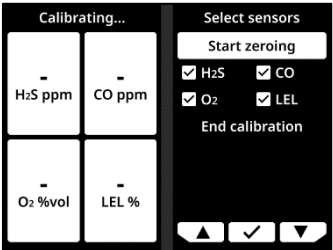

- 6. When prompted, ensure the gas sensors you wish to calibrate with the chosen gas cylinder are selected. By default, EXO tries to calibrate sensors that have been successfully zeroed.

- 7. Select **Start span**.

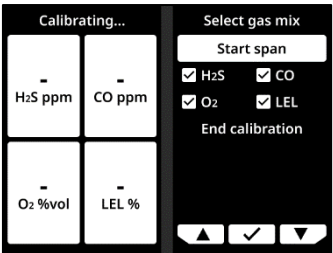

- 8. EXO begins to count down from 60 seconds. Within this time window:
 - a. Attach a tube fitted with a quick connect coupling insert to EXO's manual calibration inlet.

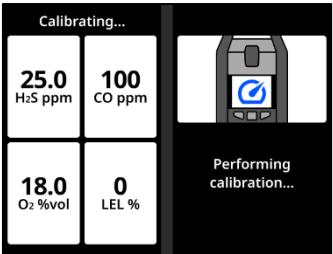

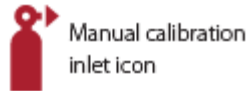

- b. Ensure the other end of the tube is attached to the fixed-flow regulator on the gas cylinder.
- c. Turn on the gas regulator to apply the gas.

- 9. Turn the gas off when prompted by EXO.

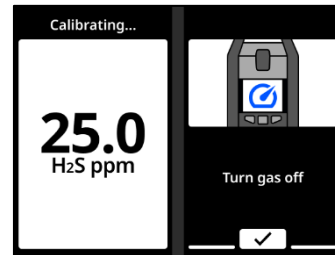

- 10. Follow the prompts to go through steps 8 to 9 until all zeroed sensors are calibrated. Calibration is only considered successful when all the sensors are calibrated.

- 11. When prompted, press the center button to complete the calibration. This screen times out after a few seconds. EXO displays a pass or fail message and when the next calibration is due.

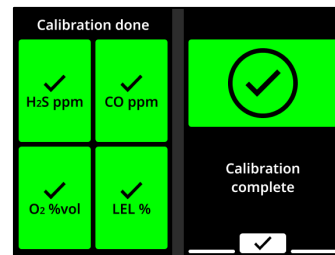

- 12. Remove the tube from the manual calibration inlet and let EXO sit until the gas readings stabilize.

If EXO displays a "Calibration fail" message:

- Check the gas and cylinder connections.
- Check that cylinder gas concentrations match EXO calibration gas configuration.
- Let EXO sit until its gas readings stabilize.
- Try the calibration again.

If the calibration continues to fail, contact your organization's safety supervisor.

If you know EXO is in a clean atmosphere and a gas sensor is reading abnormal levels, this can mean the sensor's baseline has shifted and EXO's displayed gas readings are not

accurate. Try calibrating the sensor. If the sensor is still reading abnormal levels, you may need to zero the sensor.

10.5 AUTOMATIC BUMP TESTS AND CALIBRATIONS

Blackline Safety offers an Automatic Bump Test and Calibration feature that enables EXO to automatically perform bump tests or calibrations so your device can operate unattended on a worksite.

NOTE: This feature is not available for EXO Diffusion.

The Automatic Bump Test and Calibration feature requires a service plan and hardware accessories. The required hardware accessories include:

- EXO 8 Pump or EXO 8 Gamma Pump
- Solar Panel and the Solar Panel Mounting Kit (ACC-G7EXO-UMK-SOLAR-MOUNT-KIT)

NOTE: You can use the trickle charger instead of a solar panel to supply continuous power to EXO.

- Two Gas Tank Mount Kits (ACC-G7EXO-UMK-GAS)
- Universal Mount Kit (ACC-G7EXO-UMK)
- Quad Gas 34L gas cylinder
- Ultra Zero Grade Air gas cylinder
- A 0.5 LPM demand-flow regulator attached to the cylinder(s)
- Tubing
- Inlet Particulate Filter (ACC-INLET-FILTER)

For more information about the automatic feature and the optional hardware accessories, contact your Customer Relationship Manager (CRM).

EXO initiates a bump test or calibration when the test is due. You can configure EXO's pump inlets 1 and 2 to complete automatic bump tests and calibrations in Blackline Live. Pump inlets 1 and 2 must be connected to a gas cylinder with a multi-gas mixture and the ultra-zero grade air gas cylinder (required for calibrations). Inlets 3 and 4 can be used for gas sampling when automatic bump tests and calibrations are enabled. For more information on configuring automatic bump tests and calibrations, see the [Blackline Live Technical User Manual](#).

NOTE: The ultra-zero grade air gas cylinder has an O₂ composition of 20.9% and N₂ for balance. Do not use a gas cylinder with an O₂ composition of 18% during calibrations, as it can affect the baseline of the O₂ sensor.

Failed Bump Tests and Calibrations

If an automatic bump test or calibration fails, EXO displays a bump test due or calibration due notification. EXO continues to operate with the active notification until you perform a manual bump test or calibration.

Blackline recommends that you set up text or email notifications in Blackline Live to notify you if an automatic bump test or calibration fails, or if a pump block is detected. See the [Blackline Live Technical User Manual](#) for more information.

10.6 ZERO SENSORS

If you are in a known clean environment with no gas and EXO's sensors display a gas reading, you can manually zero your sensors to reset the baseline. You can configure EXO to zero its sensors automatically on start-up. The sensors are also zeroed as a part of the calibration procedure.

Contact your safety supervisor to learn more about how your EXO's features are configured.

NOTE: LEL-MPS sensors must be started in clean air and zeroed on start-up to function properly. See section 10.7 for more information about LEL sensors.

10.6.1 MANUAL ZERO SENSORS

You can zero a sensor by using the atmosphere to reset the sensor's baseline reading. You can also apply inert purge gas to the manual calibration inlet to zero sensors.

- ▲ **WARNING:** You must zero EXO's sensors with clean air. If a sensor is zeroed where its targeted gas levels are abnormal, the gas levels EXO displays will not be accurate. Inaccurate readings are a safety hazard.

To zero sensors:

1. Ensure EXO is in clean air.
2. Open the Main menu.

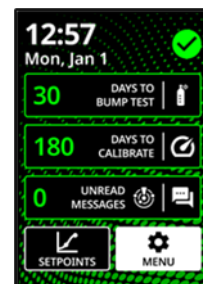

3. Select Gas options.

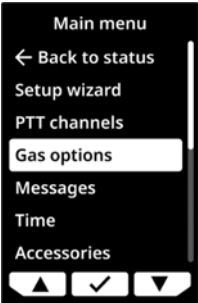

4. Select Zero sensors.

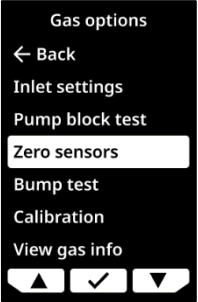

5. When prompted, ensure the gas sensors you wish to zero are selected.

6. Select Start zeroing.

NOTE: Do NOT apply gas.

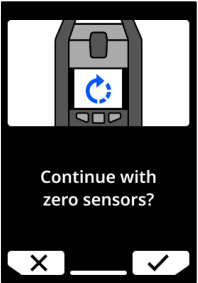

A message displays to indicate when the zeroing is completed.

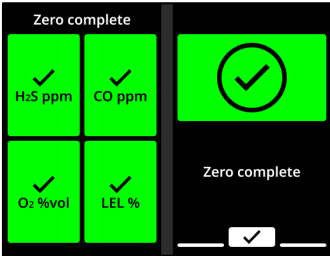

If you see a "Zero incomplete" message on EXO's screen:

- EXO may be in an environment with abnormal gas levels.
- EXO's cartridge may need to be replaced.

10.7 LEL SENSOR PRECAUTIONS

For safety reasons, EXO must be operated and serviced by qualified personnel only. Read and understand the following information before operating or servicing.

- ▲ **WARNING:** Off-scale (overlimit) readings may indicate an explosive concentration.
- ▲ **WARNING:** Calibrations must only be performed in areas free of flammable gases.

Blackline's LEL sensors can be calibrated with the following settings:

Gas	Calibration concentration (%vol)	Calibration concentration (%LEL)	Balance
Methane (CH ₄)	2.5%	50% ±2%	Standard quad-gas mixture

No known gases desensitize or contaminate Blackline's LEL-MPS and LEL-IR sensors. These two sensors do not cause any electromagnetic interference (EMI), and are not negatively affected by EMI, such as radio transmissions of up to 8W.

Some compounds will decompose on the catalyst of the LEL-P and form a solid barrier over the catalyst surface. This action is cumulative, and prolonged exposure results in an irreversible decrease in sensitivity. The most common of these substances are compounds containing lead or sulphur, silicones, and phosphates.

Some other compounds, especially hydrogen sulphide and halogenated hydrocarbons, are absorbed or form compounds that are absorbed by the catalyst of the LEL-P. The resulting loss of sensitivity is temporary. In most cases, a sensor recovers after a period of operation in clean air.

Like any gas sensor, be sure to understand potential explosive hazards and choose the appropriate sensor technology based on these hazards.

Blackline Safety supports three different LEL sensor technologies:

- Molecular Property Spectrometer (LEL-MPS)
- Non-Dispersive Infra-Red (LEL-IR)
- Pellistor (catalytic bead) (LEL-P) (EU/UK only)

NOTE: LEL sensors cannot be disabled in Blackline Live.

Molecular Property Spectrometer (LEL-MPS)

This sensor is not intended for inert environments. Environments with oxygen (O₂) levels below 18% negatively impact this sensor's accuracy and Blackline does not recommend using it when oxygen levels are below 10%.

LEL-MPS sensors must be started in clean air and zeroed on start-up to function properly. EXO devices equipped with LEL-MPS sensors cannot perform an automatic zeroing of the LEL-MPS sensor without manual confirmation.



When powering on an EXO with an LEL-MPS sensor, the device prompts you to acknowledge and approve that the device has been powered on in a clean air environment and a zero adjustment can take place. If you fail to acknowledge the zero prompt within 15 seconds, EXO enters a latched alarm state and requires that you power cycle the device and approve the zero prompt.

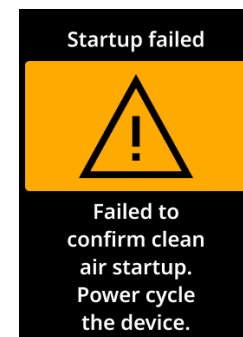

You can configure the clean air confirmation prompt in Blackline Live. If the clean air confirmation prompt is disabled, the device prompts you to perform a manual zero adjustment.

When bump testing or calibrating this sensor, apply a gas mixture containing at least 18% oxygen (O₂). Less oxygen may negatively impact the sensor's readings. If a gas mixture with less than 18% oxygen is applied during a bump test or calibration, restart EXO to auto zero the sensor.

You can calibrate this sensor two ways:

- **Default calibration procedure:** This procedure validates and ensures accuracy without adjusting the LEL-MPS sensor's readings. Unlike traditional sensors, this sensor is factory-calibrated for optimal accuracy. We recommend using the factory calibration for the lifetime of the sensor.
- **Full calibration procedure:** Advanced users can perform a full calibration with a span adjustment. A full calibration may negatively impact the accuracy of other gases. You can configure EXO to run a full calibration on this sensor in Blackline Live.

Non-Dispersive Infra-Red (LEL-IR)

This sensor can function in inert environments without oxygen. This sensor does not detect Hydrogen (H) or Acetylene (C₂H₂).

Pellistor (catalytic-bead) (LEL-P)

Any rapid up-scale reading followed by a declining or erratic reading may indicate a gas concentration beyond the upper scale limit, which may be hazardous.

10.8 PID TARGET GASES

Photoionization detector (PID) sensors can be used to detect a large range of volatile organic compounds (VOCs). The PID sensor's target gas refers to whatever gas your device is currently attempting to detect. EXO's readings are adjusted based on the gas it is currently configured to detect.

NOTE: Although PID sensors target a specific VOC, readings can still be affected by the presence of non-targeted gases. Consult your safety supervisor or industrial hygienist when preparing to use a PID sensor.

EXO's PID sensor's target gas is set from the configuration profile in Blackline Live. Under the Photoionization detector section of the Gas sensor settings card, you can choose an existing target gas or set a custom target gas.

You can see the target gas EXO is configured to use in two places:

- On start-up
- In the Gas options menu: Gas options > View gas info > VOC target

In both places, EXO's screen displays the name of the target gas as well as its correction factor.

10.9 GAS ALERT COUNTDOWN

The gas alert countdown is an optional gas feature that creates a short delay before a high-gas alert is delivered to Blackline Live and to monitoring personnel.

This feature helps prevent false alarms from being delivered to monitoring services. Gases like CO and O₂ can spike and dip very quickly, initiating a high-gas alarm even when gas levels go back to normal.

Typically, when EXO's high-gas threshold—determined in the configuration profile—is crossed, the device immediately sends an alert to Blackline Live. This is done so that monitoring personnel can investigate the incident and follow up with the device user to ensure their safety.



Since the alert is sent immediately, it can create false-alarm scenarios where monitoring personnel is alerted even though the exposure was momentary, and the device user is back in a safe area.

When the gas alert countdown feature is enabled, EXO waits for the configured amount of time before sending the alert. EXO continues to display red lights and a high-urgency notification sound, so the user knows to leave the immediate area.

With the gas alert countdown enabled, the banner at the top of the screen displays the remaining time before an alert is triggered in Blackline Live. If gas levels return to normal before this time has elapsed, the alert is cleared. The gas exposure is still visible in the device history view in Blackline Live but does not appear as an alert in the Alerts list.

The gas alert countdown feature is turned off by default.

NOTE: The gas alert countdown cannot be enabled on the gamma sensor.

To enable the gas alert countdown:

1. Log into Blackline Live, then display the EXO configuration profile. In the gas sensor settings section under each individual sensor, there are two settings:
 - A toggle labeled Gas alert countdown.
 - A dropdown field labeled Gas alert timeout.
2. Flip the toggle on for each sensor you want the countdown enabled for and determine the length of buffer time from the Gas alert timeout dropdown.
3. Save the configuration.

After the devices successfully receive the new settings, the gas alert countdown feature is enabled.

11 GAS INLETS

11.1 MANUAL CALIBRATION INLET



Gas is applied to EXO 8's sensors through the manual calibration inlet during bump testing and calibration.

Fixed-flow regulator

A gas cylinder with a fixed-flow regulator is required to use the manual calibration inlet. This inlet relies on the gas pressure in the attached cylinder to bring the gas to the sensors.

Calibration cap

EXO does not need a calibration cap. The manual calibration inlet ensures the applied gas is fed directly to EXO's sensors.

NOTE: EXO cannot be bump tested or calibrated while a pump inlet is running (see section 11.2).

Attach tube

The manual calibration inlet is fitted with a quick connect coupling nozzle. Attaching a tube to this inlet requires the tube to have the corresponding quick connect coupling insert.

11.2 PUMP INLETS

EXO Pump inlets allow a single EXO to monitor multiple remote areas using tubing. Inlets must be assigned before they are functional.

NOTE: Although EXO Pump inlet filters are an optional accessory, Blackline recommends always installing inlet filters to maintain the pump in good condition. See [EXO Pump Inlet Filters](#) for more information.



To assign inlets:

1. Power on EXO.
2. Open the Main menu.
3. Use the left, right, and center button to select **Gas options**.
4. Select **Inlet settings**. By default, the pump inlets (1 to 4) display as OFF.
5. Attach a tube to the inlet you want to use. Each pump inlet is fitted with a quick connect nozzle. Attaching a tube to these

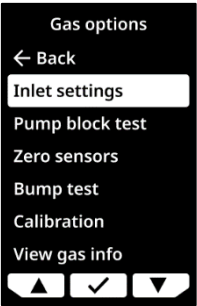
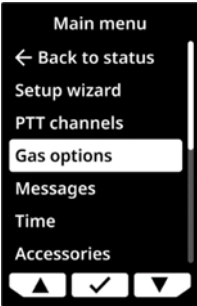

inlets requires the tube to have a corresponding quick connect coupling insert.

6. Select **Inlet settings**, then select the inlet you connected the tube to in step 4. Use the left, right, and the center buttons to toggle the inlet to ON. This pump inlet is now functional.

Purge gas

When an inlet is toggled on, EXO spends two minutes purging. It draws in air to displace any gas that is currently inside EXO and in contact with the cartridge sensors. Gas readings are not available while EXO is purging.

▲ **WARNING:** Gas notifications are NOT generated during a purge.

11.3 GAS SAMPLING

EXO Pump has four inlets to enable flexibility in gas sampling.

▲ **WARNING:** The EXO 8 Pump configuration is not compatible with the following gases: Chlorine (Cl₂), Chlorine Dioxide (ClO₂), Hydrogen Cyanide (HCN), Hydrogen Fluoride (HF), and Ozone (O₃).

Single gas sampling inlet

When one inlet is toggled on, EXO continuously draws air in from that inlet.

▲ **WARNING:** If you start the pump while operating at temperatures of -20°C (-4°F) or lower, EXO generates a pump blocked alarm (see section 11.4) that persists until the inlet warms up and begins operating normally. In a multiple inlet sampling cycle, the inlets do not have time to warm up. For temperatures below -20°C (-4°F), use only single-gas sampling.

EXO first purges for two minutes to clear out any gas from the sensors, then draws air from the inlet that is turned on. When EXO draws from one inlet, it runs continuously from that inlet.

This setup is best for confined-space entry, or any other situation where it is vital to continuously sample from a hazardous area.

Multiple gas sampling inlets

When multiple inlets are toggled on, EXO starts a sampling cycle.

To ensure you always know where gas exposures are coming from, EXO only pulls in gas from one inlet at a time. Note that when multiple inlets are toggled on, EXO goes through each inlet, one at a time.

EXO also purges in between each of the samples to displace gas from the previous sample. While EXO is purging itself, there are gaps in readings.

A sample cycle typically looks like the following:

Purge > Sample from inlet 1 > Purge > Sample from inlet 2 > Purge > Sample from inlet 3.

Due to these gaps in readings, a multiple-inlet sample setup is best used for long-term monitoring of remote areas.

Sample schedule

By default, the sample time from each inlet is three minutes. If you are running all four inlets with default settings (three-minute sample time + two-minute purge time), there is a 20 minute gap between readings from a given inlet.

You can extend the sample time in EXO's configuration profile in Blackline Live. See the [Blackline Live Technical User Manual](#) for instructions.

Pump automatically

By default, pumps remain off when EXO starts. You can change the EXO configuration profile in Blackline Live so pumps automatically turn on when EXO starts. See the [Blackline Live Technical User Manual](#) for instructions.

11.4 PUMP BLOCKED

To ensure dust and debris do not get inside the device, EXO's pump inlets are closed when there is nothing connected to them. Turning on a pump inlet without a tube connected may result in a pump blocked notification to let you know there is no gas coming in from the inlet.

The pump blocked notification also triggers when:

- Gas flow is restricted by something blocking the mouth of the tube.
- The tube gets bent or normal flow is obstructed.
- EXO is operating in temperatures of -20°C (-4°F) or colder.

A pump block detected event generates a low urgency notification and is logged in Blackline Live. You can mute the notification by pressing and holding the left and right buttons, or by connecting an unobstructed tube to the inlet that is trying to pull in air. When an unobstructed tube is connected, the inlet opens to allow air flow, and the notification ends.

After you have muted the pump blocked notification, you can perform a pump block test to confirm that the pump block has cleared.

To perform a pump block test:

1. Open the Main menu.

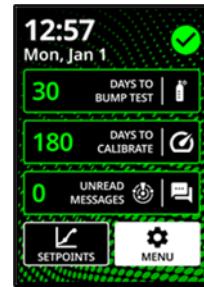

2. Select Gas options.

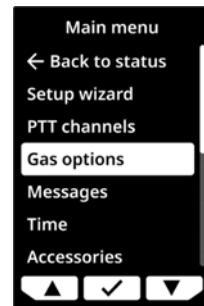

3. Select Pump block test.

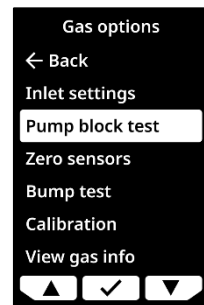

4. Use the left, right, and center button to select **All inlets** to perform a pump block test for all inlets.

Or to perform a block test for a specific inlet, select the **inlet**. EXO begins the pump block test.



A message displays to indicate when the pump block test is completed.

- 5. If a "Block test failed" message displays on EXO's screen, check the tubing for obstructions and try the pump block test again.

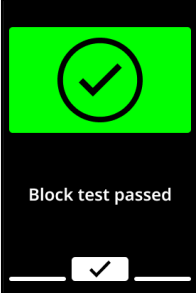

12 FEATURES

12.1 TEXT MESSAGES

EXO 8 can send and receive text messages with monitoring personnel. You can send one of 10 pre-programmed messages or write a custom message. This message is sent to Blackline Live as an alert. Pre-programmed messages are configurable in Blackline Live.

Messages can also be sent from Blackline Live and received by EXO. A low-urgency notification informs you of an incoming message.

To send a pre-programmed message:

- 1. Open the Main menu.

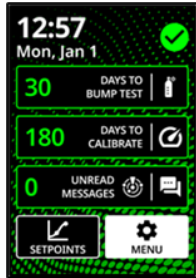

- 2. Select **Messages**.

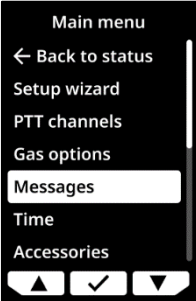

3. Select Send a message.
4. Select a pre-programmed message. EXO displays a confirmation screen, then displays the Gas status screen.

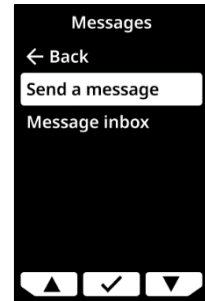

To send a custom message:

1. Open the Main menu.

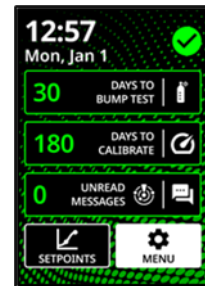

2. Select Messages.

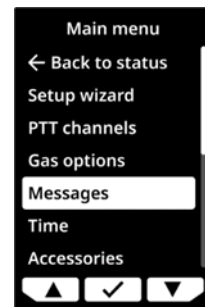

3. Select Send a message.

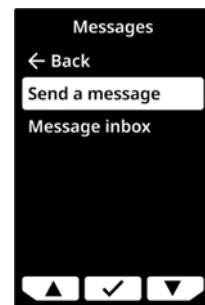

4. Select **Create custom**.

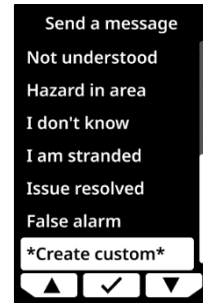

5. Press the left and right buttons to scroll through the alphabet and numbers.
6. Press ✓ to move to the next character.
NOTE: Messages cannot exceed 16 characters.
7. Press ✓ to save the message.

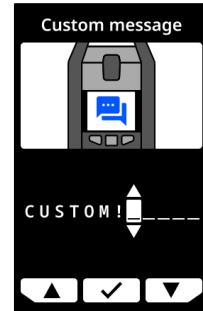

8. Press ✎ to continue editing, ✓ to send, or ✕ to cancel.



To read received messages:

1. Open the Main menu.

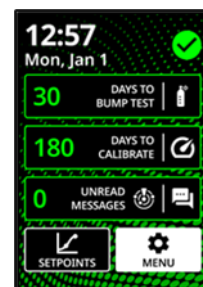

2. Select **Messages**.

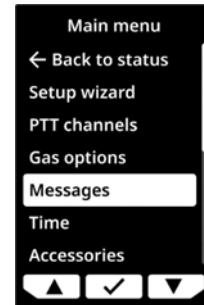

3. Select **Message inbox**.

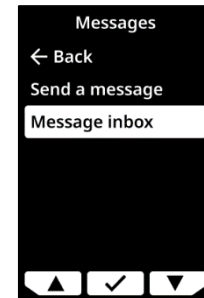

12.2 TWO-WAY VOICE CALLS

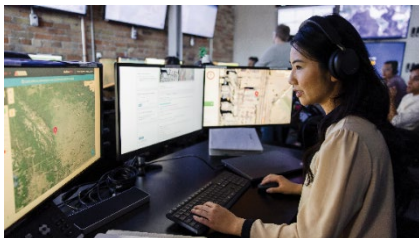

If EXO has the two-way voice call feature enabled and is in cellular coverage, it can receive two-way voice calls from monitoring personnel as a response to high-urgency notifications.

EXO automatically answers every voice call. You cannot initiate or end voice calls from EXO.

Monitoring personnel initiate a voice call. If EXO is not already in a low-urgency or high-urgency state, it informs you of the incoming call with a low-urgency notification. A chirp sounds to indicate the voice call is connected.

Speak directly to EXO. The microphone is located to the left of the SOS latch. If monitoring personnel cannot hear your responses clearly, you may need to move closer to EXO. When monitoring personnel confirm you are safe, they will end the call and another chirp sounds to indicate the voice call is disconnected.

NOTE: This feature is different from the push-to-talk (PTT) feature. Voice calls are not available when EXO uses the Iridium satellite network to connect to Blackline Live.

Volume

Two-way calls use EXO's speaker. The speaker's volume cannot be adjusted. See section 6.9 for more information about the speaker.

12.3 PUSH-TO-TALK (PTT)

If EXO has the push-to-talk (PTT) feature enabled and is in cellular coverage, it can send and receive voice messages with other EXO devices and G7c devices using the same channel, similar to a walkie-talkie. EXO can still receive and send PTT transmissions when it is locked by a maintenance code. See section 6.6 for more information on the maintenance code.

PTT only works when EXO is connected to Blackline Live through a cellular network. PTT does not work during a low-urgency or high-urgency notification state unless the notification has been muted. PTT only allows one transmission on a channel at a time.

Volume

PTT uses EXO's speaker. The speaker's volume cannot be adjusted. See section 6.9 for more information about the speaker.

To transmit PTT calls:

1. Press and hold the red latch.
2. When EXO finishes beeping, continue to hold the latch and begin talking into the device. Your message can be up to 30 seconds in duration.
3. When you are finished talking, release the latch.
4. EXO beeps once more to let you know it is done listening.

To receive a PTT call:

1. EXO beeps twice to signal an incoming PTT message.
2. EXO plays the message.
3. EXO beeps once more when the message is finished.

NOTE: EXO's screen displays its current channel.

12.4 AVAILABLE CHANNELS

Channels 00 through 99

These channels are recommended for everyday use. When on a specific numbered channel, EXO:

- Transmits to devices on the same channel as EXO.
- Receives transmissions from devices on the same channel as EXO, as well as transmissions from devices in the All call channel.

All call channel

This channel is recommended for safety supervisors or managers. The All call channel is the highest priority PTT channel. Incoming All-call transmissions override other PTT transmissions. When on the All call channel, EXO:

- Transmits to all PTT devices in EXO's organization.
- Receives transmissions from devices in the All-call channel.

Receive-only channel

When on the Receive-only channel, EXO:

- Cannot transmit to any devices.
- Receives transmissions from devices in the All call channel.

12.4.1 CHANGING CHANNELS

To change to a specific channel number:

1. Open the Main menu.

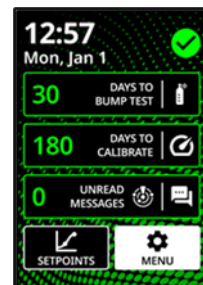

2. Select PTT channels.

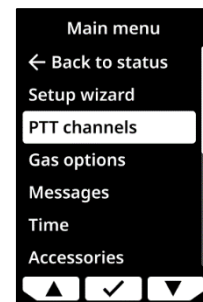

3. Select Enter channel #.

NOTE: Every channel requires two digits.

4. Use the left and right buttons to enter the first digit of the new channel. For channels less than 10, use a leading zero. For example, for channel 08, the first digit is 0.
5. Press the center button to move to the next digit.
6. Use the left and right buttons to enter the second digit of the new channel. For example, for channel 08, the second digit is 8.
7. Press the center button to finish.
8. Select ✓ to confirm the new channel or select ✎ to make changes.

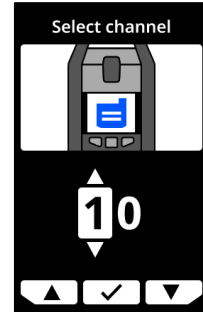
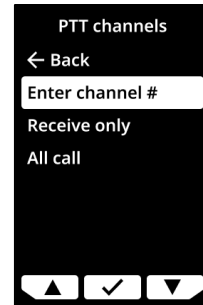

To change to receive only or All call:

1. Open the Main menu.

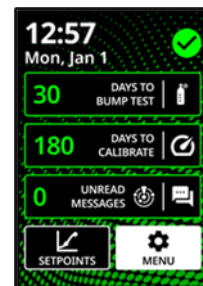

2. Select PTT channels.

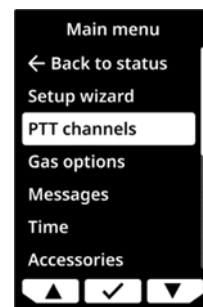

3. Select **Receive only** or **All call**.

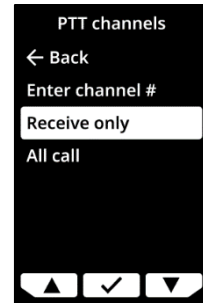

4. Read the message on the screen.

5. Select **✓** to confirm.



12.5 AIRPLANE MODE

When EXO is being placed in an environment with no connectivity or an environment where radio frequency transmissions might be dangerous, EXO's Airplane mode lets you disable wireless communication to and from EXO.

When Airplane mode is on, EXO's notifications and alerts still function, but are not communicated to Blackline Live, and the device does not receive any communications sent from other users or from staff monitoring devices. Events detected while EXO is in Airplane mode are stored on EXO for up to two days, after which EXO starts to overwrite the data, beginning with the oldest events. When Airplane mode is on, it remains on until it is turned off, including through power cycles and longer periods of being powered down.

When Airplane mode is turned off and EXO connects to the network, stored event data is transmitted to Blackline Live. See [Understanding Offline Data Storage for G7 Devices](#) for more details.

NOTE: If EXO is powered off then powered on while in Airplane mode, you are prompted to confirm that you want Airplane mode to remain on. Select the center button to continue in Airplane mode.

See section 14.5 for more information on enabling Airplane mode.

- ▲ **WARNING:** When airplane mode is on, you cannot use the SOS latch or otherwise call for help using EXO.

12.6 STEALTH

When EXO is used in a known hazardous environment, EXO's Stealth functionality lets you silence audible and visual notifications and alerts. When Stealth is enabled, events are still registered and sent to Blackline Live, but they are not available on EXO itself.

- ▲ **WARNING:** When Stealth is enabled, the lights do not flash, the siren does not sound, and EXO does not indicate incoming voice calls. Blackline Safety recommends that you have an alternative channel of communication available when EXO is in Stealth.

Stealth functionality must be enabled in Blackline Live by your company's administrator. When Stealth is enabled for a configuration profile, it is enabled for all EXO devices on that profile and remains enabled for all devices until it is disabled in Blackline Live, including through power cycles and longer periods of being powered down.

NOTE: Blackline Safety must add this functionality before you see it in your Blackline Live organization. For more information, please contact Blackline [Technical Support](#).

Alarms and Alerts

When EXO's Stealth is disabled in Blackline Live, EXO may go into low or high-urgency notification due to a past event that occurred while EXO was in Stealth. SOS notifications must be cleared on the device.

Push-to-Talk (PTT)

You can still use PTT to send messages when EXO is in Stealth, but because the speaker is silenced, you cannot hear incoming calls or PTT messages.

Port A/B

When EXO is in Stealth, you cannot use Port A/B.

12.7 LOCAL TIME

EXO displays the local time on the Home screen. By default, the local time feature uses information gathered from nearby cell towers to determine the time zone and current time based on location, similar to how a cell phone operates.

However, a cellular connection may be unavailable, or your physical location might be on the border between time zones. In these cases, the default settings may provide inconsistent time zone information, and you may need to manually enter a time zone.

To manually enter a time zone:

NOTE: Time zone offsets are relative to Greenwich Mean Time (GMT: 0:00). You may need to look up the offset of your local time zone with respect to GMT—remember to consider daylight savings if your region uses it. The examples below use +1:30 as an offset.

1. Determine the offset relative to GMT for your local time zone.
2. Open the Main menu.

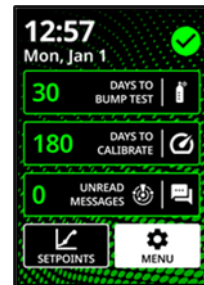

3. Use the left and right buttons to scroll to **Time** and press the center button.

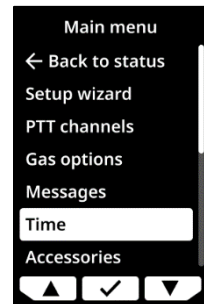

4. Select **Time settings**.

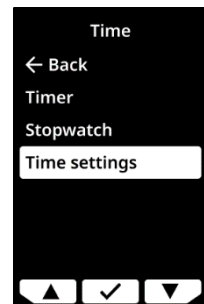

5. Select **Custom offset**.

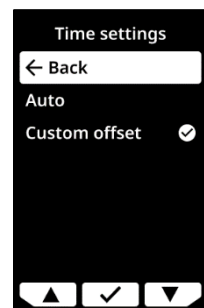

6. Enter + or -.

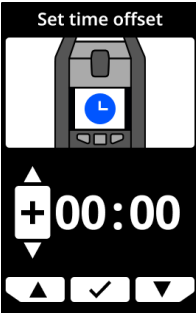

7. Enter the hour.

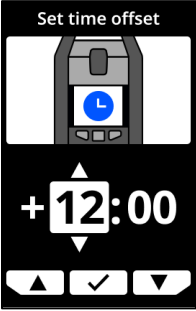

8. Enter minutes, if applicable.

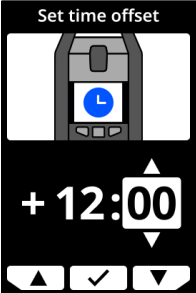

9. Select ✓ to confirm, ✎ to make changes, or ✕ if you no longer want to set an offset.



10. After you input and confirm the offset value, return to the Gas status screen. Confirm that the screen is displaying the correct time based on the entered custom offset value.

To stop using a manual offset:

- 1. Open the Main menu.
- 2. Select **Time**.

3. Select the **Auto** option. EXO reverts to using cellular information to determine the local time.

12.8 TIMER

To set the timer:

NOTE: The timer continues to count down even if you leave the screen.

1. Open the Main menu.

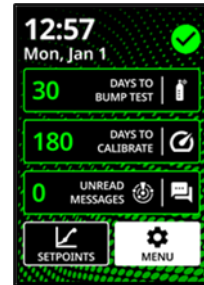

2. Select Time.

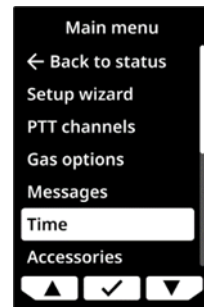

3. Select Timer.

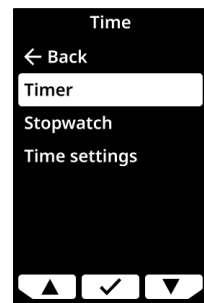

4. On the Set timer screen, select the unit of time (min or sec).

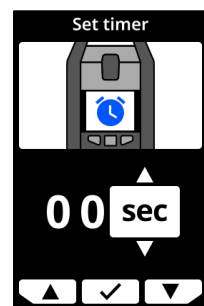

- 5. Use the left and right buttons to adjust the first digit for the time.
- 6. Press the center button to select.
- 7. Repeat steps 5 and 6 to adjust the second digit for the time.

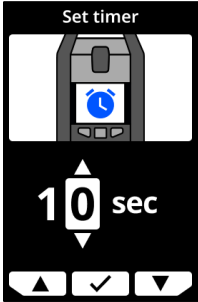
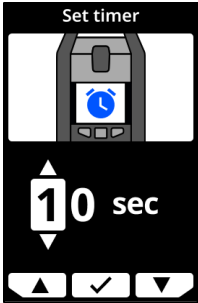

- 8. Select  to make changes or  to confirm the timer duration.

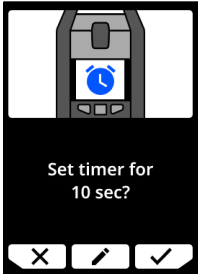

To view and stop the timer:

- 1. When the timer is set, view the remaining time in the Time menu, in-line with the Timer option.



2. To stop the timer early, go to Timer and select ✓.



To stop the timer alarm:

1. When the timer counts down to 0, EXO notifies the user to check the screen. Press and hold the left and right buttons for three beeps to silence the alarm and clear the timer.

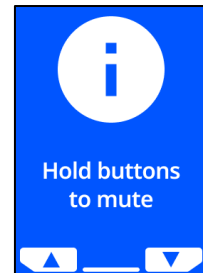

12.9 STOPWATCH

The stopwatch counts in one-second increments. It does not time out or use an alarm. It continues to count in the background even if you leave the stopwatch screen and return to the menu.

To set the stopwatch:

1. Open the Main menu.

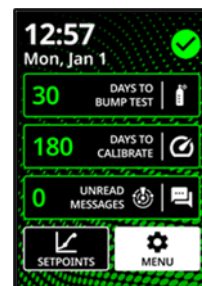

2. Select **Time**.

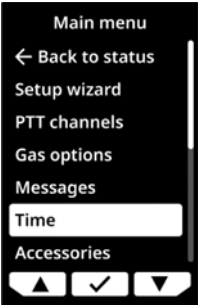

3. Select **Stopwatch**. The Stopwatch screen opens, showing the stopwatch at 00:00:00.

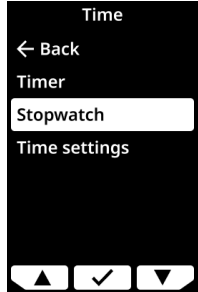

4. To start the stopwatch, select **▶**. You can navigate back to the main screen. The stopwatch continues to run in the background.



5. To see how long the stopwatch has been running, open the **Time** menu.

The stopwatch is displayed in line with the Stopwatch option.

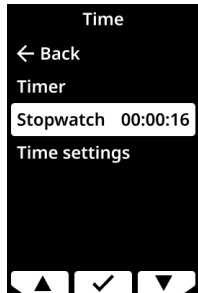

To pause or stop the stopwatch:

1. Open the Stopwatch screen.
2. Press **||** to pause.

After pausing, the Stop option changes to **▶**, and the option **↺** is available.



3. To resume the stopwatch, press **▶**.
4. To reset the stopwatch, press **↺**.



13 DEVICE SETTINGS

EXO 8 Settings menu is where you can access device information and overwrite configuration profile defaults, such as language.

To access the Settings menu:

1. Open the Main menu.

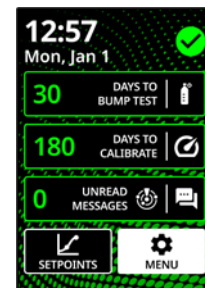

2. Select **Settings**.



13.1 LANGUAGES MENU

Use the Languages menu to view and update your device's language settings. Available languages include:

- English
- Français
- Deutsch
- Español
- Nederlands
- Italiano
- Português

To view and update your device's language:

1. Using the left and right buttons, scroll through the Settings menu, then select **Languages** by pressing the center button.

The Languages menu opens, displaying your device's available language settings. Your device's active language is flagged with a ✓.

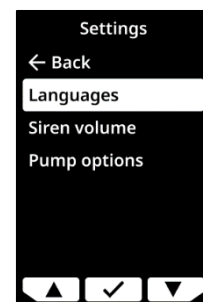

2. Using the left and right buttons, scroll through the Languages options. To select a new primary language, press the center button.
3. To exit to the Device settings menu, scroll to **Back** and select it by pressing the center button.

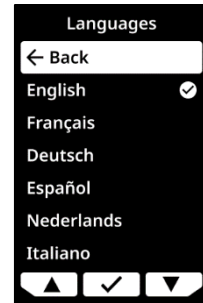

13.2 SIREN VOLUME MENU

Use the Siren volume menu to adjust the volume of EXO’s siren.

To adjust EXO’s siren volume:

1. Using the left and right buttons, scroll through the Settings menu and select **Siren volume** by pressing the center button.
2. Use the left and right buttons to select the desired volume.
3. Press ✓ to confirm.

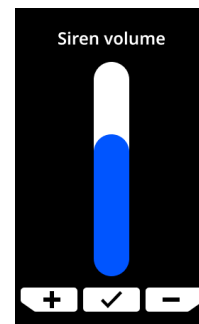
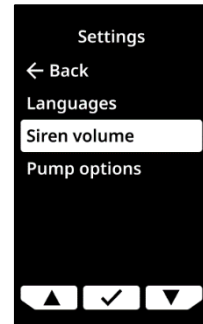

13.3 PUMP OPTIONS MENU

Use the Pump options to adjust EXO’s tube length.

13.3.1 CONFIGURING TUBE LENGTH

Tube length describes length of the tubing attached to EXO 8 pump cartridge. This value is customizable from the pump options menu, and factors into sample time.

blacklinesafety

EXO Pump supports maximum tube lengths of:

- 100 ft of 0.188" diameter tube (30.2m x 4.78mm), or
- 50 ft of 0.125" diameter tube (15.25m x 3.17mm).

To configure the tube length:

1. Using the left and right buttons, scroll through the Settings menu and select **Pump options** by pressing the center button.

The Pump options menu opens, displaying your device's available settings.



2. Using the left and right buttons, scroll through the menu and select **Tube length** by pressing the center button.

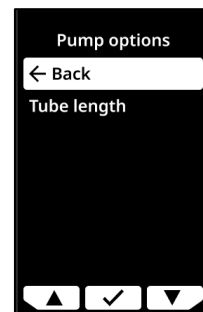

3. On the Tube length screen, use the left and right buttons to set the length fields, pressing the center button to navigate between fields:

- Select the first digit
- Select the second digit
- Set unit (m or ft)

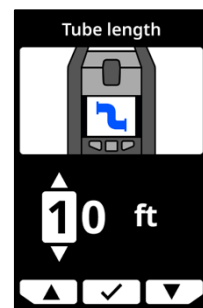

4. Select ✓ to confirm. Select ✎ to make changes to the length entered. Select ✕ to cancel the workflow and return to the Pump options menu.

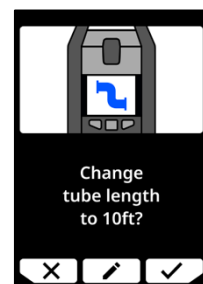

14 ADVANCED INFO MENU

Use the Advanced info menu to access advanced (read-only) device information.

To access the Advanced info menu:

1. Open the Main menu.

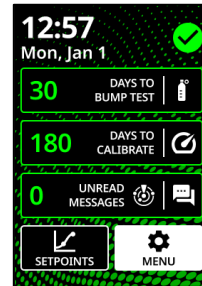

2. Select **Advanced info**.

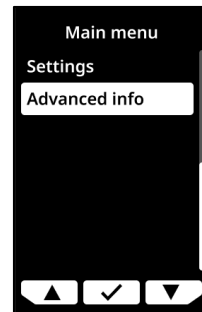

14.1 DEVICE INFO

Use Device info option to view your device's hardware and activation records, including:

- Unit ID
- Region
- Activation code
- Firmware version
- Build version
- Cartridge ID
- Cartridge version

To view device information:

1. Using the left and right buttons, scroll through the Advanced info menu, then select **Device info** by pressing the center button.

The Device info screen opens, displaying your device's settings.

2. Use the left and right buttons to scroll through the Device info screen.
3. To return to the Advanced info menu, press the center button.

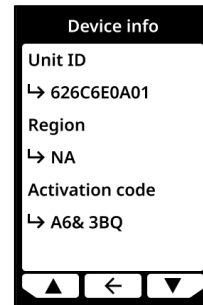

14.2 GPS LOCATION

Use the GPS location info option to view information related to your device's recorded GPS location, including:

- Time (UTC)
- Lat
- Long
- Satellites
- Signal-to-noise ratio (SNR) (dB)

To view GPS location information:

1. Using the left and right buttons, scroll through the Advanced info menu and select **GPS location** by pressing the center button.

The GPS location info screen opens.

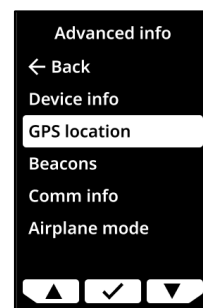

- To return to the Advanced info menu, press the center button.

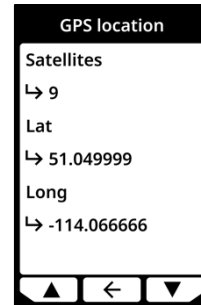

14.3 BEACONS

Use the Beacon info option to view information related to your device's location beacon communications, including:

- Beacon ID
- Power
- RSSI (Received Signal Strength Indication)
- Battery

NOTE: The Beacon information menu provides advanced information that you can use to quickly troubleshoot your device or to support the deployment of Blackline Safety's indoor location beacons.

To view beacon information:

- Using the left and right buttons, scroll through the Advanced info menu and select **Beacon info** by pressing the center button.

The Beacon info screen opens, displaying the beacons your device has communicated with.

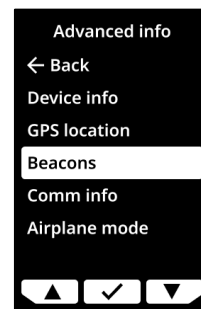

- To open the screen for a specific beacon, scroll to the beacon and press the center button.

The Beacon info screen opens, displaying information related to the selected beacon.



- 3. To return to the Advanced info menu, press the center button.

14.4 COMM INFO

Use the Communications info option to view information related to your device's cellular communications, including:

- Status (Online of Offline)
- Signal level (last sync)
- Cell provider (last sync)
- Network (last sync)

To view communication information:

- 1. Using the left and right buttons, scroll through the Advanced info menu, then select **Comm info** by pressing the center button.

The Comm info screen opens, displaying your device's communication settings.

- 2. Use the left and right buttons to scroll through the device info screen.
- 3. To return to the Advanced info menu, press the center button.

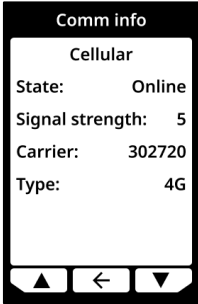
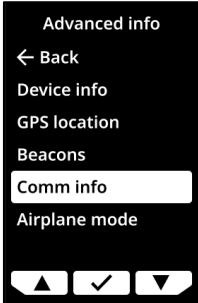

14.5 AIRPLANE MODE

To turn on airplane mode:

1. Using the left and right buttons, scroll through the Advanced info menu, then select **Airplane mode** by pressing the center button.

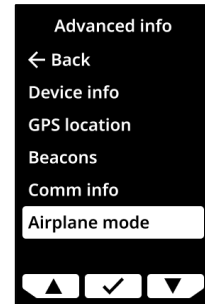

2. Select ✓ to enable airplane mode.



3. Select ✓ to confirm.
EXO restarts.

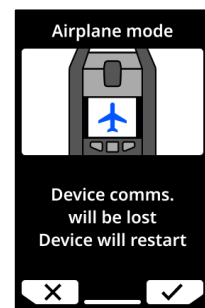

NOTE: Local time is not displayed on the Home screen when airplane mode is turned on.

To turn off airplane mode on EXO:

1. Using the left and right buttons, scroll through the Advanced info menu, then select **Airplane mode** by pressing the center button.
2. Select **Airplane mode off**.

15 ELECTRICAL PORTS

15.1 CAUTIONS



Ordinary Locations

When used in a non-Hazardous (Classified) Location, cables attached to the power port and Pins 1 and 2 of the A/B interface ports must be supplied by a Class 2 circuit, a limited energy circuit or a limited power source (LPS) as per IEC 61010-1, IEC 60950-1, or an equivalent IEC standard. The output should not exceed any of the applicable input entity parameters.

Follow local electrical codes

The wiring method used to install EXO 8's electrical port accessories should be in accordance with local electrical code. Installations are subject to acceptance by the authority having jurisdiction.

Barriers required

If the entity parameters in Diagram 15.5.4 and Diagram 15.5.5 exceed the requirements of your accessory, then a barrier is required for each interface port when EXO is in Class I, Division 1, Groups A,B,C,D location, or Class I, Zone 0/1, Group IIC location. See Diagram 15.5.6 for more information.

Intrinsic safety warning

Install EXO's electrical port accessories as shown in the electrical diagrams in sections 15.4.1 and 15.5.1 to ensure intrinsic safety.

15.2 DEFINITIONS

Low-side switch

A low-side switch completes the circuit on the ground side. It is intended to sink power rather than provide power.

U_i – Maximum input voltage

The maximum voltage (peak AC or DC) that can be applied to the connection facilities of the apparatus without invalidating the type of protection.

I_i – Maximum input current

The maximum current (peak AC or DC) that can be applied to the connection facilities of the apparatus without invalidating the type of protection.

P_i – Maximum input power

The maximum power that can be applied to the connection facilities of the apparatus without invalidating the type of protection.

C_i – Maximum internal capacitance

The maximum equivalent internal capacitance of the apparatus, which is considered as appearing across the connection facilities.

L_i – Maximum internal inductance

The maximum equivalent internal inductance of the apparatus, which is considered as appearing at the connection facilities.

U_o – Maximum output voltage

The maximum voltage (peak AC or DC) that can appear at the connection facilities of the apparatus at any applied voltage up to the maximum voltage.

I_o – Maximum output current

The maximum current (peak AC or DC) in the apparatus that can be taken from the connection facilities of the apparatus.

P_o – Maximum output power

The maximum electrical power that can be taken from the apparatus.

C_o – Maximum external capacitance

The maximum capacitance that can be connected to the connection facilities of the apparatus without invalidating the type of protection.

L_o – Maximum external inductance

The maximum value of inductance that can be connected to the connection facilities of the apparatus without invalidating the type of protection.

L_o/R_o – Maximum external inductance to resistance ratio

Maximum value of ratio of inductance to resistance that can be connected to the external connection facilities of the electrical apparatus without invalidating intrinsic safety.

15.3 EXO 8 TRANSLATOR

EXO Translator is an accessory that connects EXO to remote confined space monitoring systems and allows a central operating center service to directly monitor personnel and gas levels, access controls, and trigger alarms when necessary. For more information, see [EXO Translator Technical User Manual](#).

15.4 POWER PORT

This electrical port is where a power supply can be connected to EXO to charge its battery pack while it continues to monitor an area. Currently, two EXO accessories can be attached to this port:

- **Trickle Charger** allows EXO to be hardwired directly to a power source.
- **Solar Panel** allows EXO to be powered in remote areas through solar energy.
- ▲ **WARNING:** Cables attached to the power port are only intrinsically safe when properly set up with an electrical barrier.

Cable requirements

EXO’s power port is fitted with a male M12 4 pin plug. Electrical cables with a female M12 4 pin receptacle are required to connect to this port.

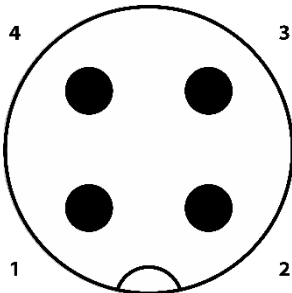

Diagram 15.4.1
Power port schematic diagram
Male plug
Pin assignment M12 plug, 4-pos., A-coded, view plug side

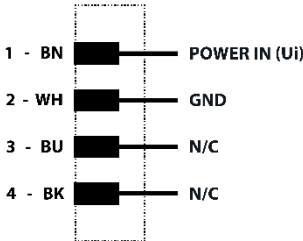

Diagram 15.4.2
Power port circuit diagram
Contact assignment of the M12 plug and M12 receptacles

15.4.1 INSTALLING ACCESSORIES

Install EXO power port accessories as shown in the following electrical diagram to ensure intrinsic safety.

Diagram 15.4.3

Power port parameters

Hazardous (Classified) Location

Class I, Division 1, Groups A,B,C,D
or
Class I, Zone 0, Group IIC

Safe (Unclassified) Location

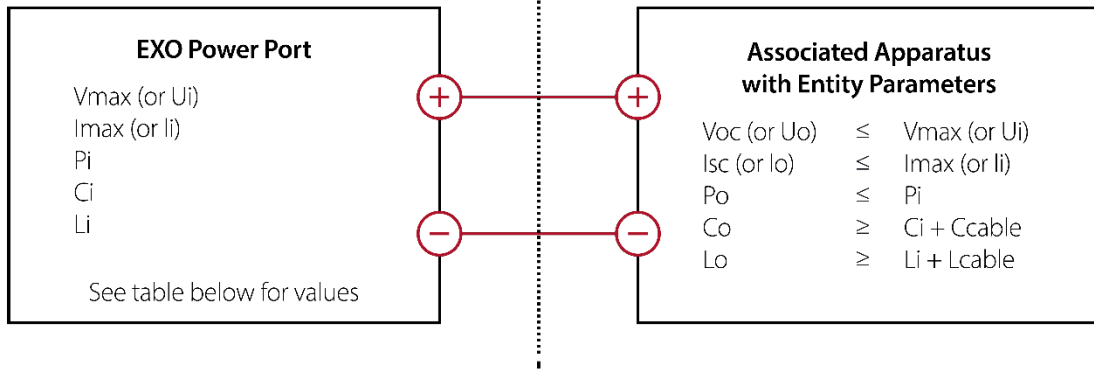

Power port input entity parameters

Terminal	Ui	Vmin	Ii	Pi	Ci	Li
Power port	16Vdc	10 Vdc	687mA	5300mW	0F	12.48uH

Functional input parameters for Power Port

Terminal	Ui	Ii	Pi	Ci	Li
Pin 1 to pin 2 (GND)	15 Vdc maximum	500mA	5300mW	0F	12.48uH

15.5 A/B INTERFACE PORTS

When events are triggered on EXO, A/B interface ports act as switches by sending ON or OFF signals to connected accessories. Ask your Blackline Safety distributor or sales representative for a list of EXO accessories that attach to the A/B interface ports.

You can configure interface ports to activate when EXO triggers a high-gas notification, low-gas notification, text message, or AlertLink message event. If an event is triggered, the port turns ON and any device connected to the port is active. The port turns OFF when the event resolves.

Interface ports can also be configured to apply or remove power from connected accessories when an event occurs. For more information on configuring interface ports, see the [Blackline Live Technical User Manual](#).

Cable requirements

Both of EXO's A/B interface ports are fitted with a female M12 4 pin receptacle. Electrical cables with a male M12 4 pin plug are required to connect to these ports.

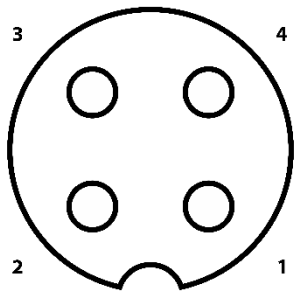

Diagram 15.5.1
Interface port schematic diagram

Female receptacle
Pin assignment M12 socket, 4-pos., A-coded, view receptacle side

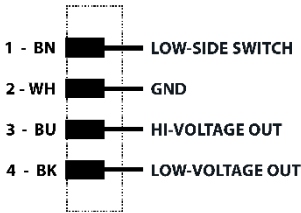

Diagram 15.5.2
Interface port circuit diagram

Contact assignment of the M12 plug and M12 receptacles

15.5.1 INSTALLING ACCESSORIES

Install EXO interface port accessories as shown in the following electrical diagrams to ensure intrinsic safety.

Diagram 15.5.3

Interface port parameters – Low-side switch

Hazardous (Classified) Location

Class I, Division 1, Groups A,B,C,D
or
Class I, Zone 0, Group IIC

Any Location Limited by Associated Apparatus Certification

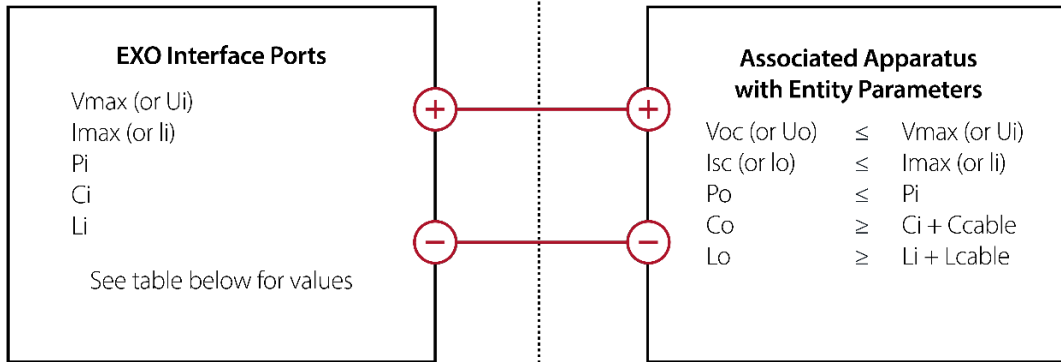

Input entity parameters (low-side switch)

Terminal	Ui	li	Pi	Ci	Li
Pin 1 to pin 2 (GND)	24Vdc	3.33A	1.25W	0F	0H

Diagram 15.5.4

Interface port parameters – pins 3 & 4

Hazardous (Classified) Location

Class I, Division 1, Groups A,B,C,D, T3
or
Class I, Zone 0, Group IIC

Any Location Limited by Associated Apparatus Certification

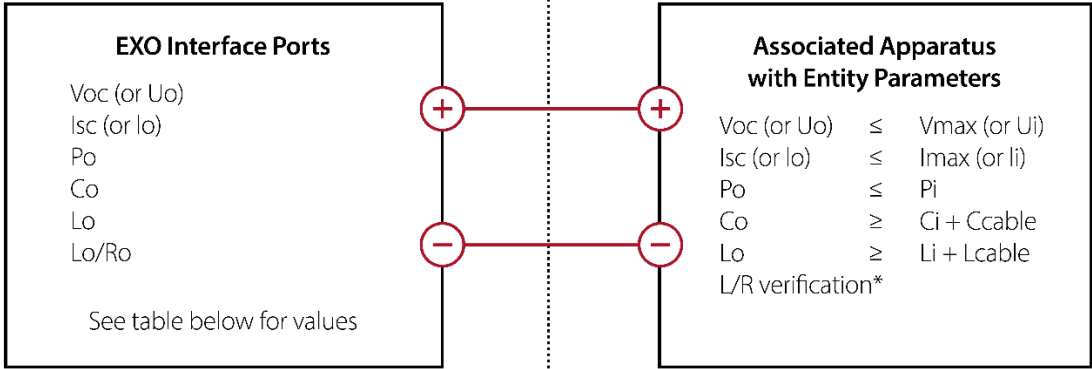

Output entity parameters

Terminal	Uo	Io	Po	Co	Lo	Lo/Ro*
Pin 3 to pin 2 (GND)	20.76Vdc	93mA	0.479W	0.194uF	4.1 mH	18.2uH/Ω
Pin 4 to pin 2 (GND)	3.6Vdc	1.21A	3W	1000uF	24.3uH	21.9uH/Ω

* Li may be greater than Lo and the cable length restrictions due to cable inductance (Lcable), and can be ignored if both of the following conditions are met:

$$Lo/Ro \geq Li/Ri$$

$$Lo/Ro \geq Lcable/Rcable$$

Diagram 15.5.5

Interface port functional parameters

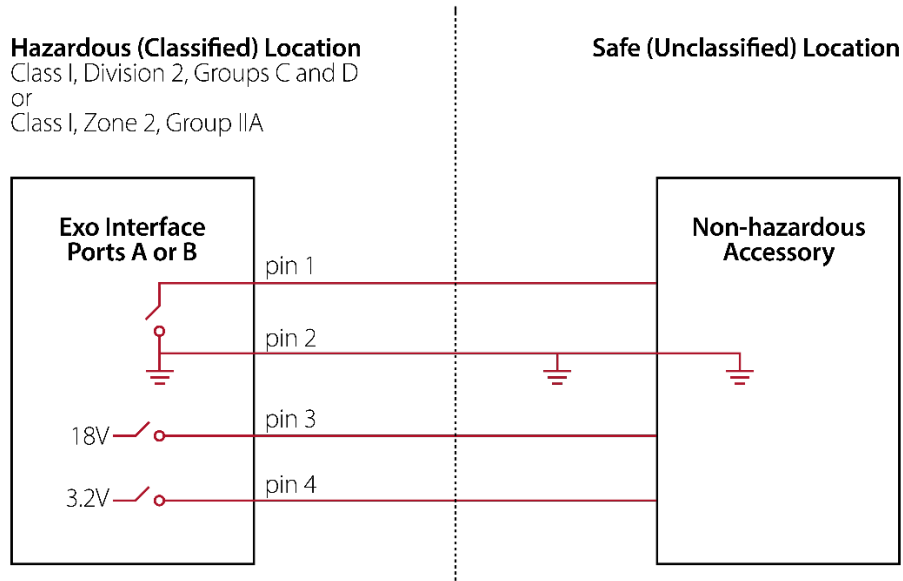

Functional output parameters for interface ports A and B

Terminal	Uo	Io [†]	Po [†]	Co	Lo
Pin 3 to pin 2 (GND)	18Vdc	48mA	479mW	0.194uF	4.1mH
Pin 4 to pin 2 (GND)	3.2Vdc	1000mA	3.0W	1000uF	24.2uH

[†]Io and Po is reduced if both pin 3 and pin 4 are used simultaneously.

Functional input parameters (low-side switch) for interface ports A and B

Terminal	Ui	Ii	Pi	CI	Li
Pin 1 to pin 2 (GND)	24Vdc	3.33A	1.25W	0F	0H

Diagram 15.5.6

Interface port functional parameters with barriers

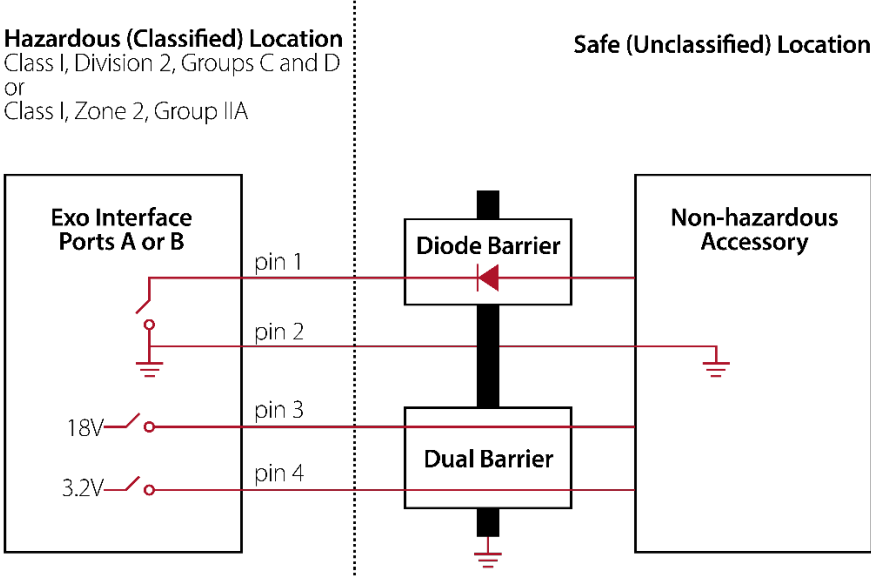

NOTE: A barrier is required for each interface port. The diode barrier and dual barrier can be individual units or a joint unit.

Functional output parameters for interface ports A and B

Terminal	Uo	Io [†]	Po [†]	Co	Lo
Pin 3 to pin 2 (GND)	18Vdc	48mA	479mW	0.194uF	4.1mH
Pin 4 to pin 2 (GND)	3.2Vdc	1000mA	3.0W	1000uF	24.2uH

[†]Io and Po is reduced if both pin 3 and pin 4 are used simultaneously.

Functional input parameters (low side switch) for interface ports A and B

Terminal	Ui	Ii	Pi	CI	Li
Pin 1 to pin 2 (GND)	24Vdc	3.33A	1.25W	0F	0H

16 OVER-THE-AIR FIRMWARE UPDATES

To offer new features, Blackline Safety periodically releases over-the-air (OTA) firmware updates. OTA firmware updates are only available when EXO 8 is on a cellular network. Firmware updates have two steps:

- Automatic download
- Automatic installation

Automatic download

When a firmware update is released, EXO downloads the update when it is on and connected to a cellular network. EXO is ready to install the firmware update when the download is complete. The download process does not interfere with normal EXO use.

Automatic installation

After the firmware is downloaded to EXO, it is automatically installed the next time EXO is powered on. The firmware installation adds 30-60 seconds to the start-up sequence.

1. Power on EXO.
 - When the green light is solid and EXO is connected, it automatically powers down.
 - The top lights flash red and yellow.
 - EXO becomes unresponsive.
 - After 30-60 seconds, EXO powers back up and displays the new firmware version.
 - EXO continues to monitor as usual.

▲ WARNING: EXO does NOT monitor when firmware is installing.

Specific information about new updates can be found on the [Blackline Support site](#). If you have any questions, please contact Blackline Technical Support [Technical Support](#).

17 SUPPORT

17.1 LEARN MORE

Visit support.blacklinesafety.com to find more support and training materials for EXO 8.

17.2 TECHNICAL SUPPORT

For technical support, please contact our Technical Support team.

North America (24 hours)

Toll Free: 1-877-869-7212 | support@blacklinesafety.com

United Kingdom (8am-5pm GMT)

+44 1787 222684 | eusupport@blacklinesafety.com

International (24 hours)

+1-403-451-0327 | support@blacklinesafety.com

18 SPECIFICATIONS

18.1 DETAILED SPECIFICATIONS

DEVICE SPECIFICATIONS	
MATERIAL	Rugged housing built from aluminum, plastic, and rubberized bumpers
WEIGHT	12.25 Kg (27 lbs)
DIMENSIONS	385 mm x 188 mm x 220 mm (15.1"x 7.4"x 8.7")
TEMPERATURE	Operating: -20°C to 50°C (-4°F to 122°F) Storage: -40°C to 60°C (-40°F to 140°F)
HUMIDITY	15 to 90% RH Non-condensing
DATA	Logging: Every minute Update interval: Every 30 minutes; instantly on high-urgency events, and every 5 seconds until event cleared
APPROVALS/STANDARDS	RoHS, CE Canada & USA: Class I Division 1 Group A,B,C,DT3; Class I Zone 0 AEx ia IIC T3; Ex ia IIC T3 Ga IECEX: Ex ia IIC T3 Ga ATEX: Ex ia IIC T3 Ga LEL Performance: CSA C22.2 No.152; ISA 12.13.01
IP RATING	IP66
SOUND LEVELS	Sounder db rating: 110 dB @ 30 cm (12 inches) Speaker db rating: 63 db @ 30 cm (12 inches)
SENSORS	Standard: 4 sensors, up to 5 gases Optional gas expansion module: 8 sensors, up to 8 gases
WARRANTY	Three-year hardware warranty, extended warranty available. Blackline complete lease option provides comprehensive warranty for full term.
SALT FOG TEST	Compliant to MIL-STD-801 509

OPTIONAL PUMP CONFIGURATION	
CHANNELS	4
OPERATING TEMPERATURE	-20°C to 50°C (-4°F to 122°F)
SAMPLE LENGTH	Up to 30 m (100 ft)

USER INTERFACE	
DISPLAY	Dual 3.4" diagonal, 272 by 451 pixel, 64-color liquid crystal displays (LCD)
BUTTONS	Menu system: Driven by three-button keypad Power button: On/off
SOS LATCH	Send SOS alert
LANGUAGES	Multi-language support: EN, FR, ES, DE, IT, NL, PT

CONNECTIVITY	
LOCATION AWARENESS	Multi-constellation: GPS/QZSS, Galileo, BeiDou Receiver type: 72-channel Assisted-GNSS: Yes GNSS Accuracy: 5 m (16 feet), CEP 50%, 24 hours static Optional Beacon for indoor location accuracy
CELLULAR	Wireless coverage: 219 countries, 381 Operators 4G LTE bands: 1, 12, 13, 18, 19, 2, 20, 26, 28, 3, 38, 39, 4, 40, 41, 5, 7, 8 3G UMTS bands: 1900, 2100, 850, 900 2G GSM bands: 850/900/1800/1900 Antenna: Internal
SATELLITE	Optional satellite module for connecting to the Iridium satellite network Radio: 1621 MHz, 2 Watts Antenna: Internal
BLUETOOTH	(4.2 BR/BLE)
WIRELESS UPDATES	Over-the-air device configurations Over-the-air firmware upgrades
OPTIONAL PTT	Send and receive voice messages to other G7 and EXO devices

BATTERY AND CHARGING	
RECHARGEABLE BATTERY	144 Ah (LiFePO4)
CHARGE TIME	~12 hours
BATTERY LIFE	Battery life in diffusion mode: 100 days at 20°C (68°F), LEL-MPS, H2S, CO and O2 configuration Battery life in pump mode: 30 days at 20°C (68°F), LEL-MPS, H2S, CO and O2 configuration

GAMMA SENSOR	
TYPE	Scintillation crystal
RANGE	1-200,000 µRem/hr (0.01-2,000 µSv/hr)
MEASUREMENT	µRem/hr or µSv/hr
CALIBRATION	Factory calibrated
LIFESPAN	> 10 years
WEIGHT	345 grams (12 ounces)

INTERFACE PORTS

A/B

Intrinsically safe, configurable external signal ports designed to integrate with external alarms and electrical systems
Four pins per interface port

GAS CARTRIDGE AND SENSORS

GAS	SENSOR TYPE	RANGE	RESOLUTION
AMMONIA (NH ₃)	Electrochemical	0–100 ppm	0.1 ppm
CARBON DIOXIDE (CO ₂)	NDIR	0–50,000 ppm	50 ppm
CARBON MONOXIDE (CO)	Electrochemical	0–500 ppm	1 ppm
CHLORINE (CL ₂) ¹	Electrochemical	0–20 ppm	0.1 ppm
CHLORINE DIOXIDE (CLO ₂) ¹	Electrochemical	0–2 ppm	0.01 ppm
COSH (CO & H ₂ S)	Electrochemical	0–500 ppm CO and 0–200 ppm H ₂ S	1 ppm CO and 0.1 ppm H ₂ S
HIGH-RANGE AMMONIA (NH ₃)	Electrochemical	0–500 ppm	1 ppm
HIGH-RANGE CARBON MONOXIDE (CO)	Electrochemical	0–2000 ppm	1 ppm
HIGH-RANGE HYDROGEN SULFIDE (H ₂ S)	Electrochemical	0–500 ppm	0.5 ppm
HYDROGEN (H ₂) (UK/EU ONLY)	Electrochemical	0–40,000 ppm	1% LEL (400 ppm H ₂)
HYDROGEN CYANIDE (HCN) ^{1,4}	Electrochemical	0–30 ppm	0.1 ppm
HYDROGEN FLUORIDE (HF) ⁴	Electrochemical	0–10 ppm	0.1 ppm
HYDROGEN RESISTANT CARBON MONOXIDE (CO-H)	Electrochemical	0–500 ppm	1 ppm
HYDROGEN SULFIDE (H ₂ S)	Electrochemical	0–100 ppm	0.1 ppm
LEL - INFRARED (LEL-IR)	NDIR	0–100% LEL	1% LEL
LEL- MOLECULAR PROPERTY SPECTROMETER (LEL-MPS) ³	MPS	0–100% LEL	1% LEL
NITROGEN DIOXIDE (NO ₂)	Electrochemical	0–50 ppm	0.1 ppm
OXYGEN (O ₂)	Pumped electrochemical	0–25% vol	0.1% vol
OZONE (O ₃) ⁴	Electrochemical	0.1 ppm	0.1 ppm
PHOTOIONIZATION (PID)	PID	0–4,000 ppm	Variable ² , lowest 0.1 ppm
SULFUR DIOXIDE (SO ₂)	Electrochemical	0–100 ppm	0.1 ppm

¹ Sensor not compatible with pump configuration.

² Dependent on correction factor.

³ Operating Pressure: 80 to 120 kPa (11.6 to 17.4 psi).

⁴ Compatible with gas expansion module coming soon.

NOTE: Check with Blackline for approval status. All specifications subject to change.

19 LEGAL NOTICES AND CERTIFICATIONS

19.1 LEGAL NOTICES

Information in this document is subject to change without notice. This document is provided "as is" and Blackline Safety Corp. ("Blackline") and its affiliated companies and partners assume no responsibility for any typographical, technical, or other inaccuracies in this document. Blackline reserves the right to periodically change information that is contained in this document. However, Blackline makes no commitment to provide any such changes, updates, enhancements, or other additions to this document to you in a timely manner or at all.

Copyright © 2024 Blackline Safety Corp. All rights reserved.

Except as expressly provided herein, no part of this manual may be reproduced, copied, transmitted, disseminated, downloaded, or stored in any storage medium, for any purpose without the express prior written consent of Blackline Safety Corp ("Blackline"). Blackline hereby grants permission to download a single copy of this manual onto some form of electronic storage medium to be viewed and to print one copy of this manual or any revision hereto, provided that such electronic or printed copy of this manual must contain the complete text of this copyright notice. Further, any unauthorized commercial distribution of this manual or any revision hereto is strictly prohibited.

The Blackline, Alert, Locate, Respond, Families of related marks, images, and symbols, including Blackline, G7, G7c, G7x, EXO, LiveResponse, Loner, LonerIS, Loner IS+, Loner M6, Loner M6i, Loner Mobile, Loner 900, and SureSafe are the exclusive properties and trademarks of Blackline Safety Corp. All other brands, product names, company names, trademarks and service marks are the properties of their respective owners.

Warranty

Your EXO device is warranted against defects in materials and workmanship for up to three years from date of purchase. For further details regarding your Blackline warranty, please refer to your terms and conditions of service.

FCC Compliance

This device complies with part 15 of the FCC Rules. Operation is subject to the following two conditions: (1) This device may not cause harmful interference, and (2) this device must accept any interference received, including interference that may cause undesired operation.

NOTE: The grantee is not responsible for any changes or modifications not expressly approved by the party responsible for compliance. Such modifications could void the user's authority to operate the equipment.

NOTE: This equipment has been tested and found to comply with the limits for a Class A digital device, pursuant to part 15 of the FCC Rules. These limits are designed to provide reasonable protection against harmful interference when the equipment is operated in a commercial environment. This equipment generates, uses, and can radiate radio frequency energy and, if not installed and used in accordance with the instruction manual, may cause harmful interference to radio communications. Operation of this equipment in a residential area is likely to cause harmful interference, in which case the user will be required to correct the interference at his own expense.

This device is compliant with radio frequency radiation exposure regulations for mobile devices. As such, a separation of at least 20 cm must be normally maintained between the device and nearby persons.

Industry Canada Compliance

This device complies with Industry Canada license-exempt RSS standard(s). Operation is subject to the following two conditions: (1) this device may not cause interference, and (2) this device must accept any interference, including interference that may cause undesired operation of the device.

Notification d'Industrie Canada

Ce dispositif est conforme au(x) format(s) RSS libre(s) d'Industrie Canada. Son fonctionnement est assujéti aux deux conditions suivantes : (1) Cet appareil ne peut causer d'interférences nuisibles, et (2) cet appareil doit accepter toute interférence reçue, y compris les interférences pouvant provoquer un mauvais fonctionnement du dispositif.

Warning

Do not operate Blackline Safety products where you are not able to safely operate your mobile/cellular phone.

Electrical equipment may be hazardous if misused. Operation of this product, or similar products, must always be supervised by an adult. Do not allow children access to the interior of any electrical product and do not permit them to handle any cables.

Do not operate or store Blackline products outside their specified operating or storage temperatures. Consult 13 for more information.

Blackline products may contain an internal lithium-ion battery pack. Seek advice from your local electronics recycling authority regarding the disposal of your device. Do not dispose of Blackline products in your household trash.

19.2 INTRINSICALLY SAFE CERTIFICATION

Intrinsically Safe

This device is certified Intrinsically Safe for use in Class I Division 1 Groups A,B,C,D T3; Ex ia IIC T3 Ga; Class I Zone 0 AEx ia Group IIC T3 Ga hazardous (classified) locations.

MC 267256

UL 60079

Class I Division 1 Groups A,B,C,D; T3

Class I Zone 0 AEx ia IIC T3 Ga

CAN/CSA C22.2 No. 60079

Ex ia IIC T3 Ga



IECEX/ATEX/UKCA: IECEX SIR 20.0022X; Sira 20ATEX2004X; CSAE

21UKEX2218X

IEC 60079; EN 60079

Ex ia IIC T3 Ga



-20°C ≤ T_{amb} ≤ +50°C

Base unit P/N: EX8b-cc-dde

Where b is the model code and cc-dde is the regional code.

Caution

For safety reasons this equipment must be operated and serviced by qualified personnel only. High off-scale readings may indicate explosive concentration.

The equipment shall only be charged when in the non-hazardous area using a charger specifically supplied for use with the unit (for example part number JAC2504L-XX, manufactured by Schauer Battery Chargers), approved as SELV or Class 2 equipment against IEC 60950, IEC 61010-1 or an equivalent IEC standard. The maximum voltage and current from the charger shall not exceed 5Vdc and 25A respectively.

The enclosure is manufactured from Aluminium, magnesium, titanium or zirconium which may be used at the accessible surface of the equipment. In rare cases, ignition sources due to impact and friction sparks could occur. This shall be considered when EXO is being installed in Zone 0 locations for group II level of protection Ga.

Consult with your organization's safety professional for further information regarding the topic of intrinsic safety and any policies, procedures, facilities, or locations within facilities that may be related to intrinsic safety.

Sécurité intrinsèque

Cet appareil est certifié à sécurité intrinsèque pour l'usage en classe I division 1 groupe A,B,C,D T3; Ex ia IIC T3 Ga; classe I zone 0 AEx ia groupe IIC T3 Ga dans les lieux classés comme dangereux.

Standards:

CAN/CSA C22.2 No. 60079-0: 2019

CAN/CSA C22.2 No. 60079-11: 2014

CSA/C22.2 No. 60079-29-1:17 AMD 1

C22.2 No. 152 - M1984 (R2011)

UL 913, Eighth Edition

UL 60079-0: Sixth Edition

UL 60079-11: Sixth Edition

ANSI/ISA 12.13.01: 2000

EN 60079-0: 2018

EN 60079-11: 2012

IEC 60079-0: 2011 6th Edition

IEC 60079-11: 2011 6th Edition

Attention

Pour des raisons de sécurité, cet équipement doit être utilisé, entretenu et réparé uniquement par un personnel qualifié. Des lectures supérieures à l'échelle peuvent indiquer des concentrations explosives.

L'équipement ne doit être chargé que dans la zone non dangereuse à l'aide d'un chargeur spécifiquement fourni pour l'utilisation avec l'appareil (par exemple, la référence JAC2504L-NA, fabriquée par Schauer Battery Chargers) SELV ou Classe 2 selon IEC 60950, IEC 61010-1 ou une norme IEC équivalente. La tension et le courant maximum du chargeur ne doivent pas dépasser respectivement 5Vdc et 25A.

S'il vous plaît consulter un professionnel de la sécurité de votre organisation pour de plus amples informations concernant le sujet de la sécurité intrinsèque et les politiques, les procédures, les installations, ou emplacements au sein des établissements qui peuvent être liés à la sécurité intrinsèque.

19.3 INMETRO CERTIFICATION

INMETRO - Certificate BRA 22.GE0002X, Ex ia IIC T3 Ga

This product is not suitable for use in domestic environments, as it may cause electromagnetic interference that requires the user to take necessary measures to minimize such interference.

19.4 LEL FUNCTIONAL SAFETY

All outputs and alarms are described. More detailed information on each alarm can be found in the manual. The alarm outputs on the cartridge are the highest priority and must be followed. Cartridge notifications have precedence over any other notifications from the device.

Device Start-up Self-Test

On device startup, the device performs a self-test sequence which exercises the device lights and audio. Verify functionality of all device outputs by confirming that all lights turn on and audio can be heard.

Calibration Protection

When a calibration is started, the cartridge will suppress LEL high gas detection and notifications, and the yellow light will flash every 30 seconds. The maximum amount of time the cartridge can stay in the calibration mode is 5 minutes. When calibration has finished, or 5 minutes have expired, the yellow light will stop flashing.

Calibration Sequence

Monitor the gas readings on the screen during calibration and verify that the concentrations reach the target gas concentrations (50% LEL for LEL).

Muting

Alarms on the device can be muted by holding the up/down arrow buttons for 3 seconds. An alarm will not be muted if the buttons are not held down for the entire 3 second duration.

Gas Alarm Muting

LEL high gas notifications can be muted for 60 seconds every 2 minutes when the gas threshold exceeds 60% LEL. Additional muting requests will be ignored, and the audible and visual alert patterns will continue.

Non-Gas Alarm Muting

Non gas alarms such as low battery can be muted using the standard muting procedure.

Gas Detection

T90 for LEL gas detection will be under 50 seconds in the worst case.

Secondary Modes

If a secondary mode is entered when LEL notifications are disabled, the yellow light will flash every 30 seconds to indicate that gas notifications are being suppressed.

MPS Automatic Zeroing

EXO will prompt the user to acknowledge that it is performing an automatic zeroing on startup. If you do not acknowledge the prompt by pressing OK within 15 seconds, the device will display a sensor error notification.

Test Pattern

When EXO is performing an automatic assessment during calibration, the cartridge will suppress light operation for a maximum of 5 seconds. During this time, only the audible assessment will be performed.

Shutdown

To initiate shutdown, press the power button for 3 seconds. The device will beep once and double flash the yellow lights. When the green light is completely off, the device is not detecting gas.

Standards

CAN/CSA C22.2 No. 60079-29-1:2017

UL 60079-29-1:2019

Fault States and Output

Low Battery: Indicated by yellow light flashing and audible by piezo. Standard warning pattern applied on both. Indicator will activate within 120s of battery being low. The device will run for at least 10 minutes in low battery mode.

Self-Test Failure: All errors including memory tests, sensor tests and watchdog tests are indicated by yellow light flashing and audible by piezo.

Sensor Communication Failure: Indicated by yellow light flashing and audible by piezo. Standard warning pattern applied on both.

Under Limit Detected: Indicated by yellow light flashing and audible by piezo.

Tous les résultats et alarmes sont décrits. Des informations plus détaillées sur chaque alarme se trouvent dans le manuel. Les sorties d'alarme de la cartouche sont prioritaires et doivent être prises en compte. Les notifications de la cartouche ont la priorité sur toutes les autres notifications de l'appareil.

Auto-test de démarrage du dispositif

Lors du démarrage du dispositif, celui-ci effectue une séquence d'auto-test qui met en service les LED et l'audio du dispositif. Vérifiez le bon fonctionnement de toutes les sorties du dispositif.

Protection de l'étalonnage

Lorsqu'un étalonnage est lancé, la cartouche supprimera la détection et les alertes de gaz LEL élevé, et la lumière jaune clignotera toutes les 30 secondes. La durée maximale pendant laquelle la cartouche peut rester en mode d'étalonnage est de 5 minutes. Lorsque l'étalonnage est terminé, ou que 5 minutes se sont écoulées, la lumière jaune cessera de clignoter.

Séquence d'étalonnage

Surveillez les lectures de gaz à l'écran pendant l'étalonnage et vérifiez que les concentrations atteignent les concentrations cibles de gaz (50 % LEL pour LEL).

Mise en sourdine

Les alarmes de l'appareil peuvent être désactivées en maintenant les flèches haut/bas enfoncées pendant 3 secondes. L'alarme ne sera pas désactivée si les boutons ne sont pas maintenus enfoncés pendant ces 3 secondes.

Mise en sourdine de l'alarme de gaz

Les alertes de gaz LEL élevé peuvent être mises en sourdine pendant 60 secondes toutes les 2 minutes lorsque le seuil de gaz dépasse 60 % LEL. Les demandes de mise en sourdine supplémentaires seront ignorées, et les modèles d'alerte sonore et visuelle continueront.

Désactivation des alarmes non liées au gaz

Les alarmes non liées au gaz, telles que les alarmes de batterie faible, peuvent être désactivées à l'aide de la procédure de désactivation standard.

Modes secondaires

Si un mode secondaire est activé lorsque les alertes LEL sont désactivées, la lumière jaune clignotera toutes les 30 secondes pour indiquer que les alertes de gaz sont supprimées.

Auto-zéro MPS

L'EXO demandera à l'utilisateur de reconnaître qu'il effectue un auto-zéro au démarrage. Si vous ne reconnaissez pas l'auto-zéro en appuyant sur OK dans les 15 secondes, le dispositif affichera une alerte d'erreur de capteur.

Motif de test

Lorsque l'EXO effectue une évaluation automatique pendant l'étalonnage, la cartouche supprimera le fonctionnement de la lumière pendant un maximum de 5 secondes. Pendant ce temps, seule l'évaluation sonore sera effectuée.

Normes :

CAN/CSA C22.2 No. 60079-29-1:2017

UL 60079-29-1:2019

États de défaillance et sorties

Batterie faible : indiquée par le clignotement de la LED jaune et un signal sonore émis par le buzzer. Le modèle d'avertissement standard est appliqué aux deux. L'indicateur s'active dans les 120 secondes suivant l'état de batterie faible. L'appareil fonctionnera pendant au moins 10 minutes en mode batterie faible.

Échec de l'auto-test : toutes les erreurs, y compris les tests de mémoire, les tests de capteurs et les tests du chien de garde, sont indiquées par le clignotement de la LED jaune et un signal sonore émis par le buzzer. Le modèle d'avertissement standard est appliqué aux deux.

Échec de la communication du capteur: indiqué par le clignotement de la LED jaune et audible par le buzzer. Modèle d'avertissement standard appliqué aux deux.

Détection sous la limite : indiquée par le clignotement de la LED jaune et audible par le buzzer. Modèle d'avertissement standard appliqué aux deux.