



---

# USER MANUAL

# Spot Thermal Camera

MODELS TG298 and TG268







---

# **USER MANUAL**

## **Spot Thermal Camera**



# Table of contents

---

<b>1</b>	<b>Advisories</b> .....	<b>1</b>
	1.1 Copyright.....	1
	1.2 Quality Assurance .....	1
	1.3 Documentation .....	1
	1.4 Disposal of Electronic Waste.....	1
<b>2</b>	<b>Introduction</b> .....	<b>2</b>
<b>3</b>	<b>Safety</b> .....	<b>3</b>
	3.1 Safety Warnings and Cautions.....	3
<b>4</b>	<b>Description</b> .....	<b>4</b>
	4.1 Product Description.....	4
	4.2 Control Button Descriptions .....	5
	4.3 Display Description .....	6
<b>5</b>	<b>Battery Power</b> .....	<b>7</b>
	5.1 Battery Power Basics .....	7
	5.2 Auto Power OFF.....	7
<b>6</b>	<b>Camera Ergonomics</b> .....	<b>8</b>
<b>7</b>	<b>Menu Reference Map</b> .....	<b>9</b>
<b>8</b>	<b>Thermal IR Camera</b> .....	<b>11</b>
	8.1 Thermal Camera Basics.....	11
	8.2 Thermal Camera Operation .....	12
	8.3 Distance-to-Spot Ratio.....	14
<b>9</b>	<b>Visual Spectrum Camera</b> .....	<b>15</b>
	9.1 Visual Camera Basics.....	15
	9.2 Visual Camera Operation .....	15
<b>10</b>	<b>Image Capture</b> .....	<b>17</b>
<b>11</b>	<b>Menu System</b> .....	<b>18</b>
	11.1 Main Menu Basics .....	18
	11.2 GALLERY Menu.....	18
	11.2.1 IMAGE FILES submenu.....	19
	11.2.2 LOG RESULTS submenu.....	20
	11.3 IMAGE ADJUSTMENTS Menu .....	23
	11.3.1 IMAGE MODES submenu.....	23
	11.3.2 COLORS submenu .....	25
	11.3.3 MEASUREMENT submenu .....	27
	11.4 LOGGING Menu .....	29

## Table of contents

---

	11.4.1	TEMP SPOT Submenu .....	30
	11.4.2	TIME LAPSE IMAGING Submenu.....	31
	11.4.3	VIDEO Submenu .....	32
	11.4.4	ALARM Submenu .....	33
	11.5	LIGHT Menu (Worklight) .....	33
	11.6	SETTINGS Menu.....	34
	11.6.1	DEVICE SETTINGS Submenu .....	34
	11.6.2	GENERAL SETTINGS Submenu.....	37
<b>12</b>		<b>Condition Monitoring (Logging) .....</b>	<b>40</b>
	12.1	Condition Monitoring Overview .....	40
	12.2	Condition Monitoring Tools .....	40
	12.3	Condition Monitoring — TEMP SPOT menu .....	41
	12.4	Condition Monitoring — TIME LAPSE IMAGING Menu .....	43
	12.5	Condition Monitoring — VIDEO Menu .....	45
	12.6	Condition Monitoring — ALARM Menu .....	47
<b>13</b>		<b>High Temperature Switch (TG298) .....</b>	<b>48</b>
<b>14</b>		<b>Type-K Thermocouple Measurements (TG268 Only) .....</b>	<b>49</b>
<b>15</b>		<b>Bluetooth Communication and METERLiNK .....</b>	<b>51</b>
	15.1	Communication Overview.....	51
	15.2	Download METERLiNK.....	51
	15.3	Setting up METERLiNK.....	51
	15.4	Share Images using Bluetooth .....	51
	15.5	Using the FLIR Ignite® Cloud.....	53
	15.6	FCC Compliance .....	53
<b>16</b>		<b>PC Interface.....</b>	<b>54</b>
<b>17</b>		<b>Field Firmware Updates .....</b>	<b>55</b>
	17.1	System Firmware Update .....	55
<b>18</b>		<b>Maintenance .....</b>	<b>56</b>
	18.1	Cleaning .....	56
	18.2	Battery Considerations and Service .....	56
	18.3	Reset the Camera.....	56
<b>19</b>		<b>Specifications.....</b>	<b>57</b>
	19.1	Imaging and Optical Specifications .....	57
	19.2	Detector Specifications .....	57
	19.3	Image Presentation Specifications.....	57

## Table of contents

---

19.4	Measurement Specifications .....	58
19.5	Measurement Analysis Specifications .....	59
19.6	Type-K Specifications (TG268 only) .....	59
19.7	Configuration Specifications.....	59
19.8	Image, Video, and Data Log Storage Specifications .....	59
19.9	Digital Camera Specifications.....	60
19.10	Worklight Specifications .....	60
19.11	Laser Pointer Specifications.....	60
19.12	Data Communication and Interface Specifications .....	60
19.13	Battery Specifications.....	61
19.14	Environmental Specifications .....	61
19.15	Physical Specifications .....	62
19.16	Included Equipment .....	62
<b>20</b>	<b>Limited 10-Year Warranty.....</b>	<b>63</b>
<b>21</b>	<b>Customer Support.....</b>	<b>64</b>



# 1 Advisories

---

## 1.1 Copyright

© 2025 FLIR Systems, Inc. All rights reserved worldwide.

No parts of the software including source code may be reproduced, transmitted, transcribed or translated into any language or computer language in any form or by any means, electronic, magnetic, optical, manual or otherwise, without the prior written permission of FLIR.

The documentation must not, in whole or part, be copied, photocopied, reproduced, translated or transmitted to any electronic medium or machine-readable form without prior consent, in writing, from FLIR Systems, Inc. Names and marks appearing on the products herein are either registered trademarks or trademarks of FLIR Systems, Inc. and/or its subsidiaries. All other trademarks, trade names or company names referenced herein are used for identification only and are the property of their respective owners.

## 1.2 Quality Assurance

The Quality Management System under which these products are developed and manufactured has been certified in accordance with the ISO 9001 standard. FLIR Systems, Inc. is committed to a policy of continuous development; therefore, we reserve the right to make changes and improvements on any of the products without prior notice.

## 1.3 Documentation

To access the latest manuals and notifications, go to the Download tab at: <https://support.flir.com>. It only takes a few minutes to register online. In the download area you will also find the latest releases of manuals for our other products, as well as manuals for our historical and obsolete products.

## 1.4 Disposal of Electronic Waste



As with most electronic products, this equipment must be disposed of in an environmentally friendly way, and in accordance with existing regulations for electronic waste. Please contact your FLIR representative for more details.

# 2 Introduction

---

The FLIR spot thermal cameras combine non-contact spot temperature measurements and thermal imaging in one troubleshooting tool to help quickly locate sources of heat and potential faults.

These cameras include condition monitoring tools where images and data logs can be automatically captured at programmable intervals for later analysis. The condition monitoring video feature logs readings while recording video. These tools can help predict and prevent equipment failures.



The TG298 offers a high temperature switch for non-contact measurements up to 1976°F (1080°C), and the TG268 includes a Type-K thermocouple input for contact measurements.

## Features

- True thermal imaging Lepton® microbolometer with integrated shutter.
- Visual spectrum digital camera with high resolution mode.
- MSX® (Multi-Spectral Dynamic Imaging) image mode that adds key details from the visual spectrum to the thermal image.
- Condition monitoring tools.
- Adjustable emissivity.
- High power worklight.
- Laser pointer and cross-hairs (center spot) for precise targeting.
- 8 GB internal memory for storing images, videos, and data logs.
- USB-C connectivity for data sharing, charging, and updating.
- Bluetooth® temperature monitoring and data sharing using METERLiNK®.
- Easy to read TFT color LCD.
- Intuitive multilingual menu system.
- IP54 rated enclosure (with top flap closed).
- Rechargeable lithium battery.
- Adjustable auto power off (APO).
- Accessory mounting for tripods and other attachments.

# 3 Safety

## 3.1 Safety Warnings and Cautions

	<b>WARNING</b>
<p>This symbol  indicates that the user must refer to the user manual for further information.</p> <p>The instrument's IP54 rating applies when the top flap is completely sealed. Do not operate the instrument with the flap open, except for charging, PC interface, or Type-K thermocouple use.</p>	

	<b>CAUTION</b>
<p>Use of controls or adjustments or performance of procedures other than those specified herein may result in hazardous radiation exposure.</p> <p>Use extreme caution when the laser pointer is on.</p> <p>Do not point the laser beam toward anyone's eye or allow the beam to strike the eye from a reflective surface.</p> <p>Do not use the laser near explosive gases or in other potentially explosive areas.</p> <p>Refer to the CAUTION statement label (shown below) for critical safety information.</p>	
<div style="background-color: #FFD700; padding: 5px;"><p><b>CLASS 1 LASER PRODUCT</b> <b>IEC 60825-1:2014</b></p><p><small>IT COMPLIES WITH 21 CFR 1040.10 AND 1040.11 EXCEPT FOR CONFORMANCE WITH IEC 60825-1 Ed.3, AS DESCRIBED IN LASER NOTICE NO.56, DATED MAY 8, 2019</small></p></div>	

## NOTE

- When measuring or charging for extended periods, the device's internal temperature can rise and impact the spot thermal sensor accuracy. Allow cool-down time between extended measurement and charging sessions.
- Using the device in areas where the ambient temperature is 113°F (45°C) for extended periods might affect the device's performance.

# 4 Description

---

## 4.1 Product Description

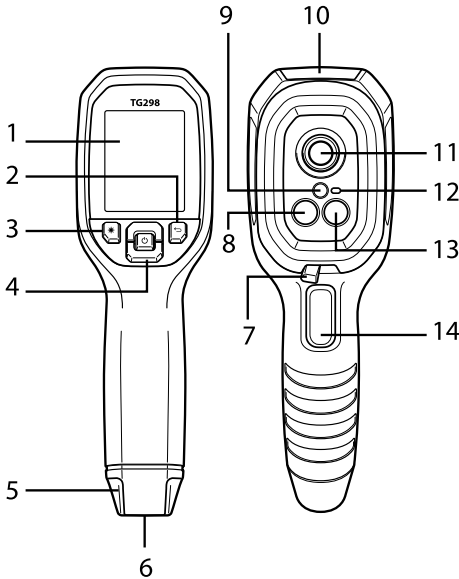





**Figure 4.1** Imaging IR Thermometer Description (TG298 pictured)

1. TFT color display.
2. Return button (revert to previous screen).
3. Laser pointer button.
4. Up/Down navigation buttons and Power/Menu button.
5. Lanyard post.
6. Accessory mount.
7. High temperature switch (TG298).
8. Lepton IR camera lens.
9. Laser pointer lens.
10. USB-C and thermocouple (TG268) connections.
11. Spot thermal sensor.
12. Worklight.
13. Visual spectrum camera lens.
14. Trigger to capture images, start/stop logging, and to exit menu.

---

## 4.2 Control Button Descriptions

	<p>Power and Menu button:          Long press to power ON/OFF.          When ON, short press to access the main menu.          In menus, press to select, toggle, and confirm settings.</p>
	<p>Return button: Return to previous screen.</p>
	<p>Up arrow button:          Scroll up in the menus.          Increase settings in menus.          Align visual and thermal images in MSX mode.</p>
	<p>Down arrow button:          Scroll down in menus.          Decrease settings in menus.          Align visual and thermal images in MSX mode.</p>
	<p>Laser pointer button (laser must be enabled in menu).          Press and hold to activate laser.</p>
<p><b>TRIGGER</b></p>	<p>Capture camera image.          Start/stop logging, time lapse imaging, and video recording.          Exit the menu system.</p>

### 4.3 Display Description

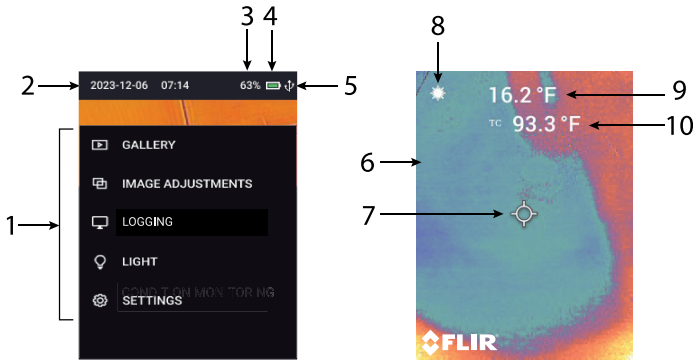

**Figure 4.2** Display Description

1. Main menu (press Menu button to access).
2. Date and time.
3. Battery status percentage.
4. Battery status indicator.
5. USB and Bluetooth icons appear here when active.
6. Camera image.
7. Center spot cross-hairs.
8. Laser pointer active.
9. Targeted temperature measurement.
10. Thermocouple measurement (TG268).

# 5 Battery Power

---

## NOTE

To comply with international transportation regulations, the meter is shipped with its battery charged to a maximum of 30%. The meter may show a low battery alert when it is received, it is recommended that the battery be charged to 100% before use.

### 5.1 Battery Power Basics

Power is supplied by an internal rechargeable lithium battery. Long press the Power/Menu button  to switch the camera ON or OFF.

If the camera does not switch ON, charge the battery by connecting the camera to an AC charger using the supplied USB-C cable. The USB-C jack is located in the top compartment. Do not use the camera while it is charging.

See Section 18.2, *Battery Considerations and Service*, for additional battery information.

### 5.2 Auto Power OFF

When Auto Power OFF is enabled, it switches the camera OFF automatically if no buttons are pressed after a specified length of time (5, 15, or 30 minutes). Section 11.6.1 explains how to set the timer and how to disable it.

Auto Power OFF is automatically disabled when any of the logging functions are active (data logging, time lapse imaging, and video recording).

# 6 Camera Ergonomics

---

In typical use, the camera's ergonomic design allows you to hold it comfortably in either hand, while controlling the trigger with your index finger, and pressing the buttons with your thumb.

The camera's display is conveniently positioned above the control buttons, and the brightness can be adjusted in the Device Settings menu (Menu button > *SETTINGS* > *DEVICE SETTINGS*).

The camera lenses (IR camera, spot temperature sensor, and laser pointer) are positioned on the opposite side of the display. Avoid touching or otherwise obstructing the lenses.

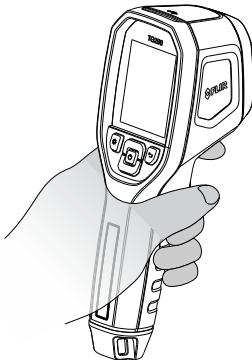

**Figure 6.1** Ergonomically designed for one-hand operation.

# 7 Menu Reference Map

This map can be used as a quick reference and overview of the entire menu system. See Section 11 for detailed instructions on each menu item.

- Short press the Menu button to access the main menu.
- Use the arrow buttons to scroll.
- Use the Menu button to select, toggle, or confirm settings.
- Use the Return button to return to the previous screen.
- Use the trigger to exit the menu.
- The menu is locked when the USB cable is connected to the camera.

MAIN MENU	SUB MENU 1	SUB MENU 2	ACTION	
<b>GALLERY</b>	IMAGE FILES	n/a	View and manage images captured manually	
	LOG RESULTS	n/a	View and manage log files, images, videos captured while logging	
<b>IMAGE ADJUSTMENTS</b>	IMAGE MODES	n/a	Select MSX, IR Only, or a Visual mode	
	COLORS	n/a	Select Iron, White Hot, Black Hot, Rainbow, Lava, or Arctic	
	MEASURE- MENT	CENTER SPOT		Toggle cross-hairs ON/OFF
		EMISSIVITY		Select a preset or customize
		THERMO-COUPLE		Toggle ON/OFF

MAIN MENU	SUB MENU 1	SUB MENU 2	ACTION
<b>LOGGING</b>	TEMP SPOT	n/a	Set ON to start logging temperature readings. Specify time between readings
	TIME LAPSE IMAGING	n/a	Set ON to start capturing images and data logs. Specify time between captures
	VIDEO	n/a	Set ON to start recording video and data logs
	ALARM	n/a	Enable alarm, set thresholds and alert type
<b>LIGHT</b>	n/a	n/a	Toggle ON/OFF

MAIN MENU	SUB MENU 1	SUB MENU 2	ACTION
SETTINGS	DEVICE SETTINGS	BLUETOOTH	Toggle ON/OFF
		LASER	Toggle ON/OFF
		SCREEN BRIGHTNESS	Set Low, Medium, or High
		AUTO POWER OFF	Set to 5, 15, 30 minutes or 'Never' OFF
	GENERAL SETTINGS	TEMPERATURE UNIT	Select °C or °F
		TIME & DATE	Set time/date and format
		LANGUAGE	Select local language
		SYSTEM INFO	View serial number and other information
		GENERAL SYSTEM INFO	View regulatory information
		FACTORY RESET	Revert to factory default

# 8 Thermal IR Camera

---

## NOTE

- When measuring or charging for extended periods, the device's internal temperature can rise and impact the spot thermal sensor accuracy. Allow cool-down time between extended measurement and charging sessions.
- Using the device in areas where the ambient temperature is 113°F (45°C) for extended periods might affect the device's performance.
- The camera's reflected temperature setting is fixed at 77°F (25°C) and may differ from the actual reflected temperature.

### 8.1 Thermal Camera Basics

Thermal cameras show reflected infrared energy (heat) from scanned objects and surfaces. The camera has two thermal image modes, **IR only** and **MSX**. The camera defaults to the thermal **MSX** image mode.

To switch to the 'IR only' mode use the *IMAGE ADJUSTMENTS > IMAGE MODES* menu (Section 11.3). *MSX* (Multi-Spectral Dynamic Imaging) adds key details from the visual spectrum to the thermal image.

Note the color, brightness, and contrast variations in the thermal image. Generally, the brighter the area, the higher the temperature; the darker the area, the cooler the temperature. See the *COLORS* menu for more information (Section 11.3).

## 8.2 Thermal Camera Operation

1. Long press the Menu button to switch ON the camera. The FLIR logo will appear, followed by the camera image.
2. Point the camera, scan a test surface, and note the targeted temperature measurement on the display in °C or °F, see **Figure 8.1**. The temperature units can be changed in the *SETTINGS > GENERAL SETTINGS* menu (Section 11.6).

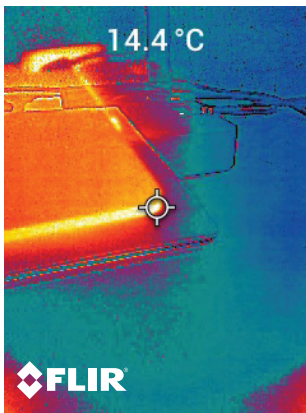

**Figure 8.1** Thermal camera image with targeted temperature reading.

3. Use the cross-hairs for reference targeting only, as parallax errors affect accuracy. Use the laser pointer for the highest accuracy. Enable the laser in the *SETTINGS > DEVICE SETTINGS* menu (Section 11.6).

4. With the laser enabled, press and hold the Laser button to switch it ON, and release it to switch it OFF. The laser's circular spot projection (**Figure 8.2**) indicates the area of the test surface whose temperature is displayed in °C or °F, using *Diffractive Optical Elements* (DOE) technology.

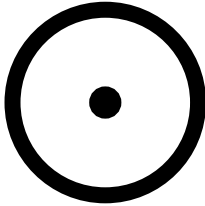

**Figure 8.2** Laser pointer temperature measurement spot.

5. Pull and release the trigger to capture the camera image. See Sections 10 and 11 for information on viewing and managing captured images.
6. To measure > 752°F (400°C) on the TG298 use the high temperature switch, see Section 13. The TG268 does not have a high temperature switch and cannot measure temperature > 752°F (400°C).
7. If a measurement is out of range, the temperature reading will indicate '**OL**'.

### 8.3 Distance-to-Spot Ratio

The distance-to-spot ratio is 24:1 (TG268) or 30:1 (TG298), see **Figure 8.3**.

For example, with a 24:1 distance-to-spot ratio, at a distance of 48 cm, the spot size would be 2 cm in diameter; at 96 cm the spot size would be 4 cm in diameter. The spot size increases as the distance from the targeted spot increases, and vice versa.

Note that the minimum target distance is 10.2 in. (26 cm).

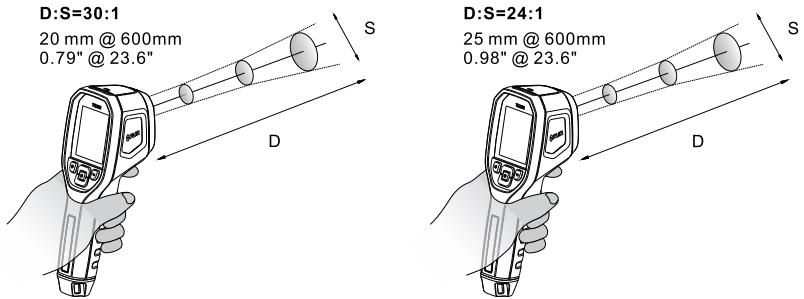

**Figure 8.3** The D:S ratio is 30:1 for the TG298 and 24:1 for the TG268.

# 9 Visual Spectrum Camera

---

## 9.1 Visual Camera Basics

The TG268 and TG298 each have a visual camera that offers standard (320 x 240 pixels) and high resolution (1600 x 1200 pixels) imaging. Visual images can also be superimposed on thermal images (MSX mode) to provide more detail in the thermal image (see Section 8.1, above). The temperature of targeted surfaces is measured and displayed in °C and °F.

## 9.2 Visual Camera Operation

1. Long press the Menu button to switch ON the camera.
2. Navigate to the *IMAGE MODES* menu (Menu button > *IMAGE ADJUSTMENTS* > *IMAGE MODES*) and use the arrow buttons to select the *VISUAL* or *HIGH RESOLUTION VISUAL* mode.
3. Pull and release the trigger to return to the normal operating mode.
4. Point the camera toward the test area and scan.
5. View the image on the display, see **Figure 9.1**. Note the temperature reading of the targeted spot.



**Figure 9.1** Visual spectrum camera image.

6. Use the cross-hairs for reference only, use the laser pointer for the highest accuracy. Enable the laser in the *SETTINGS* > *DEVICE SETTINGS* menu (Section 11.6).

7. With the laser enabled, press and hold the Laser button to switch it ON, and release it to switch it OFF. The laser's circular spot projection (**Figure 8.2**) indicates the area of the test surface whose temperature is displayed in °C or °F. For distance-to-spot ratio information, see Section 8.3, above.
8. Pull and release the trigger to capture the camera image. See Sections 10 and 11 for information on viewing and managing captured images.

# 10 Image Capture

---

The camera can store 50,000 images in \*.jpg format.

To capture an image, pull and release the trigger, while in the normal operating mode. If you pull the trigger while in the menu system, the display will simply return to the normal operating mode and no image will be captured.

When an image is captured successfully, the image filename will briefly appear at the top of the display.

Note that images captured in the *TIME LAPSE IMAGING* logging mode are handled differently, see Sections 11 and 12 for more information.

Saved images can be viewed on the camera, using the *GALLERY* menu (Section 11), shared with a mobile device (Section 15), and downloaded to a PC (Section 16).

Images cannot be captured if a USB cable is connected to the camera.

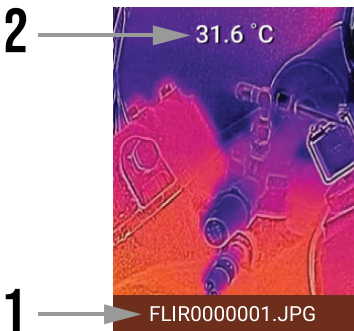

**Figure 10.1** Captured image as shown in the Gallery > Image Files menu. 1. Filename, 2. Temperature reading (recorded at the time the image was captured).

# 11 Menu System

---

## 11.1 Main Menu Basics

Refer to the reference map in Section 7, for a visual overview of the menu system.

The main menu has five (5) options: *GALLERY*, *IMAGE ADJUSTMENTS*, *LOGGING*, *LIGHT*, and *SETTINGS*.

- Short press the Menu button to access the main menu.
- Use the arrow buttons to scroll.
- Use the Menu button to select, toggle, or confirm settings.
- Use the Return button to return to the previous screen.
- Use the trigger to exit the menu.
- The menu is locked when the USB cable is connected to the camera.

## 11.2 GALLERY Menu

Press the Menu button at the *GALLERY* option to access the *IMAGE FILES* and *LOG RESULTS* submenus.

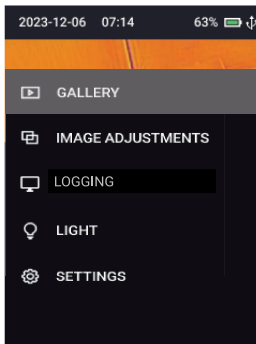

**Figure 11.1** Select GALLERY from the main menu.

Images captured manually, in the normal operating mode, are available in the *IMAGE FILES* submenu.

Time lapse images, videos, and data log files, captured in the logging mode, are available in the *LOG RESULTS* submenu. See Section 11.2.2 and Section 12 for additional information.

### 11.2.1 IMAGE FILES submenu

1. Press Menu at the *IMAGE FILES* submenu.
2. Use the arrows to browse the gallery and press Menu to open an image.
3. With an image opened, press Menu to access the options below.
  - *SEND*: Share selected image with a mobile device (Section 15).
  - *CANCEL*: Return to the opened image.
  - *DELETE*: Delete selected image.
  - *DELETE ALL FILES*: Delete all images in the *IMAGE FILES* gallery.

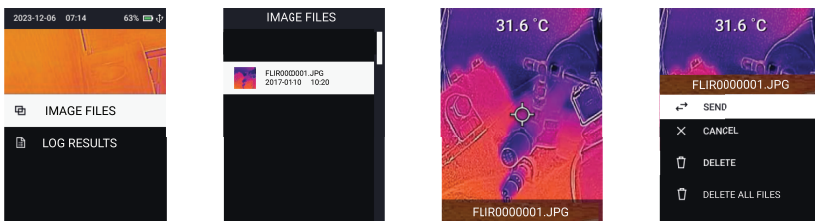

**Figure 11.2** IMAGE FILES sub-menus. From left to right, press Menu at the IMAGE FILES menu, scroll to an image and press Menu, press Menu on an opened image and select from the available options.

Images can also be downloaded to a PC, see Section 16.

### 11.2.2 LOG RESULTS submenu

The *LOG RESULTS* submenu, covered in the following sections, allows you to view and manage **data log files**, **time lapse images**, and **videos** captured from the logging mode. Images, videos, and data log files can be downloaded to a PC (Section 16) and shared with mobile devices (Section 15).

#### 11.2.2.1 LOG RESULTS (Data Log Files)

Data log files contain temperature measurements recorded using the *TEMP SPOT* logging function, explained in Section 12. Data log files are contained in folders (named Temp-Spot) in the Gallery, and are represented by the data log icon .

1. Press Menu at the *LOG RESULTS* submenu.
2. Scroll to a TEMP SPOT folder, and press Menu to open it. The sub-menu will open (View, Delete, Delete All Folders, Cancel).
3. Press Menu on the View option and scroll to a data log file , press Menu to open it.
4. Press Menu, while viewing a data log file, to access the options below.
  - *CHART*: View data log file as an x-y graph.
  - *SEND*: Share selected file with a mobile device (Section 15).
  - *CANCEL*: Return to the top level of the *LOG RESULTS* gallery.
  - *DELETE*: Delete selected data log file.
  - *DELETE ALL FILES*: Delete all data log files.

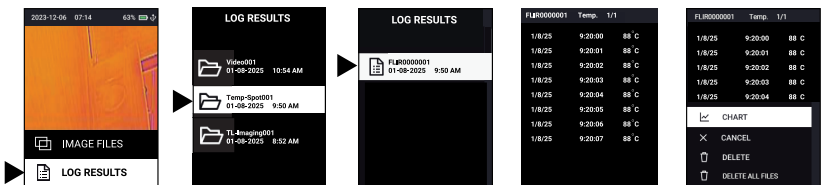
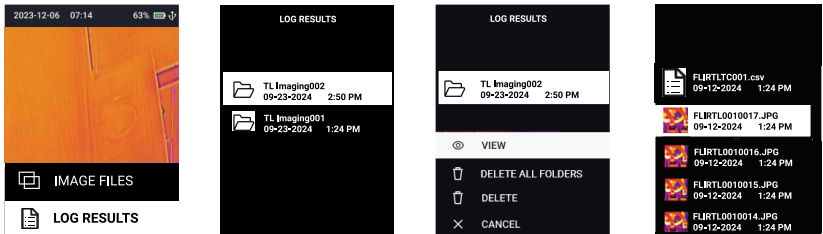

Figure 11.3 LOG RESULTS data log file navigation.

### 11.2.2.2 LOG RESULTS (Time Lapse Images)

Time lapse images and related data log files, captured in the logging mode (Section 12), are contained in folders (named TL-Imaging).

1. Press Menu at the *LOG RESULTS* submenu.
2. Scroll to a time lapse folder (TL-Imaging) and press Menu.
3. A sub-menu will open, press Menu on the *VIEW* option if you want to access the Time Lapse images and matching data logs. Press Menu on the Delete or Delete All Folders option if you want to delete the selected folder or all folders in the *LOG RESULTS* gallery.
4. While viewing the contents of the folder, scroll to an image file and press Menu to open it (data log files are explained in the previous section).
5. While viewing an image, press Menu to access the options below.
  - *SEND*: Share image with a mobile device (Section 15).
  - *CANCEL*: Press Menu to return to the opened image.
  - *DELETE*: Press Menu to delete the selected image.
  - *DELETE ALL FILES*: Press Menu to delete all image files in the folder.

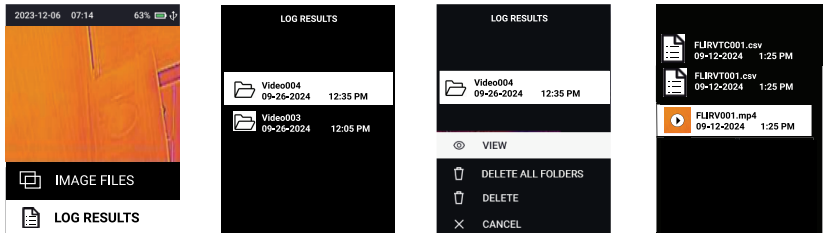

**Figure 11.4** LOG RESULTS time lapse image navigation. From left to right, press Menu at the LOG RESULTS option, scroll to a Time Lapse folder, press Menu, and select VIEW when prompted. A list of time lapse images and related data logs will open. Pressing Menu on an opened image or data file will show additional options.

### 11.2.2.3 LOG RESULTS (Videos)

Videos are captured in the logging mode (Section 12) and contained in folder in the gallery.

1. Press Menu at the *LOG RESULTS* submenu.
2. Scroll to a video folder and press Menu. Video folders are named 'Video'.
3. Press Menu on the *VIEW* option to access the videos and related data log files. Scroll to a video file (\*.mp4) and press Menu to start the video (data log files are explained, above, in Section 11.2.2.1).
4. While viewing a video, press Menu to access the options below.
  - *SEND*: Share video with mobile device (Section 15). This option only appears if videos are < 30 seconds in length.
  - *CANCEL*: Press Menu to return to the previous screen.
  - *DELETE*: Press Menu to delete the selected video folder.
  - *DELETE ALL FILES*: Press Menu to delete all video folders.



**Figure 11.5** LOG RESULTS video file navigation. From left to right, press Menu at the LOG RESULTS option, scroll to a Video folder, press Menu, and select VIEW when prompted. The Video and related data log files will open. Press Menu on a video file to play the video, press Menu to see more options.

### 11.3 IMAGE ADJUSTMENTS Menu

Press Menu at the *IMAGE ADJUSTMENTS* menu to access the *IMAGE MODES*, *COLORS*, and *MEASUREMENT* submenus.

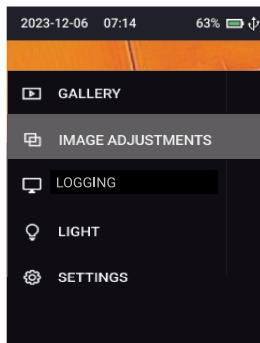

**Figure 11.6** Entering the IMAGE ADJUSTMENTS Menu.

#### 11.3.1 IMAGE MODES submenu

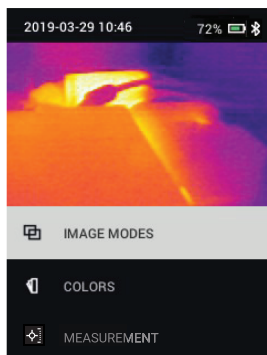

**Figure 11.7** Select IMAGE MODES from the IMAGE ADJUSTMENTS menu.

Press Menu at the *IMAGE MODES* submenu and scroll to an image mode using the arrows. The selected image mode name is shown at the top of the display.

The image mode options are *MSX*, *IR ONLY*, *VISUAL*, and *HIGH RESOLUTION VISUAL*. Scroll to the desired mode, using the arrow buttons, then press Menu to confirm. Pull the trigger to exit the menu.

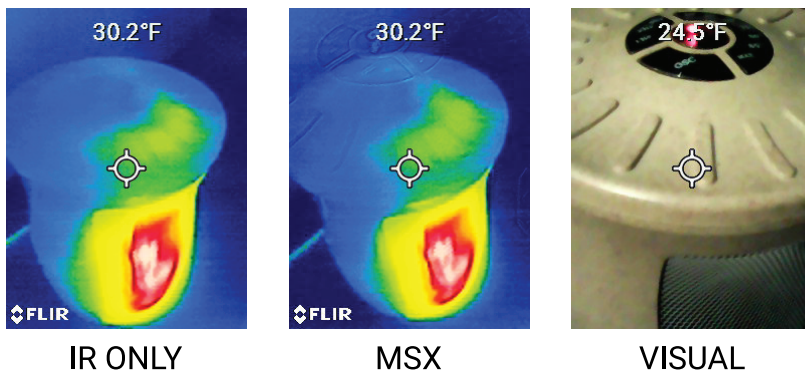
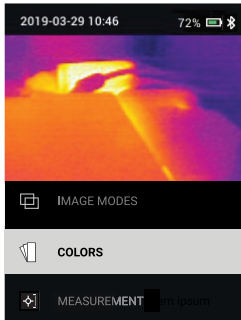

**Figure 11.8** Image Mode examples.

In the MSX mode, the visual camera image is superimposed on the thermal image, to create more detail. To align the two images, use the arrow buttons. Note that you can also adjust the MSX alignment directly from the normal operating mode, using the arrow buttons.



### 11.3.2 COLORS submenu



**Figure 11.9** Select **COLORS** from the **IMAGE ADJUSTMENTS** menu.

Press **Menu** at the **COLORS** submenu and use the arrows to select a color palette: **IRON**, **WHITE HOT**, **BLACK HOT**, **RAINBOW**, **LAVA**, or **ARCTIC**.

Press **Menu** to confirm and pull the trigger to exit the menu.

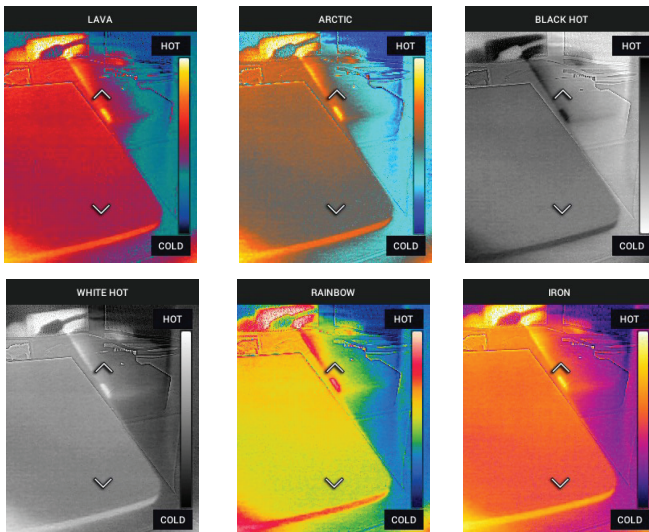

- **Arctic:** Warm objects appear gold in color, cooler objects appear in shades of blue.

- Iron, Rainbow, and Lava: Warm to cool temperature are represented by black and blue (coolest), magenta, orange, yellow to bright white (hottest).
- Black Hot: Warm objects appear black, and cool objects appear white.
- White Hot: Warm objects appear in white, and cool objects appear black.

### 11.3.3 MEASUREMENT submenu

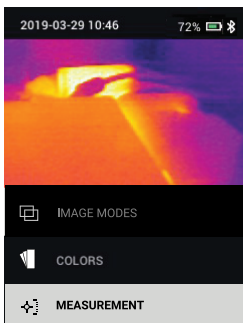
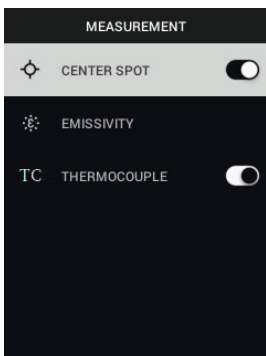

**Figure 11.10** Select MEASUREMENT from the IMAGE ADJUSTMENTS menu.

Press Menu at the *MEASUREMENT* submenu to access the *CENTER SPOT*, *EMISSIVITY*, and *THERMOCOUPLE* (TG268) options.

#### 11.3.3.1 CENTER SPOT

Press Menu at the *CENTER SPOT* submenu to switch the display cross-hairs ON or OFF. The cross-hairs roughly identify the measurement spot, use the laser pointer for precise targeting.



### 11.3.3.2 EMISSIVITY

Press Menu at the *EMISSIVITY* submenu. Use the arrows to scroll the presets and press Menu to confirm the selection.

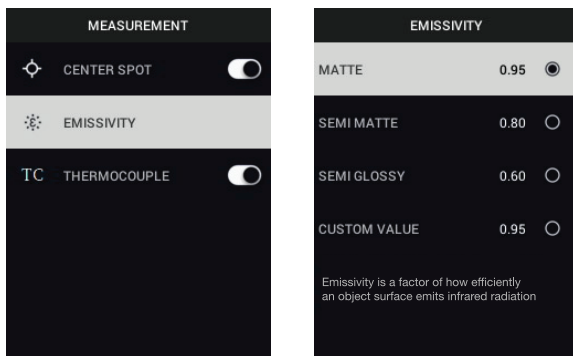

To set a specific emissivity, press Menu on the *CUSTOM VALUE* option, use the arrows to set the value, and press Menu to confirm.

### 11.3.3.3 THERMOCOUPLE (TG268 Only)

Press Menu at the *THERMOCOUPLE* submenu to toggle the thermocouple mode ON and OFF. When ON, and with a thermocouple connected, the display shows the thermocouple temperature measurement to the right of the 'TC' label (below the IR temperature measurement).

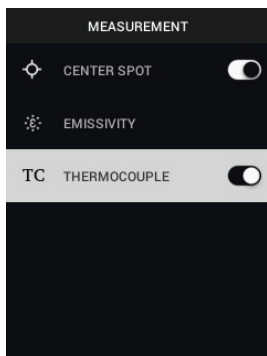

### 11.4 LOGGING Menu

See Section 12 for additional instructions on logging as it relates to condition monitoring. This section provides a brief overview of the menu.

1. Press Menu, scroll to the *LOGGING* option, and press Menu again to view the four logging functions *TEMP SPOT*, *TIME LAPSE IMAGING*, *VIDEO*, and *ALARM*. The following sections briefly outline each function.
2. Enable the *CENTER SPOT* display cross-hairs before continuing (Menu button > *IMAGE ADJUSTMENTS* > *MEASUREMENT* > *CENTER SPOT*).

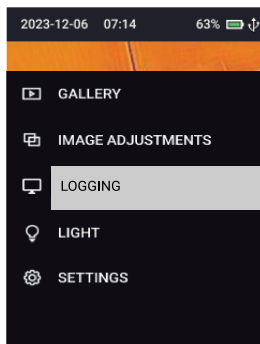
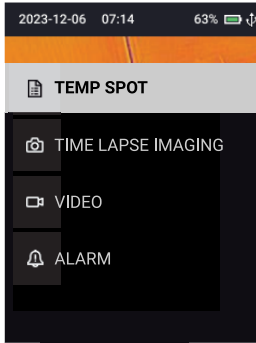

**Figure 11.11** Select LOGGING from the main menu.

Note that the *LOGGING* menu is not accessible when a USB cable is connected to the camera.

### 11.4.1 TEMP SPOT Submenu

The *TEMP SPOT* feature automatically logs temperature readings of a targeted spot, at the interval you specify (from 1 second to 5 minutes). This feature is explained in detail in Section 12, general information is provided below.



**Figure 11.12** Select TEMP SPOT from the LOGGING menu.

1. Press Menu at the *LOGGING > TEMP SPOT* submenu to open the option.
2. Select ON at the ON/OFF option to start logging. The display will prompt you to use the trigger to start and stop logging (*APO* is automatically disabled). Saved data log files are available in the *GALLERY > LOG RESULTS* menu (Section 11.2.2).
3. To set the data logger sampling interval, first switch the *TEMP SPOT* function OFF, and then scroll to the *TIME INTERVAL* option. Press Menu and set the interval (in minutes and seconds) using the Menu and arrow buttons.

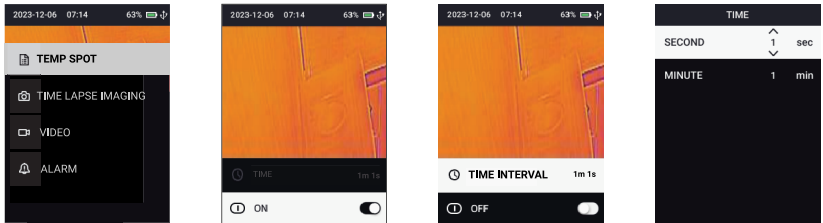
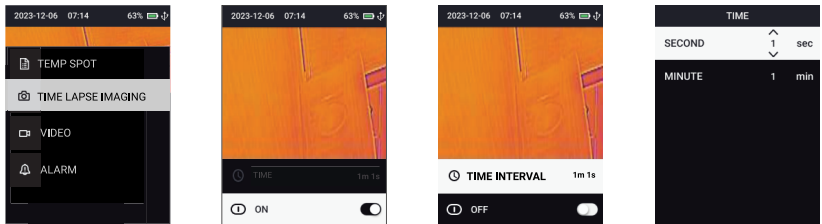

**Figure 11.13** Setting up the TEMP SPOT data logging function.

### 11.4.2 TIME LAPSE IMAGING Submenu

The *TIME LAPSE IMAGING* feature automatically captures images (and data log files) at the interval you specify (from 1 second to 5 minutes). This feature is explained in detail in Section 12, general information is provided below.

1. Press Menu at the *TIME LAPSE IMAGING* submenu.
2. Select ON at the ON/OFF option to start logging. The display will prompt you to use the trigger to start and stop logging. Saved images and data logs are available in the *GALLERY > LOG RESULTS* menu (Section 11.2.2).
3. To set the image capture sampling interval, before logging, first switch the *TIME LAPSE IMAGING* function OFF, and then scroll to the *TIME INTERVAL* option. Press Menu and set the sampling interval (in minutes and seconds) using the Menu and arrow buttons.

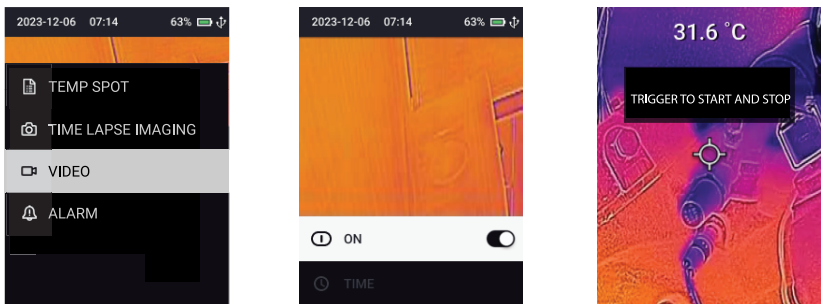

**Figure 11.14** Setting up the *TIME LAPSE IMAGING* data logging function.

### 11.4.3 VIDEO Submenu

The *VIDEO* feature records video while simultaneously logging temperature readings. This feature is explained in detail in Section 12, general information is provided below. Maximum video length is 50 minutes. Maximum video length is 30 seconds for mobile sharing.

1. Press Menu at the *VIDEO* submenu.
2. Press Menu to set the video mode *ON*, the display will prompt you to use the trigger to start and stop the video recording and simultaneous data logging.
3. Saved videos and data log files are available in the *GALLERY > LOG RESULTS* menu (Section 11.2.2).



**Figure 11.15** Start recording video and data logs.

#### 11.4.4 ALARM Submenu

The alarm alerts you when a temperature measurement reaches the high or low threshold. This feature is explained in detail in Section 12, general information is provided below.

1. Press Menu at the *ALARM* submenu.
2. Press Menu at the *THRESHOLD* option.
3. Press Menu to set the alarm ON or OFF.
4. When ON, scroll to an alarm threshold (HIGH or LOW) and press Menu.
5. Use the arrow buttons to set the threshold, press Menu to confirm.
6. Press Return and use the arrow buttons to scroll to an alert type, press Menu to confirm a selection (select any number of alert types).
7. To silence an alarm, press the Menu button (or disable the alarm function).

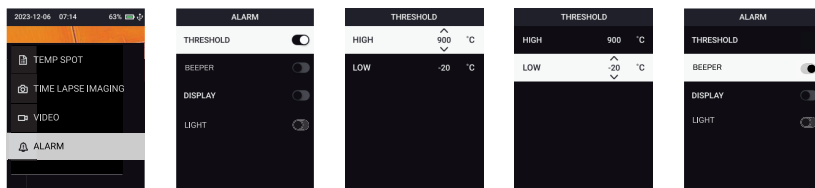

Figure 11.16 Configuring the high and low alarms.

#### 11.5 LIGHT Menu (Worklight)

Press Menu at the *LIGHT* menu selection to switch the worklight ON or OFF.

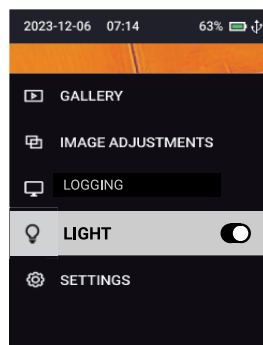
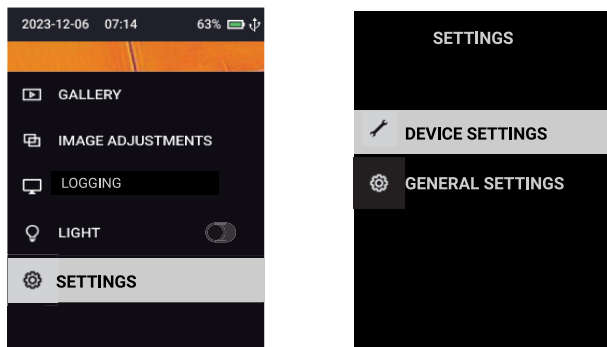

Figure 11.17 Switching the worklight ON and OFF from the main menu.

## 11.6 SETTINGS Menu

Press Menu at the *SETTINGS* option to access the *DEVICE SETTINGS* and the *GENERAL SETTINGS* submenus.



**Figure 11.18** Select *SETTINGS* form the main menu to access the *DEVICE* and *GENERAL SETTINGS* sub-menus.

### 11.6.1 *DEVICE SETTINGS* Submenu

Press Menu at the *DEVICE SETTINGS* submenu to access the *BLUETOOTH*, *LASER*, *SCREEN BRIGHTNESS*, and *AUTO POWER OFF* options.

#### 11.6.1.1 BLUETOOTH

Press Menu at the *BLUETOOTH* option to switch Bluetooth communication ON or OFF (see Section 15).

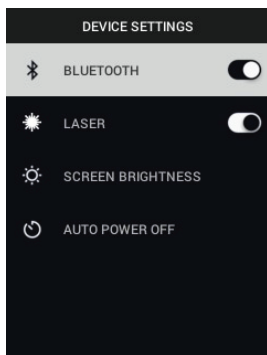

### 11.6.1.2 LASER

Press Menu at the *LASER* option to set the laser pointer ON or OFF. When ON, use the laser button to control the laser pointer. The laser is the most accurate way to target a spot. The temperature of the area within the laser's circular projection is shown as text on the display.

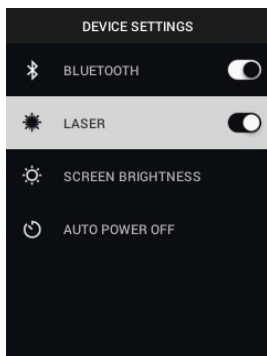

### 11.6.1.3 SCREEN BRIGHTNESS

Press Menu at the *SCREEN BRIGHTNESS* option and use the arrows to select the display intensity (*LOW*, *MEDIUM*, or *HIGH*).

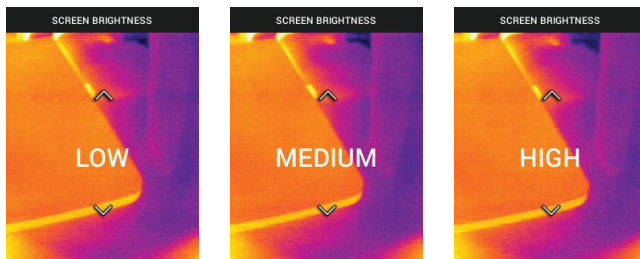

#### 11.6.1.4 AUTO POWER OFF

Press Menu at the *AUTO POWER OFF* option and use the arrows to scroll to 5, 15, 30 minutes or *NEVER* (to disable APO). Press Menu to confirm a selection. The Auto Power OFF function is automatically disabled when logging data, time lapse images, and videos.

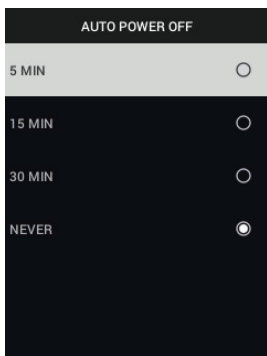

### 11.6.2 GENERAL SETTINGS Submenu

Press Menu at the *GENERAL SETTINGS* submenu to access the *TEMPERATURE UNIT*, *TIME & DATE*, *LANGUAGE*, *SYSTEM INFORMATION*, and *GENERAL SYSTEM INFORMATION* options.

#### 11.6.2.1 TEMPERATURE UNIT

Press Menu at the *TEMPERATURE UNIT* option and use the arrows to scroll to °C or °F. Press Menu to confirm.

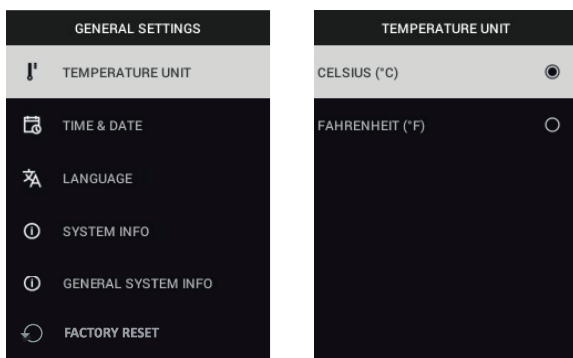

#### 11.6.2.2 TIME & DATE

Press Menu at the *TIME & DATE* option. Use the arrows to scroll and the Menu button to set the *TIME*, *DATE*, *TIME FORMAT*, and *DATE FORMAT*.

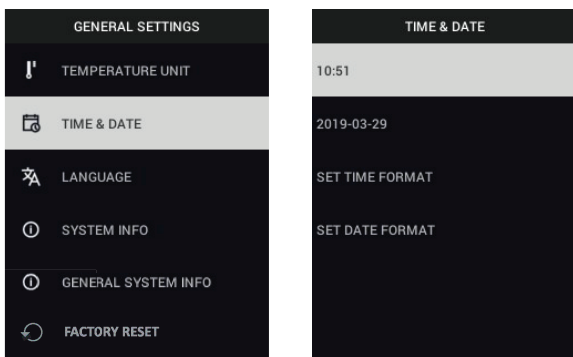

### 11.6.2.3 LANGUAGE

Press Menu at the *LANGUAGE* option. Use the arrows to scroll to a language, press Menu to confirm.

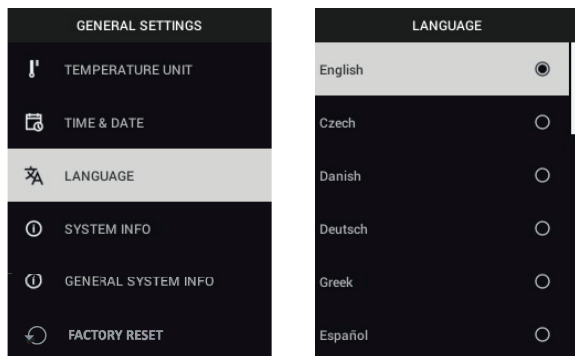

### 11.6.2.4 SYSTEM INFORMATION

Press Menu at the *SYSTEM INFO* option and view the camera's model number, serial number, software level, revision number, battery status (%), remaining internal memory storage (%), and last calibration date.

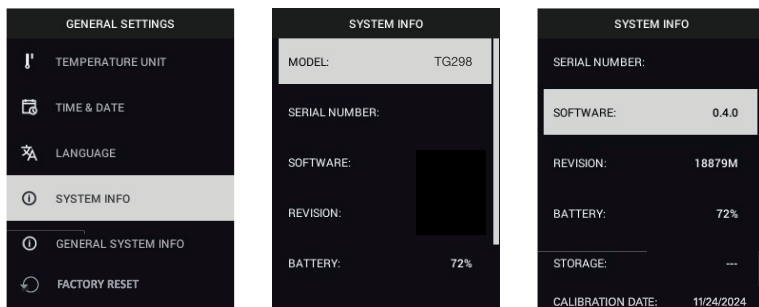

11.6.2.5 GENERAL SYSTEM INFORMATION

Press Menu at the *GENERAL SYSTEM INFO* option to view factory address and regulatory compliance information.



11.6.2.6 FACTORY RESET

Press Menu at the *FACTORY RESET* option and follow the display prompts to reset the device to its factory default state.

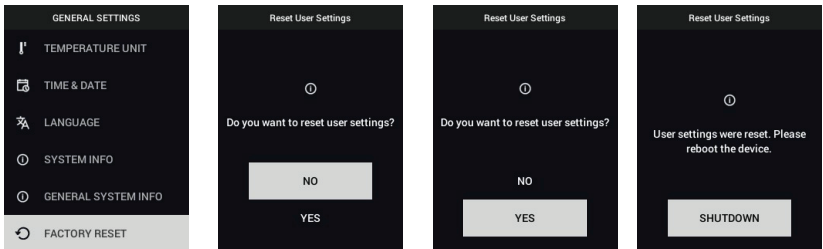

# 12 Condition Monitoring (Logging)

---

## 12.1 Condition Monitoring Overview

Condition monitoring is a preventative and predictive maintenance technique that helps detect potential faults in equipment.

By continuously monitoring the temperature and condition of equipment, deviations from normal operation can be discovered. Identifying issues in advance can help you strategically plan and schedule servicing, avoiding inopportune and costly downtime.

To begin, press the Menu button, scroll to the *LOGGING* option, and press Menu.

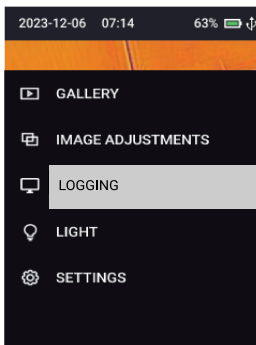

**Figure 12.1** The Logging selection in the main menu.

## 12.2 Condition Monitoring Tools

Condition monitoring can automatically log temperature readings (*TEMP SPOT* menu) and capture images (*TIME LAPSE IMAGES* menu). Condition monitoring also allows you to record video (*VIDEO* menu) and set a high/low temperature alarm (*ALARM* menu). Each tool is explained below, and in Section 11, *Menu System*.

### 12.3 Condition Monitoring — TEMP SPOT menu

The *TEMP SPOT* feature is a powerful data logger that automatically captures temperature readings, of a targeted spot, at the interval you specify (from 1 second to 5 minutes). For example, with the interval set to 5 seconds, one temperature reading will be logged every 5 seconds. When done, data log files are available from the *LOG RESULTS* submenu (in the *GALLERY* menu) as explained below.

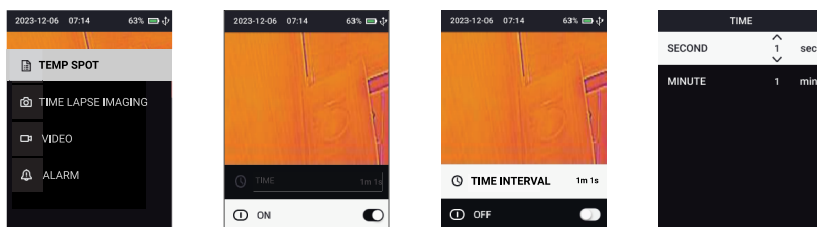



Figure 12.2 TEMP SPOT submenus.

1. Press the Menu button.
2. Scroll to *LOGGING*, and press Menu.
3. Press Menu at the *TEMP SPOT* option.
4. To start logging using the existing time interval, select *ON* at the *ON/OFF* option, the screen will prompt you to use the trigger to start and stop logging. The data log icon  will flash at the top right of the display while logging, and *APO* will be disabled.
5. To set the sampling time interval before logging, select *OFF* at the *ON/OFF* option, and continue with the steps below.
6. Scroll to *TIME INTERVAL*, and press Menu.
7. Press Menu at the *SECOND* option, and use the arrows to set the number of seconds, press Menu to confirm.
8. Scroll to the *MINUTE* option, and use the arrows to set the number of minutes, press Menu to confirm.

Data logs are available for viewing, sharing, and deleting in the *GALLERY* menu as explained below and in Section 11.

1. Press Menu and scroll to *GALLERY*, press Menu to open the Gallery.
2. Scroll to the *LOG RESULTS* option and press Menu.
3. Scroll to a *TEMP SPOT* folder, and press Menu to open it. The sub-menu will open (*View*, *Delete*, *Delete All Folders*, *Cancel*).

4. Press Menu on the View option and scroll to a data log file , press Menu to open it.
5. Press Menu to access the additional options, below.
  - CHART: Press Menu to view an x-y graph of the data log file.
  - SEND: Press Menu to share data log file with a mobile device (Section 15).
  - CANCEL: Press Menu to return to the opened data log file.
  - DELETE: Press Menu to delete the opened data log file.
  - DELETE ALL FILES: Press Menu to delete all data log files.

As explained in Section 16, the camera operates as a standard external storage drive when connected to a PC via the supplied USB cable. When connected, you can download data log text files (\*.csv) to your PC.

## 12.4 Condition Monitoring — TIME LAPSE IMAGING Menu

The camera can log images at a specified time interval (from 1 second to 5 minutes) for later viewing and managing, as explained below. Data log files are also created while capturing TIME LAPSE images. When done, time lapse images and data log files are available from the *LOG RESULTS* submenu (in the *GALLERY* menu) as explained below.

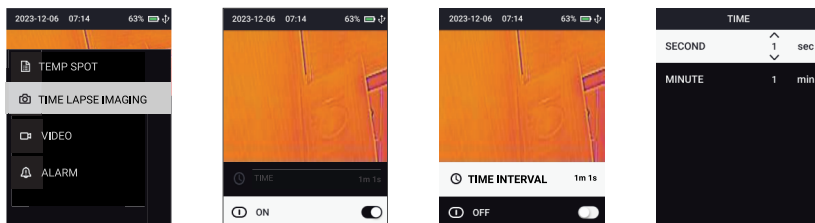



Figure 12.3 TIME LAPSE IMAGING submenu.

1. Press the Menu button.
2. Scroll to *LOGGING*, and press Menu.
3. Scroll to *TIME LAPSE IMAGING* and press Menu.
4. To start logging using the existing time interval, select *ON* at the *ON/OFF* option, the screen will prompt you to use the trigger to start and stop logging. The image  and data log  icons will flash at the top right of the display while logging, and *APO* will be disabled.
5. To set the sampling time interval before logging, select *OFF* at the *ON/OFF* option, and continue with the steps below.
6. Scroll to *TIME INTERVAL*, and press Menu.
7. Press Menu at the *SECOND* option, and use the arrows to set the number of seconds, press Menu to confirm.
8. Scroll to the *MINUTE* option, and use the arrows to set the number of minutes, press Menu to confirm.

Images (and data logs) are available for viewing, sharing, and deleting in the *GALLERY* menu, as explained below and in Section 11.

1. Press Menu, scroll to *GALLERY*, and press Menu.
2. Scroll to the *LOG RESULTS* option and press Menu.
3. Scroll to a time lapse folder (TL-Imaging) and press Menu.

4. A menu prompt will open, press Menu on the *VIEW* option to access the Time Lapse images and related data logs. Press menu on the Delete or Delete All Folders option to delete the selected folder or all folders in the *LOG RESULTS* gallery.
5. While viewing the contents of the folder, scroll to an image file and press Menu to open it (data log files are explained in the previous section).
6. While viewing an image, press Menu to access the options below.
  - SEND: Press Menu to share an image with a paired mobile device (Section 15).
  - CANCEL: Press Menu to return to the opened image.
  - DELETE: Press Menu to delete the opened image.
  - DELETE ALL FILES: Press Menu to delete all images in the folder.

To view and manage data log files, refer to Section 12.3, above.

As explained in Section 16, the camera operates as a standard external storage drive when connected to a PC via the supplied USB cable. When connected, you can download images to your PC.



## 12.5 Condition Monitoring — VIDEO Menu

To record video, proceed with the steps below. Data log files are simultaneously created while recording video. The data logger has a fixed sampling interval of 1 second in video mode. When done, video and data log files are available from the *LOG RESULTS* submenu (in the *GALLERY* menu) as explained below.

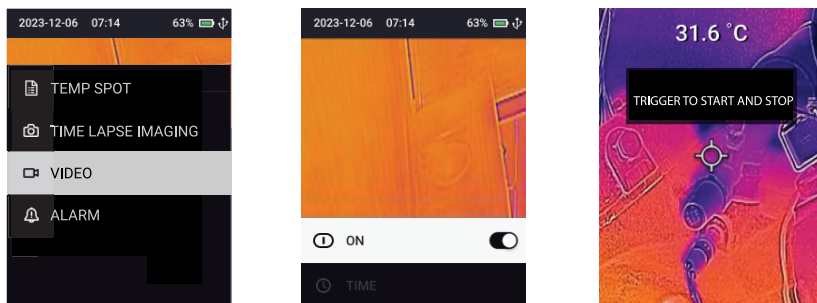
Maximum video length is 50 minutes. Maximum video length is 30 seconds for mobile sharing.



**Figure 12.4** The VIDEO submenus.

1. Press the Menu button.
2. Scroll to *LOGGING*, and press Menu.
3. Scroll to the *VIDEO* option and press Menu.
4. Press Menu to select ON.
5. The display will prompt you to use the trigger to start and stop recording video and data logging. APO will be automatically disabled.
6. The video recording icon  and data log  icons are shown at the top right of the display. The video timer (minutes and seconds) is also shown while recording.

Videos and data logs are available in the *GALLERY* menu under the *LOG RESULTS* submenu, as explained below and in Section 11. The instructions, below, apply to video management only. For data log file management, see Section 12.3, above.

1. Press Menu to open the main menu, and press Menu at the *GALLERY* option.
2. Scroll to the *LOG RESULTS* option and press Menu.
3. Scroll to a video folder (Video) and press Menu.

4. Press Menu on the *VIEW* option to access the videos and related data log files. Scroll to a video file (\*.mp4) and press Menu to start the video (data log files are explained, above, in Section 12.3 and in Section 11.2.2).
5. While viewing a video, press Menu to access the options below.
  - *SEND*: Share video with mobile device (Section 15). This option only appears if videos are < 30 seconds in length.
  - *CANCEL*: Press Menu to return to the previous screen.
  - *DELETE*: Press Menu to delete the selected video folder.
  - *DELETE ALL FILES*: Press Menu to delete all video folders.

As explained in Section 16, the camera operates as a standard external storage drive when connected to a PC via the supplied USB cable. When connected, you can download video and data log files to your PC.

## 12.6 Condition Monitoring — ALARM Menu

Set high and low temperature alarms that trigger audible and/or visual alerts when the measured temperature reaches a programmable threshold.

1. Press the Menu button.
2. Scroll to *LOGGING*, and press Menu.
3. Scroll to the *ALARM* option and press Menu.
4. Scroll to the *THRESHOLD* option and press Menu.
5. Press Menu to switch ON the alarm.
6. Scroll to *High*, and press Menu.
7. Use the arrows to select a high temperature threshold, press Menu to confirm.
8. Repeat these steps for the low temperature threshold.
9. Press Return and select the preferred alert method: audible beeper, flashing display, and/or flashing worklight.
10. Pull the trigger to exit. Now, when a measurement reaches the high or low threshold, the camera will issue an alert, using the method you have selected.
11. To silence an alarm, press Menu (note that the alarm will still be active but will not trigger until the measurement returns to normal range and then into a new alarm condition).
12. To disable the alarm completely, return to the *ALARM* menu, select *THRESHOLD*, and switch the alarm OFF.

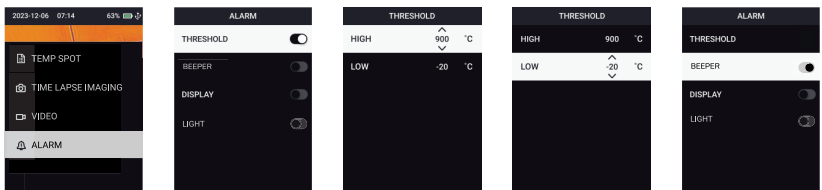
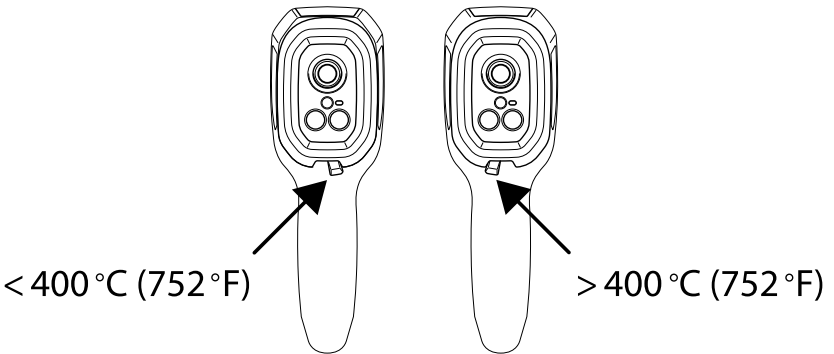

Figure 12.5 Configuring the high and low alarms.

# 13 High Temperature Switch (TG298)

The TG298 can measure the temperature of targeted surfaces from  $-13$  to  $+1976^{\circ}\text{F}$  ( $-25$  to  $+1080^{\circ}\text{C}$ ), but to measure  $> 752^{\circ}\text{F}$  ( $400^{\circ}\text{C}$ ), the high temperature protector switch must be engaged. The slide switch is located directly below the lenses, above the trigger.

Refer to **Figure 13.1**, below, for proper switch positioning for high and low temperature applications (the images, below, show the camera from the lens side). When the camera is in the high temperature mode, the 'H' icon will appear on the display, as shown in **Figure 13.2**.



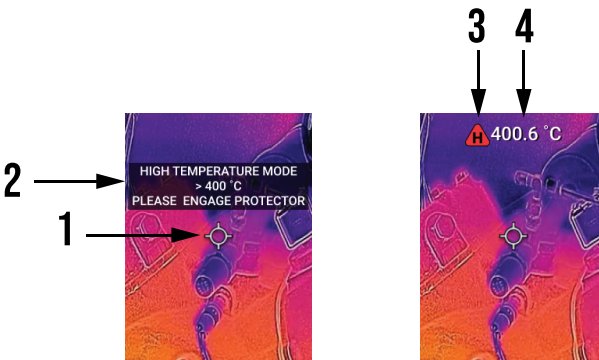

**Figure 13.1** TG298 high temperature switch.

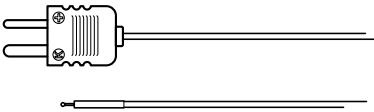

**Figure 13.2** 1. Targeted spot, 2. Alert message, 3. 'H' icon appears when switch is engaged, 4. Temperature measurement.

# 14 Type-K Thermocouple Measurements (TG268 Only)

 <b>WARNING</b>
The supplied thermocouple has a maximum temperature rating of 500°F (260°C). Measuring a higher temperature can damage the probe and the camera.
To avoid electrical shock, do not use this instrument when working near voltages > 24 V AC or DC. Do not allow the thermocouple to touch live circuitry.
To avoid damage and burns, do not make temperature measurements in microwave ovens.

 <b>CAUTION</b>
Repeated flexing can break the thermocouple leads. To prolong lead life, avoid sharp bends, especially near the connector.



**Figure 14.1** Supplied Type-K thermocouple (TG268)

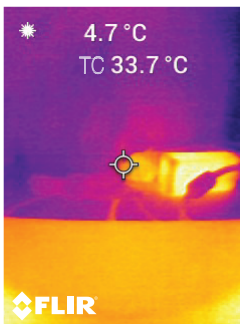

**Figure 14.2** Thermocouple temperature reading (33.7°C, in this example)

1. If necessary, enable the thermocouple in the *IMAGE ADJUSTMENTS > MEASUREMENT* menu (see Section 11). When the thermocouple is enabled, the 'TC' label is shown on the display.
2. Connect the thermocouple to the jack in the top compartment. Note that the thermocouple blades are dissimilar in size, this is to ensure correct polarity when connecting.

3. Touch the thermocouple probe tip to the surface under test or hold it in air. The temperature is shown next to the 'TC' label, see **Figure 8.2**.
4. Use the *SETTINGS > GENERAL SETTINGS* menu to select °C or °F temperature units (see Section 11.6).
5. If the thermocouple is not connected, or if the measurement is out of range, the display will show 'OL' next to the 'TC' label.
6. To find the optimum emissivity setting for a given surface, take an IR temperature measurement and then take a thermocouple measurement. Adjust the emissivity until the IR measurement equals the thermocouple measurement. Emissivity can be set in the *IMAGE ADJUSTMENTS > MEASUREMENTS* menu (see Section 11).

# 15 Bluetooth Communication and METERLiNK

---

## 15.1 Communication Overview

When paired with a mobile device running the METERLiNK mobile application, the TG298 and TG268 continually transmit readings for live display on a mobile device. You can also share stored images, videos, and data logs.

Videos longer than 30 seconds cannot be shared. Videos approaching 30 seconds can take up to 4 minutes to fully transmit.

## 15.2 Download METERLiNK

Download METERLiNK from Google Play™ or the Apple Store®.

## 15.3 Setting up METERLiNK

1. Switch the camera's Bluetooth function ON in the menu (*SETTINGS > DEVICE SETTINGS*).
2. Switch ON the mobile device and open the METERLiNK app.
3. METERLiNK will search for the camera (the camera must be ON). See **Figure 13.1**, below.
4. Tap the image of the TG298 or TG268 when METERLiNK finds it.
5. Complete instructions are included in the METERLiNK app, including contextual help and a user manual.

## 15.4 Share Images using Bluetooth

1. Open the camera's *GALLERY* from the main menu and scroll to an image using the arrow keys. See **Figures 13.2** and **13.3**, below.
2. Press Menu to open the selected image.
3. Press Menu again to open a submenu.
4. Scroll to the *SEND* command and press Menu.

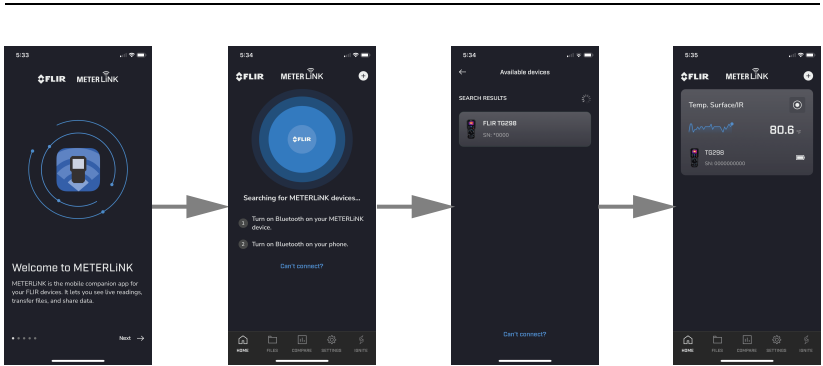

**Figure 15.1** When you open METERLiNK it will search for the camera. The camera must be ON and the Bluetooth function must be enabled in the SETTINGS menu.

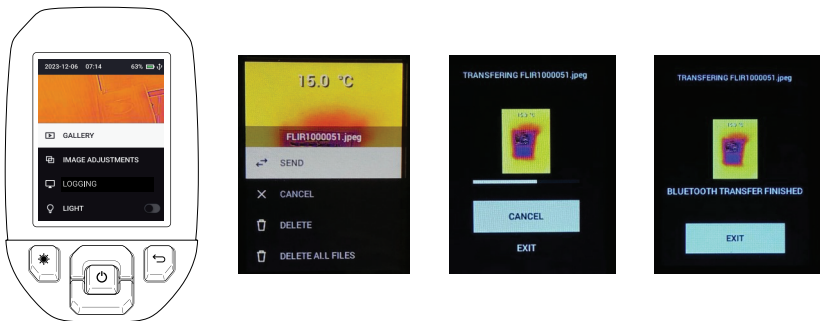

**Figure 15.2** Sharing images with a mobile device from the GALLERY menu.

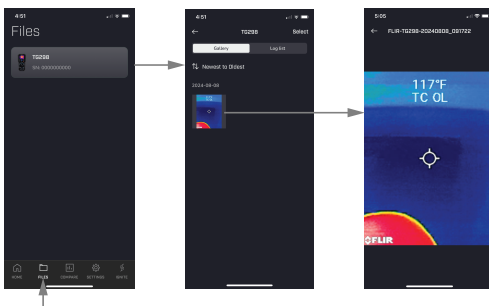

**Figure 15.3** Viewing shared images on a mobile device using METERLiNK. Tap FILES in the APP and then tap an image to open it.

### 15.5 Using the FLIR Ignite® Cloud

Ignite is secure backup solution offered by FLIR. Upload your METERLiNK files to the Ignite cloud and enjoy access to your files from anywhere. Ignite allows you to organize, collaborate, and create reports.

Ignite is available from within the METERLiNK app. There you can create an account and begin using the service immediately.

### 15.6 FCC Compliance

This device complies with part 15 of the FCC Rules. Operation is subject to the following two conditions:

1. This device may not cause harmful interference.
2. This device must accept any interference received, including interference that may cause undesired operation.

This equipment has been tested and found to comply with the limits for a Class B digital device, pursuant to part 15 of the FCC Rules. These limits are designed to provide reasonable protection against harmful interference in a residential installation. This equipment generates, uses, and can radiate radio frequency energy and, if not installed and used in accordance with the instructions, may cause harmful interference to radio communications. However, there is no guarantee that interference will not occur in a particular installation. If this equipment does cause harmful interference to radio or television reception, which can be determined by turning the equipment off and on, the user is encouraged to try to correct the interference by one or more of the following measures:

1. Reorient or relocate the receiving antenna.
2. Increase the separation between the equipment and receiver.
3. Connect the equipment into an outlet on a circuit different from that to which the receiver is connected.
4. Consult the dealer or an experienced radio/TV technician for help.

**WARNING**

Changes or modifications not expressly approved by the party responsible for compliance could void the user's authority to operate the equipment.

# 16 PC Interface

---

The camera can be connected to a PC using the supplied USB-C to USB-A cable. The USB-C port is accessible under the camera's protective flap at the top of the camera.

When connected to a PC, the camera operates as a standard external storage drive, allowing the transfer of images, videos, and data logs. The PC connection also allows you to update the camera's firmware, as explained in Section 17.

Note that when a USB cable is connected to the camera, the camera's menu is not accessible and the camera cannot capture images.

# 17 Field Firmware Updates

---

The camera includes a USB-C port in the top compartment. The USB port allows system firmware updates, as explained below. Firmware update files are available from <https://support.flir.com>.

## NOTE

This camera is not 100% compatible with USB-C to USB-C cables. Use only USB-C to USB-A cables. The supplied cable is USB-C to USB-A type.

To update the firmware, you will need:

- Access to the internet.
- TG298 or TG268 device.
- The system update file and/or the Lepton update file.

### 17.1 System Firmware Update

1. Visit <https://support.flir.com> to obtain firmware update files.
2. Select the *Downloads* tab and then select *Instrument Firmware (Test and Measurement)* from the drop-down menu.
3. Select the camera model from the second drop-down menu.
4. Select and download the firmware update files to the PC.
5. With the camera **ON** connect it to the PC via a USB-C cable (the USB-C port is located in the top compartment).
6. Copy the firmware and/or Lepton update files to the camera's root directory.
7. Disconnect the USB cable from the PC and from the camera.
8. Follow the camera's display prompts to complete the update.

# 18 Maintenance

---

## 18.1 Cleaning

Wipe the housing with a damp cloth as needed. Do not use abrasives or solvents. Clean the lenses with a high-quality lens cleaner and a lint-free swab.

## 18.2 Battery Considerations and Service

### NOTE

To comply with international transportation regulations, the meter is shipped with its battery charged to a maximum of 30%. The meter may show a low battery alert when it is received, it is recommended that the battery be charged to 100% before use.

The rechargeable lithium battery is not user-serviceable. Please contact FLIR support for service instructions: <https://support.flir.com>.

For best results, charge the battery immediately after seeing a low battery indication. If the battery is allowed to fully drain, it will take 2 to 3 hours before the charging display screen appear (after connecting the camera to the charger).

A full charge requires 4 hours, a charge to 90% power requires 3 hours. Charging through a PC USB port is not recommended.

When storing the camera for more than 3 months), first charge it to 70%, store it at room temperature, and recharge it every 6 months. Failure to do so can cause the battery to become inoperable.

## 18.3 Reset the Camera

If the camera display freezes or if the camera in any way stops operating normally, press and hold the up and down buttons for at least 10 seconds. Release the buttons when the camera switches OFF.

Switch ON the camera to resume use. No data will be lost by resetting the camera. If problems persist, contact FLIR for support.

# 19 Specifications

---

## 19.1 Imaging and Optical Specifications

IR resolution	160 x 120 pixels
Digital image enhancement	Included
Thermal Sensitivity /NETD	< 70 mK
Field of View (FOV)	57° (H) x 44° (D)
Minimum focus distance	1.6 ft. (0.5 m)
Distance-to-Spot ratio	30:1 for TG298 24:1 for TG268
Dual range operation (TG298)	Range 1: < 752°F (400°C) Range 2: > 752°F (400°C) For Range 2, the high temperature lever must be engaged
Focus	Fixed
Image frequency	8.7 Hz

## 19.2 Detector Specifications

Focal plane array /Spectral response range	Uncooled microbolometer /7.5 to 14 µm
Detector pitch	12 µm

## 19.3 Image Presentation Specifications

Display resolution	320 x 240 pixels
Screen size	2.4 in. (6.1 cm), portrait orientation
Viewing angle	80°
Color depth	24 bit
Aspect ratio	4:3
Display type	TFT technology

Image adjustment	Automatic
Image modes	Thermal MSX (Multi-Spectral Dynamic Imaging) Thermal IR only Visual Spectrum (standard and high resolution)

#### 19.4 Measurement Specifications

Object temperature range	TG298 -13 to +1976°F (-25 to +1080°C) Set the high temperature switch ON, for measurements > 752°F (400°C) TG268 -13 to +752°F (-25 to +400°C)
Accuracy at ambient temperature: 59 to 95°F (15 to 35°C)	-25°C to 0°C (±3.0°C) -13°F to 32°F (±7.0°F)
	0°C to 50°C (±2.5°C or ±2.5%)*
	32°F to 122°F (±5.0°F or ±2.5%)*
	50°C to 100°C (±2.0°C or ±2.0%)*
	122°F to 212°F (±5.0°F or ±2.0%)*
	100°C to 400°C (±2.5°C or ±2.5%)* 213°F to 752°F (±6.0°F or ±2.5%)*
IR Temperature resolution	TG298 only > 400°C (±3.0°C or ±3.0%)* > 752°F (±7.0°F or ±3.0%)*
Reading repeatability	0.2°F (0.1°C)
Response time	±1 % of reading
IR thermometer measurement	150 ms
Minimum measurement distance	Continuous scanning
	10 in. (26 cm)

\* Whichever is greater

### 19.5 Measurement Analysis Specifications

Spot meter	Center spot (cross-hairs); Programmable ON/OFF
Color display palettes	Iron, White Hot, Black Hot, Rainbow, Lava, and Arctic

### 19.6 Type-K Specifications (TG268 only)

Temperature range	-22°F to 734°F (-30.0°C to +390.0°C) <sup>1</sup>
Supplied thermocouple temperature range	500°F (260°C)
Error indication	<b>OL</b> is displayed if the thermocouple is not connected, defective, or if the measurement is out of range.
Type-K temperature Resolution	0.1°F (0.1°C)
Type-K temperature Accuracy	± (1% of reading + 5.4°F [3°C])
Maximum voltage for Type-K input	60 V DC or 24 V AC RMS

1. The temperature range of the supplied thermocouple is 500 F (260 C). To measure a higher temperature, please use a thermocouple rated for higher ranges.

### 19.7 Configuration Specifications

Set-up commands	Local adaptation of units, language, date and time formats
Emissivity adjustment	Four (4) presets plus a custom adjustment utility (0.1 to 0.99)
Languages	Czech, Danish, Dutch, English, Finnish, French, German, Greek, Hungarian, Italian, Japanese, Korean, Norwegian, Polish, Portuguese, Russian, simplified Chinese, Spanish, Swedish, traditional Chinese, Turkish
Firmware updates	User manageable (instructions included in this user manual)

### 19.8 Image, Video, and Data Log Storage Specifications

Storage media	eMMC 8G
Image storage capacity	> 50 k images
Image file format	JPEG with spot temperature metadata tag

Video storage capacity	Up to 50 minutes per video
Video file format	mp4
Video resolution	240 x 320 pixels
Data log storage	Text files *.csv

### 19.9 Digital Camera Specifications

Resolution	Standard visual camera mode: QVGA 320 x 240 pixels High resolution visual camera mode: 2M (1600 x 1200 pixels)
Focus	Fixed
Field of View (FOV)	71° (H) x 56° (V)

### 19.10 Worklight Specifications

Worklight type	Bright LED
LED CCT	6500° K
LED CRI	70
Beam angle	± 20°
Rated power	0.5 W
Light output	100 Lumens

### 19.11 Laser Pointer Specifications

Laser type	DOE (Diffractive Optical Elements)
Laser function	Indicates the size of the measurement area (circular target)
Laser class	Class 1

### 19.12 Data Communication and Interface Specifications

Interfaces	Bluetooth BLE
USB	USB-C for data transfer and battery charging Not 100% compatible with USB-C to USB-C cables. Use only a USB-C to USB-A cable.
USB standard	USB 2.0 High Speed

### 19.13 Battery Specifications

Battery type	Rechargeable Lithium ion
Battery voltage	3.6 V
Battery operating time	8 hours maximum scanning (medium brightness setting) 7.5 hours maximum with laser ON (medium brightness setting)
Battery charge life	30 days minimum
Charging system	Battery is charged inside the camera
Charging time	3 hours to 90% 4 hours to 100%
Power management	APO adjustable 5/15/30 minutes. Can be disabled.

### 19.14 Environmental Specifications

Operating temperature	32 to 113°F (0 to 45°C)
Storage temperature	-22 to 131°F (-30 to 55°C)
Humidity (operating and storage)	0 to 90% RH: 32 to 98.6°F (0 to 37°C) 0 to 65% RH: 98.6 to 113°F (37 to 45°C) 0 to 45% RH: 113 to 131°F (45 to 55°C)
CE /RF /EMC	EN 61326-1:2013 EN 55011:2016 + A1 EN 61000-6-2 EN 61000-6-3 RF /EMC: EN 301489, EN 300328 FCC 47 CFR Part 15 Class B
Magnetic fields	EN 61000-4-8 Class 3
Radio spectrum	ETSI EN 300 328 FCC Part 15.249 RSS-247 Issue 2 EN 301 489-1:2011 EN 301 489-17:2009

Encapsulation	IP 54 (IEC 60529)
Shock	25 g (IEC 60068-2-27)
Vibration	0.15 mm, 2 g (IEC 60068-2-6)
Drop	Designed for 6.56 ft. (2 m)
Safety	CE /CB /EN61010
Environmental	REACH: SVHC 30 2024/01/23 (240 Substance) RoHS: Directive 2015/863/EU + Packing 94/62/EC + Battery (EU)2023/1542 FRANCE Minal Oil ban law Arrêté du 13 avril 2022 (Article 112 od decree no. 2020-105) WEEE- Directive 2012/19/EC IEC 60825-1:2014 EN 60825-1:2014+A11:2021 FDA laser CA65
Humidity requirements	IEC 60068-2-30 / 24h 95% RH +25 to +70°C / 2 Cycles (Storage) IEC 60068-2-30 / 24h 95% RH +25 to +40°C / 2 Cycles (Operating)
Indoor, outdoor use	For indoor use only
Altitude	6561 ft. (2000 m) maximum
Pollution degree of intended environment	2

### 19.15 Physical Specifications

Weight	0.86 lbs. (390 g)
Size (L x W x H)	8.3 x 2.5 x 3.2 in. (210 x 64 x 81 mm)
Accessory mount	UNC ¼"-20

### 19.16 Included Equipment

Standard equipment	Camera, USB-C/A cable, printed Quick Start Guide, Lanyard, Carry Pouch, Type-K Thermocouple (TG268 only)
--------------------	--

# 20 Limited 10-Year Warranty

---

This product is protected by FLIR's Limited 10-Year Warranty. Visit [www.flir.com/testwarranty](http://www.flir.com/testwarranty) to read the Limited 10-Year Warranty document.

# 21 Customer Support

---

Customer Support Telephone List	<a href="https://support.flir.com/contact">https://support.flir.com/contact</a>
Repair, Calibration, and Technical Support	<a href="https://support.flir.com">https://support.flir.com</a>





---

**Website**

<http://www.flir.com>

**Customer support**

<http://support.flir.com>

**Copyright**

© 2025, FLIR Systems, Inc. All rights reserved worldwide.

**Disclaimer**

Specifications subject to change without further notice. Models and accessories subject to regional market considerations. License procedures may apply. Products described herein may be subject to US Export Regulations. Please refer to [exportquestions@flir.com](mailto:exportquestions@flir.com) with any questions.

Publ. No.: NAS100221  
Release: AC  
Commit: 104738  
Head: 104748  
Language: en-US  
Modified: 2025-05-01  
Formatted: 2025-05-01

